

A Complete Genealogy Report For

JAMES KENNADAY

Created on 20 February 2009
"The Complete Genealogy Reporter"
© 2006-2007 Nigel Bufton
under license to MyHeritage Family Tree Builder



CONTENTS

1. PATERNAL ANCESTRY.
2. MATERNAL ANCESTRY.
3. DESCENDANTS.
4. DIRECT RELATIONS.
5. INDIRECTLY RELATED via BETTY CAROL FITZPATRICK.
6. INDIRECTLY RELATED via JOHN DAVID KELLEY.
7. INDIRECTLY RELATED via BRUCE DOUGLAS WHITMAN.
8. INDIRECTLY RELATED via MABLE PIERCE.
9. INDIRECTLY RELATED via FRANCES ELIZABETH KENNEDY.
10. INDIRECTLY RELATED via ANNE ELIZABETH VAN ORSDEL.
11. INDIRECTLY RELATED via MARY ELIZABETH SKELTON.
12. INDIRECTLY RELATED via CRISTINE SAPP.
13. INDIRECTLY RELATED via BETTY EARLYWINE.
14. FAMILY TREES.
15. INDEX OF PLACES.
16. INDEX OF DATES.
17. INDEX OF INDIVIDUALS.

1. PATERNAL ANCESTRY

2. MATERNAL ANCESTRY

3. DESCENDANTS

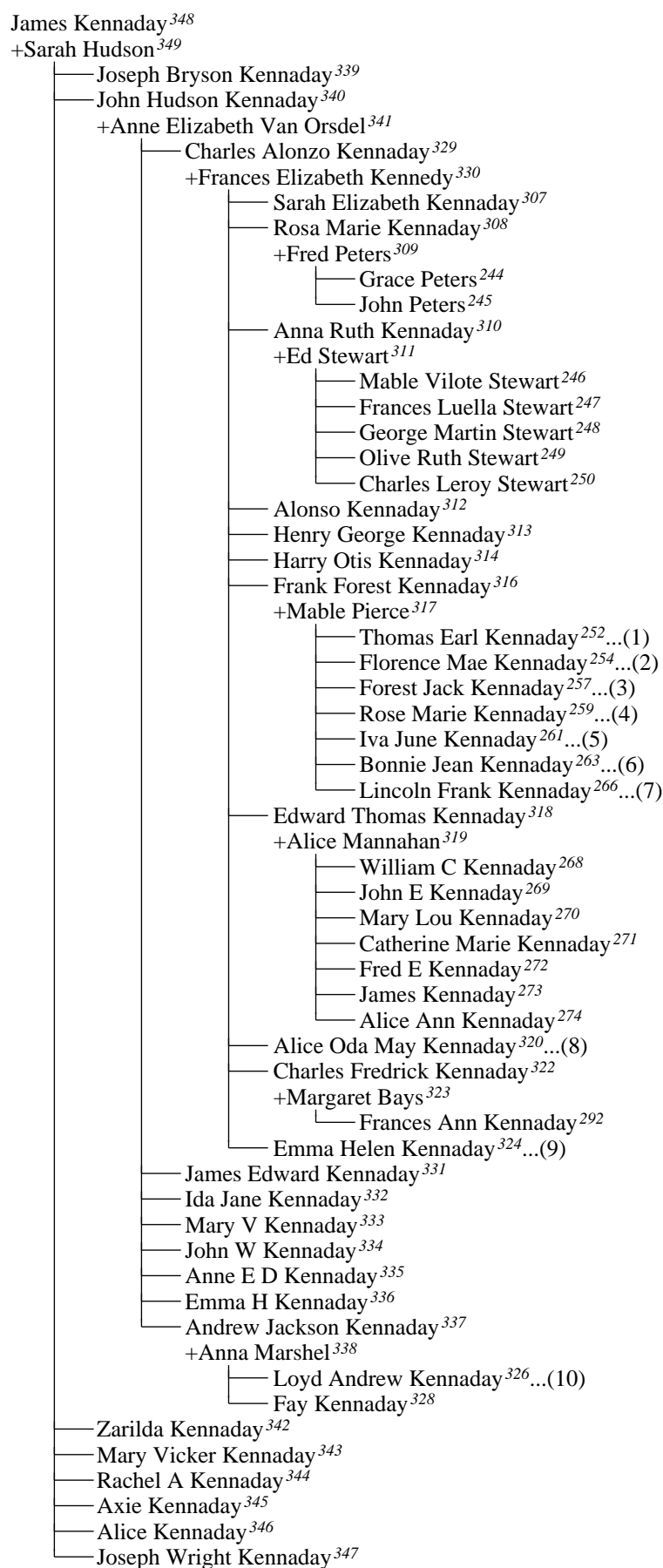

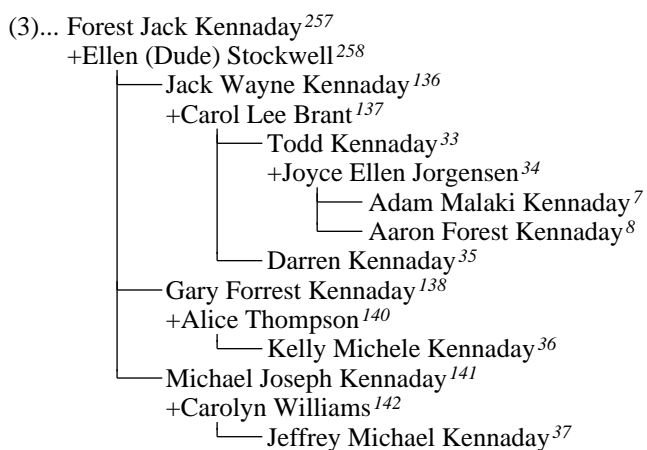
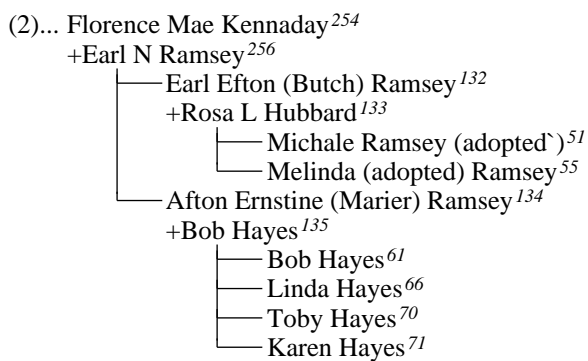
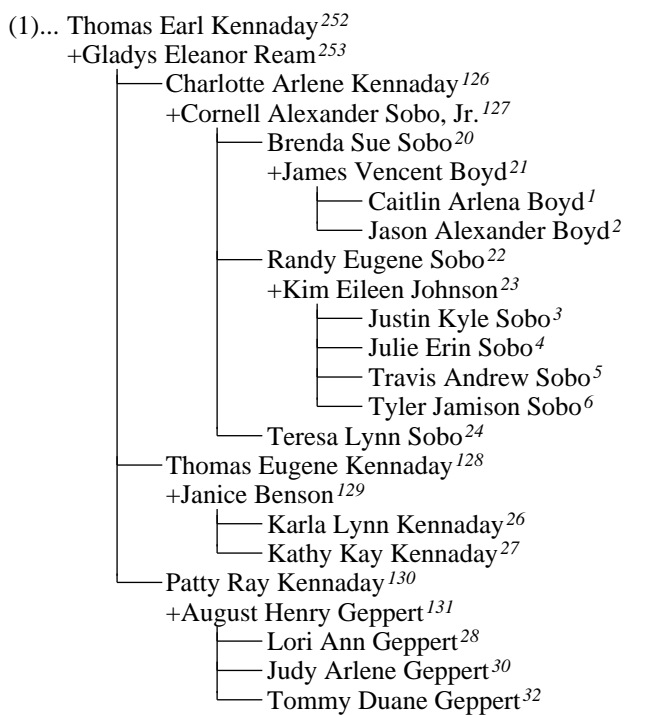

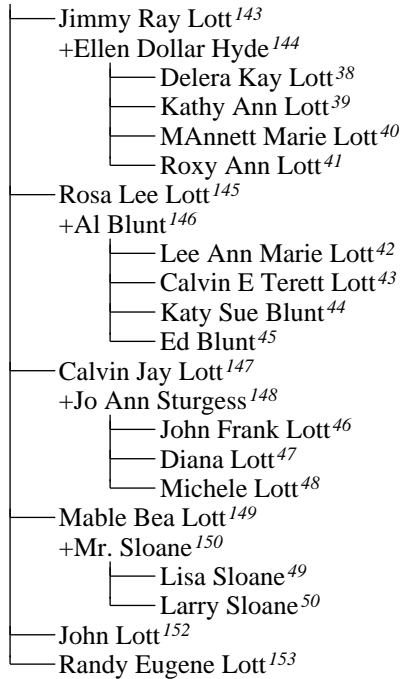
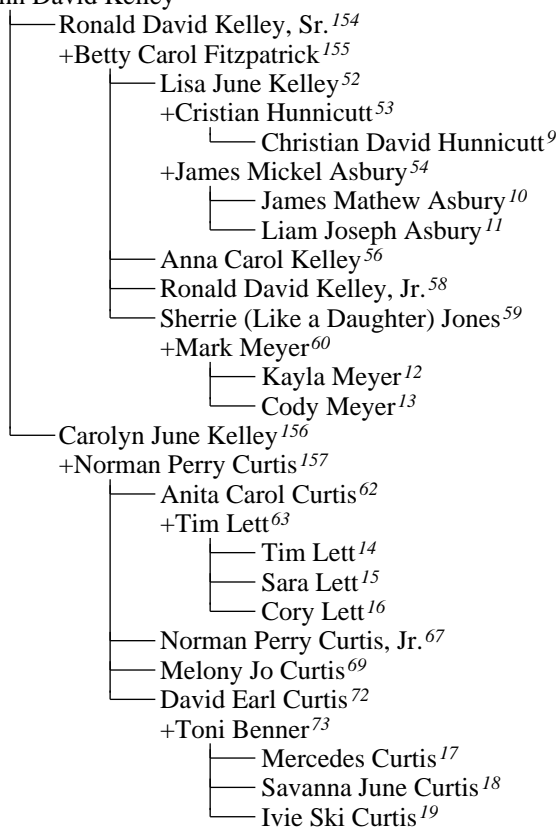
(4)... Rose Marie Kennaday²⁵⁹+Calvin Lott²⁶⁰(5)... Iva June Kennaday²⁶¹+John David Kelley²⁶²

- (6)... Bonnie Jean Kennaday²⁶³
 +Gordon Johnson²⁶⁴
 └── Stanley Johnson¹⁵⁸
 └── Scott Johnson¹⁵⁹
 +James Martin Marier²⁶⁵
 └── Sherry Jean Marier¹⁶⁰
 └── +Gordon Johnson¹⁶²
 └── Gordon Scott (Scotty) Johnson⁸²
 └── Stanley (Stan) Johnson⁸³
 └── Jane Marie Marier¹⁶³
 └── +Micheal A Forrester¹⁶⁴
 └── Mike Allen Forrester, Jr.⁸⁴
 └── Tommy James Forrester⁸⁵
 └── Jamie Forrester⁸⁶
- (7)... Lincoln Frank Kennaday²⁶⁶
 +Joan Olivia Debernardi²⁶⁷
 └── Gary Jo Kennaday¹⁶⁵
 └── David Debernardi Kennaday¹⁶⁷
 └── +Paula Jo Smith¹⁶⁸
 └── Nicholas Isaiah Kennaday⁷⁴
 └── Elizabeth Alta Olivia Kennaday⁷⁵
 └── Cristina Dianne Kennaday⁷⁶
 └── Steven Scott Kennaday¹⁶⁹
 └── +Catherine Susan Lavelle¹⁷⁰
 └── Joshua Jolin Kennaday⁷⁷
 └── +Danielle Reed¹⁷¹
 └── Mallory Kennaday⁷⁸
 └── Reed Kennaday⁷⁹
 └── Fredrick Frank Kennaday¹⁷²
 └── +Brigid Ann Young¹⁷³
 └── Patricia Leigh Kennaday⁸⁰
 └── Anthony Joseph Kennaday⁸¹

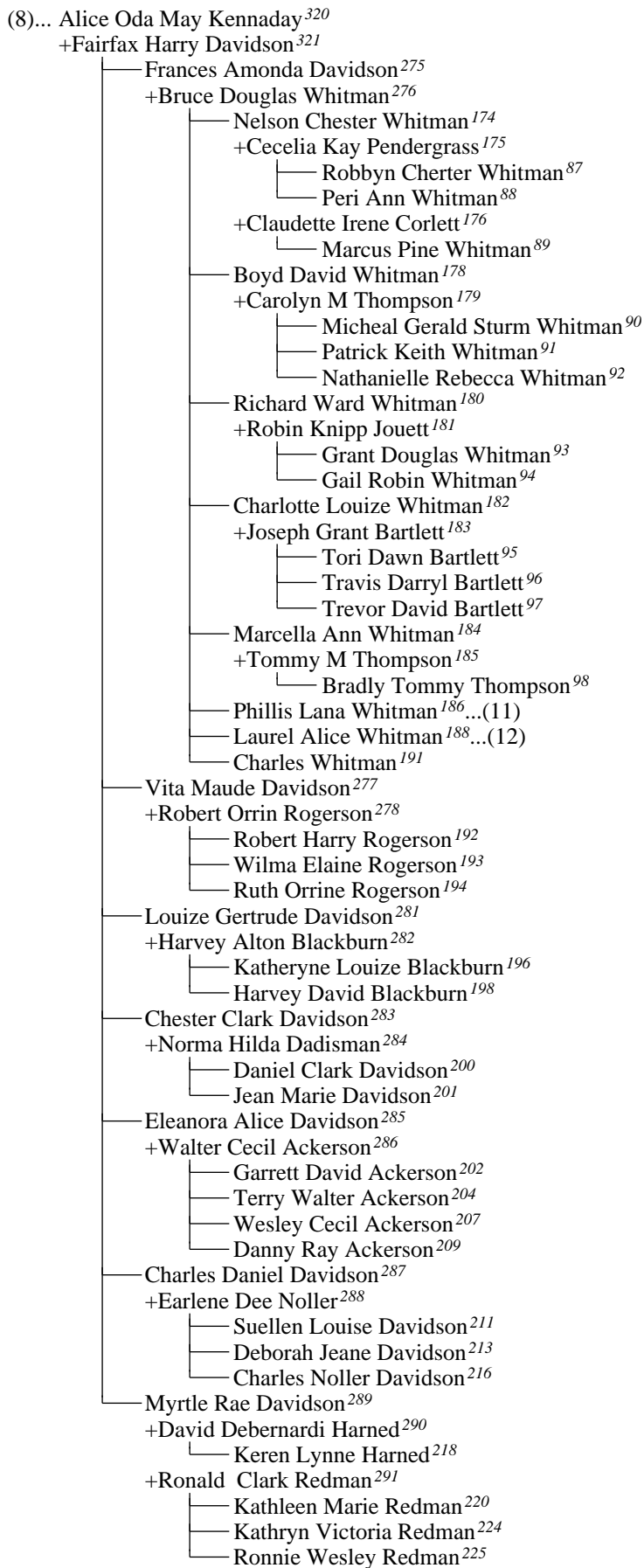

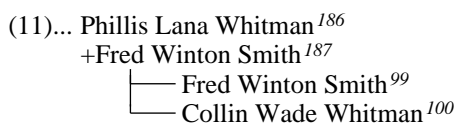
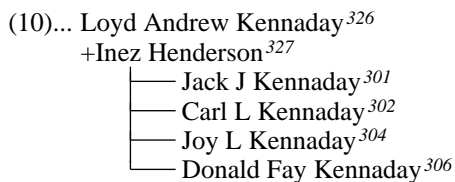
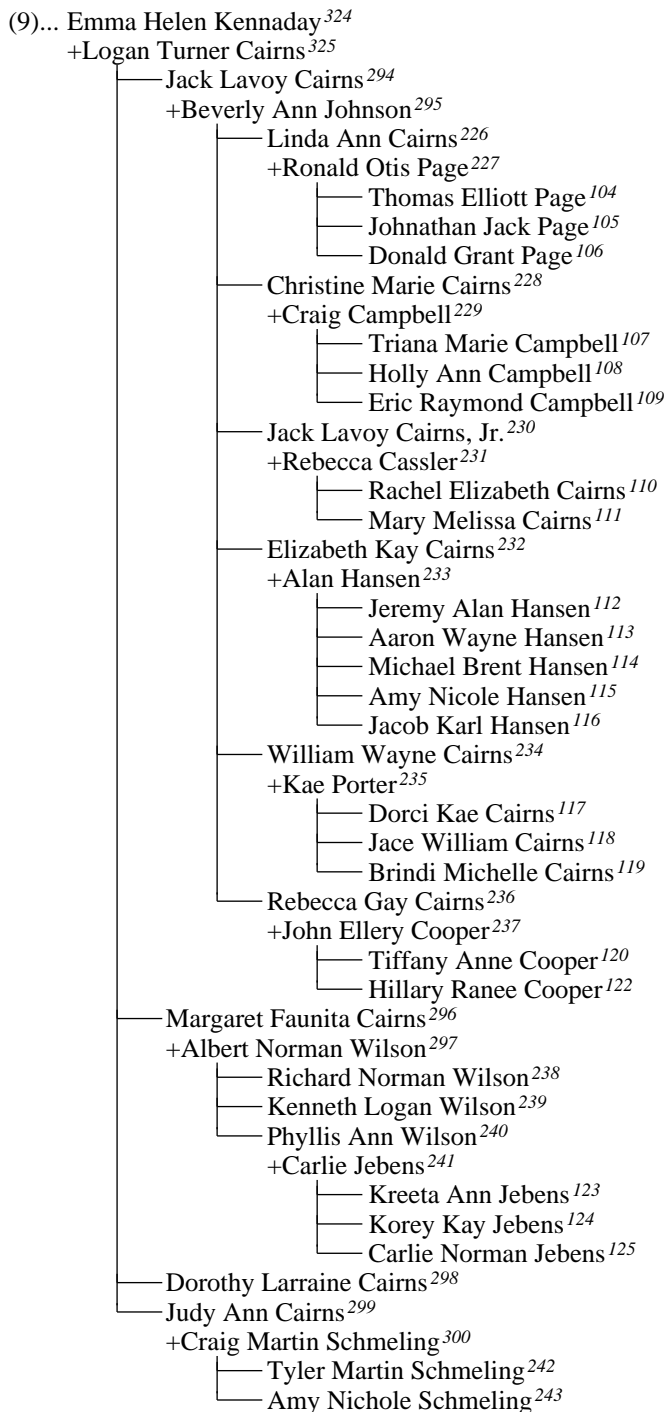

(12)... Laurel Alice Whitman¹⁸⁸
+Stanley Howard Self¹⁸⁹
├— Stuart Branson Self¹⁰¹
├— Ian Mathew Self¹⁰²
└— Ashley Chester Self¹⁰³

4. DIRECT RELATIONS

Generation of Five-Times-Great-Grandchildren

1. CAITLIN ARLENA BOYD (James's five-times-great-granddaughter) was born in 1992 in Managua, Nicaragua to James Vencent Boyd²¹ and Brenda Sue Sobo²⁰, as shown in family tree 1.
2. JASON ALEXANDER BOYD (James's five-times-great-grandson) was born in 1994 to James Vencent Boyd²¹ and Brenda Sue Sobo²⁰, as shown in family tree 1.
3. JUSTIN KYLE SOBO (James's five-times-great-grandson) was born in 1982 in Medford, Jackson, Oregon, USA to Randy Eugene Sobo²² and Kim Eileen Johnson²³, as shown in family tree 2.
4. JULIE ERIN SOBO (James's five-times-great-granddaughter) was born in 1985 in Medford, Jackson, Oregon, USA to Randy Eugene Sobo²² and Kim Eileen Johnson²³, as shown in family tree 2.
5. TRAVIS ANDREW SOBO (James's five-times-great-grandson) was born in 1987 in Medford, Jackson, Oregon, USA to Randy Eugene Sobo²² and Kim Eileen Johnson²³, as shown in family tree 2.
6. TYLER JAMISON SOBO (James's five-times-great-grandson) was born in 1987 in Medford, Jackson, Oregon, USA to Randy Eugene Sobo²² and Kim Eileen Johnson²³, as shown in family tree 2.
7. ADAM MALAKI KENNADAY (James's five-times-great-grandson) was born in 1987 in Anaheim, Orange, California, USA to Todd Kennaday³³ and Joyce Ellen Jorgensen³⁴, as shown in family tree 3.
8. AARON FOREST KENNADAY (James's five-times-great-grandson) was born in 1990 in Anaheim, Orange, California, USA to Todd Kennaday³³ and Joyce Ellen Jorgensen³⁴, as shown in family tree 3.
9. CHRISTIAN DAVID HUNNICUTT (James's five-times-great-grandson) was born on 10 January 1983 in Indianapolis, Indiana, USA to Cristian Hunnicutt⁵³ and Lisa June Kelley⁵², as shown in family tree 4.
10. JAMES MATHEW ASBURY (James's five-times-great-grandson) was born on 28 June 1991 in Lexington, Kentucky, USA to James Mickel Asbury⁵⁴ and Lisa June Kelley⁵², as shown in family tree 5.
11. LIAM JOSEPH ASBURY (James's five-times-great-grandson) was born to James Mickel Asbury⁵⁴ and Lisa June Kelley⁵², as shown in family tree 5.
12. KAYLA MEYER (James's five-times-great-granddaughter) was born to Mark Meyer⁶⁰ and Sherrie (Like a Daughter) Jones⁵⁹, as shown in family tree 6.
13. CODY MEYER (James's five-times-great-grandson) was born to Mark Meyer⁶⁰ and Sherrie (Like a Daughter) Jones⁵⁹, as shown in family tree 6.
14. TIM LETT (James's five-times-great-grandson) was born to Tim Lett⁶³ and Anita Carol Curtis⁶², as shown in family tree 7.
15. SARA LETT (James's five-times-great-granddaughter) was born to Tim Lett⁶³ and Anita Carol Curtis⁶², as shown in family tree 7.
16. CORY LETT (James's five-times-great-grandson) was born to Tim Lett⁶³ and Anita Carol Curtis⁶², as shown in family tree 7.
17. MERCEDES CURTIS (James's five-times-great-granddaughter) was born in August 1994 in Indianapolis, Marion, Indiana, USA to David Earl Curtis⁷² and Toni Benner⁷³, as shown in family tree 8.
18. SAVANNA JUNE CURTIS (James's five-times-great-granddaughter) was born on 14 June 1995 in Indianapolis, Marion, Indiana, USA to David Earl Curtis⁷² and Toni Benner⁷³, as shown in family tree 8.
19. IVIE SKI CURTIS (James's five-times-great-granddaughter) was born on 11 November 1996 to David Earl Curtis⁷² and Toni Benner⁷³, as shown in family tree 8.

Generation of Four-Times-Great-Grandchildren

20. BRENDA SUE SOBO (James's four-times-great-granddaughter) was born on 22 March 1958 in Klamath, Falls, Klamath, Organ, USA to Cornell Alexander Sobo, Jr.¹²⁷ and Charlotte Arlene Kennaday¹²⁶, as shown in family tree 9.
21. JAMES VENCENT BOYD (James's four-times-great-granddaughter's husband) was born in 1956 in Cleveland, Ohio, USA.
James Vencent Boyd married Brenda Sue Sobo²⁰. They had two children:
Caitlin Arlena Boyd¹ in 1992
Jason Alexander Boyd² in 1994
This family is shown as family tree 1.
22. RANDY EUGENE SOBO (James's four-times-great-grandson) was born on 7 July 1959 in Medford, Jackson, Organ, USA to Cornell Alexander Sobo, Jr.¹²⁷ and Charlotte Arlene Kennaday¹²⁶, as shown in family tree 9.
23. KIM EILEEN JOHNSON (James's four-times-great-grandson's wife).
Randy Eugene Sobo²² married Kim Eileen Johnson. They had four children:
Justin Kyle Sobo³ in 1982
Julie Erin Sobo⁴ in 1985
Travis Andrew Sobo⁵ in 1987
Tyler Jamison Sobo⁶ in 1987
This family is shown as family tree 2.
24. TERESA LYNN SOBO (James's four-times-great-granddaughter) was born on 19 August 1960 in Medford, Jackson, Organ, USA to Cornell Alexander Sobo, Jr.¹²⁷ and Charlotte Arlene Kennaday¹²⁶, as shown in family tree 9.
25. TOM CLARIDGE (James's four-times-great-granddaughter's husband).
Tom Claridge married Teresa Lynn Sobo²⁴.
26. KARLA LYNN KENNADAY (James's four-times-great-granddaughter) was born on 8 July 1961 in Vallejo, Napa, California, USA to Thomas Eugene Kennaday¹²⁸ and Janice Benson¹²⁹, as shown in family tree 10.
27. KATHY KAY KENNADAY (James's four-times-great-granddaughter) was born in 1962 in Vallejo, Napa, California, USA to Thomas Eugene Kennaday¹²⁸ and Janice Benson¹²⁹, as shown in family tree 10.
28. LORI ANN GEPPERT (James's four-times-great-granddaughter) was born on 18 February 1960 in Portland, Washington, Organ, USA to August Henry Geppert¹³¹ and Patty Ray Kennaday¹³⁰, as shown in family tree 11.
29. DAVID LESTER WHITE (James's four-times-great-granddaughter's husband).
David Lester White married Lori Ann Geppert²⁸.
30. JUDY ARLENE GEPPERT (James's four-times-great-granddaughter) was born in 1962 in Portland, Washington, Organ, USA to August Henry Geppert¹³¹ and Patty Ray Kennaday¹³⁰, as shown in family tree 11.
31. DAIRLD GEAN WURTZ (James's four-times-great-granddaughter's husband).
Dairld Gean Wurtz married Judy Arlene Geppert³⁰.
32. TOMMY DUANE GEPPERT (James's four-times-great-grandson) was born in 1964 in Portland, Washington, Organ, USA to August Henry Geppert¹³¹ and Patty Ray Kennaday¹³⁰, as shown in family tree 11.
33. TODD KENNADAY (James's four-times-great-grandson) was born on 5 May 1960 in Oregon to Jack Wayne Kennaday¹³⁶ and Carol Lee Brant¹³⁷, as shown in family tree 14.
34. JOYCE ELLEN JORGENSEN (James's four-times-great-grandson's wife) was born in 1962 in Phoenix, Orange, Arizona, USA.
Todd Kennaday³³ married Joyce Ellen Jorgensen. They had two children:
Adam Malaki Kennaday⁷ in 1987
Aaron Forest Kennaday⁸ in 1990
This family is shown as family tree 3.
35. DARREN KENNADAY (James's four-times-great-grandson) was born on 19 February 1964 to Jack Wayne Kennaday¹³⁶ and Carol Lee Brant¹³⁷, as shown in family tree 14.
36. KELLY MICHELE KENNADAY (James's four-times-great-granddaughter) was born on 9 July 1965 to Gary Forrest Kennaday¹³⁸ and Alice Thompson¹⁴⁰, as shown in family tree 15.
37. JEFFREY MICHAEL KENNADAY (James's four-times-great-grandson) was born on 26 September 1967 to Michael Joseph Kennaday¹⁴¹ and Carolyn Williams¹⁴², as shown in family tree 16.

38. DELERA KAY LOTT (James's four-times-great-granddaughter) was born on 8 November 1958 to Jimmy Ray Lott¹⁴³ and Ellen Dollar Hyde¹⁴⁴, as shown in family tree 17.
39. KATHY ANN LOTT (James's four-times-great-granddaughter) was born on 12 December 1960 to Jimmy Ray Lott¹⁴³ and Ellen Dollar Hyde¹⁴⁴, as shown in family tree 17.
40. MANNETT MARIE LOTT (James's four-times-great-granddaughter) was born on 4 June 1964 to Jimmy Ray Lott¹⁴³ and Ellen Dollar Hyde¹⁴⁴, as shown in family tree 17.
41. ROXY ANN LOTT (James's four-times-great-granddaughter) was born on 24 January 1966 to Jimmy Ray Lott¹⁴³ and Ellen Dollar Hyde¹⁴⁴, as shown in family tree 17.
42. LEE ANN MARIE LOTT (James's four-times-great-granddaughter) was born in August 1960 to Al Blunt¹⁴⁶ and Rosa Lee Lott¹⁴⁵, as shown in family tree 18.
43. CALVIN E TERETT LOTT (James's four-times-great-grandson) was born in July 1962 to Al Blunt¹⁴⁶ and Rosa Lee Lott¹⁴⁵, as shown in family tree 18.
44. KATY SUE BLUNT (James's four-times-great-granddaughter) was born on 21 June 1965 to Al Blunt¹⁴⁶ and Rosa Lee Lott¹⁴⁵, as shown in family tree 18.
45. ED BLUNT (James's four-times-great-grandson) was born to Al Blunt¹⁴⁶ and Rosa Lee Lott¹⁴⁵, as shown in family tree 18.
46. JOHN FRANK LOTT (James's four-times-great-grandson) was born on 23 September 1960 to Calvin Jay Lott¹⁴⁷ and Jo Ann Sturgess¹⁴⁸, as shown in family tree 19.
47. DIANA LOTT (James's four-times-great-granddaughter) was born on 13 September 1963 to Calvin Jay Lott¹⁴⁷ and Jo Ann Sturgess¹⁴⁸, as shown in family tree 19.
48. MICHELE LOTT (James's four-times-great-granddaughter) was born in June 1967 to Calvin Jay Lott¹⁴⁷ and Jo Ann Sturgess¹⁴⁸, as shown in family tree 19.
49. LISA SLOANE (James's four-times-great-granddaughter) was born to Mr. Sloane¹⁵⁰ and Mable Bea Lott¹⁴⁹, as shown in family tree 20.
50. LARRY SLOANE (James's four-times-great-grandson) was born to Mr. Sloane¹⁵⁰ and Mable Bea Lott¹⁴⁹, as shown in family tree 20.
51. MICHAEL RAMSEY (ADOPTED) (James's four-times-great-grandson) was born to Earl Efton (Butch) Ramsey¹³² and Rosa L Hubbard¹³³, as shown in family tree 12.
52. LISA JUNE KELLEY (James's four-times-great-granddaughter) was born on 18 December 1963 in Carlisle, Kentucky, USA to Ronald David Kelley, Sr.¹⁵⁴ and Betty Carol Fitzpatrick¹⁵⁵, as shown in family tree 21. (Lisa married twice. She was married to Cristian Hunnicutt⁵³ and James Mickel Asbury⁵⁴.)
53. CRISTIAN HUNNICUTT (James's four-times-great-granddaughter's husband) was born in Tennessee. Cristian Hunnicutt married Lisa June Kelley⁵², aged 18, on 13 February 1982 in Indianapolis, Indiana, USA. They had one son:
 Christian David Hunnicutt⁹ in 1983
 This family is shown as family tree 4.
54. JAMES MICKEL ASBURY (James's four-times-great-granddaughter's husband) was born in Cynthiana, Kentucky, USA. James Mickel Asbury married Lisa June Kelley⁵², aged 26, on 26 May 1990 in Cynthiana, Scott, Kentucky, USA. They had two children:
 James Mathew Asbury¹⁰ in 1991
 Liam Joseph Asbury¹¹
 This family is shown as family tree 5.
55. MELINDA (ADOPTED) RAMSEY (James's four-times-great-granddaughter) was born to Earl Efton (Butch) Ramsey¹³² and Rosa L Hubbard¹³³, as shown in family tree 12.
56. ANNA CAROL KELLEY (James's four-times-great-granddaughter) was born on 27 November 1964 to Ronald David Kelley, Sr.¹⁵⁴ and Betty Carol Fitzpatrick¹⁵⁵, as shown in family tree 21.
57. GREGORY WERT (James's four-times-great-granddaughter's husband).

Gregory Wert married Anna Carol Kelley⁵⁶, aged 18, on 28 May 1983 in Indianapolis, Indiana, USA.

58. RONALD DAVID KELLEY, JR. (James's four-times-great-grandson) was born on 9 June 1966 in Lexington, Kentucky, USA to Ronald David Kelley, Sr.¹⁵⁴ and Betty Carol Fitzpatrick¹⁵⁵, as shown in family tree 21. Ronald died on 15 September 1997, aged 31, in Indianapolis, Marion, Indiana, USA. He was buried in Washinton Park Cemetery, Indianapolis, Indiana.
59. SHERRIE (LIKE A DAUGHTER) JONES (James's four-times-great-granddaughter) was born to Ronald David Kelley, Sr.¹⁵⁴ and Betty Carol Fitzpatrick¹⁵⁵, as shown in family tree 21.
60. MARK MEYER (James's four-times-great-granddaughter's husband).
Mark Meyer married Sherrie (Like a Daughter) Jones⁵⁹ in November 1987. They had two children:
Kayla Meyer¹²
Cody Meyer¹³
This family is shown as family tree 6.
61. BOB HAYES (James's four-times-great-grandson) was born to Bob Hayes¹³⁵ and Afton Ernstine (Marier) Ramsey¹³⁴, as shown in family tree 13.
62. ANITA CAROL CURTIS (James's four-times-great-granddaughter) was born on 9 April 1964 in ICarlisle, Nichlos, Kentucky, USA to Norman Perry Curtis¹⁵⁷ and Carolyn June Kelley¹⁵⁶, as shown in family tree 22. (Anita married three times. She was married to Tim Lett⁶³, George Stamps⁶⁴ and Mike Phelps⁶⁵.)
63. TIM LETT (James's four-times-great-granddaughter's husband).
Tim Lett married Anita Carol Curtis⁶². They had three children:
Tim Lett¹⁴
Sara Lett¹⁵
Cory Lett¹⁶
This family is shown as family tree 7.
64. GEORGE STAMPS (James's four-times-great-granddaughter's husband).
George Stamps married Anita Carol Curtis⁶².
65. MIKE PHELPS (James's four-times-great-granddaughter's husband).
Mike Phelps married Anita Carol Curtis⁶², aged 20, on 27 August 1984.
66. LINDA HAYES (James's four-times-great-granddaughter) was born in 1957 to Bob Hayes¹³⁵ and Afton Ernstine (Marier) Ramsey¹³⁴, as shown in family tree 13.
67. NORMAN PERRY CURTIS, JR. (James's four-times-great-grandson) was born on 28 August 1966 in Indianapolis, Marion, Indiana, USA to Norman Perry Curtis¹⁵⁷ and Carolyn June Kelley¹⁵⁶, as shown in family tree 22.
68. BARBARA UNKNOWN (James's four-times-great-grandson's wife).
Norman Perry Curtis, Jr.⁶⁷ married Barbara Unknown.
69. MELONY JO CURTIS (James's four-times-great-granddaughter) was born on 14 January 1970 in Indianapolis, Marion, Indiana, USA to Norman Perry Curtis¹⁵⁷ and Carolyn June Kelley¹⁵⁶, as shown in family tree 22. Melony died on 8 December 1970 as an infant, in Indianapolis, Marion, Indiana, USA. She was buried in Carlisle, Cemetery, Carlisle, Kentucky.
70. TOBY HAYES (James's four-times-great-grandson) was born in 1958 to Bob Hayes¹³⁵ and Afton Ernstine (Marier) Ramsey¹³⁴, as shown in family tree 13.
71. KAREN HAYES (James's four-times-great-granddaughter) was born in 1962 to Bob Hayes¹³⁵ and Afton Ernstine (Marier) Ramsey¹³⁴, as shown in family tree 13.
72. DAVID EARL CURTIS (James's four-times-great-grandson) was born on 17 April 1973 in Indianapolis, Marion, Indiana, USA to Norman Perry Curtis¹⁵⁷ and Carolyn June Kelley¹⁵⁶, as shown in family tree 22.
73. TONI BENNER (James's four-times-great-grandson's wife).
David Earl Curtis⁷², aged 23, married Toni Benner on 7 July 1996. They had three children:
Mercedes Curtis¹⁷ in 1994
Savanna June Curtis¹⁸ in 1995
Ivie Ski Curtis¹⁹ in 1996
This family is shown as family tree 8.
74. NICHOLAS ISAIAH KENNADAY (James's four-times-great-grandson) was born in 1978 in Roseburg, Douglas, Oregon, USA to David Debernardi Kennaday¹⁶⁷ and Paula Jo Smith¹⁶⁸, as shown in family tree 25.

75. ELIZABETH ALTA OLIVIA KENNADAY (James's four-times-great-granddaughter) was born in 1980 in Roseburg, Douglas, Oregon, USA to David Debernardi Kennaday¹⁶⁷ and Paula Jo Smith¹⁶⁸, as shown in family tree 25.
76. CRISTINA DIANNE KENNADAY (James's four-times-great-granddaughter) was born in 1982 in Roseburg, Douglas, Oregon, USA to David Debernardi Kennaday¹⁶⁷ and Paula Jo Smith¹⁶⁸, as shown in family tree 25.
77. JOSHUA JOLIN KENNADAY (James's four-times-great-grandson) was born in 1982 in Glide, Douglas, Oregon, USA to Steven Scott Kennaday¹⁶⁹ and Catherine Susan Lavelle¹⁷⁰, as shown in family tree 26.
78. MALLORY KENNADAY (James's four-times-great-granddaughter) was born to Steven Scott Kennaday¹⁶⁹ and Danielle Reed¹⁷¹, as shown in family tree 27.
79. REED KENNADAY (James's four-times-great-grandson) was born to Steven Scott Kennaday¹⁶⁹ and Danielle Reed¹⁷¹, as shown in family tree 27.
80. PATRICIA LEIGH KENNADAY (James's four-times-great-granddaughter) was born in 1979 in San Diego, San Diego, California, USA to Fredrick Frank Kennaday¹⁷² and Brigid Ann Young¹⁷³, as shown in family tree 28.
81. ANTHONY JOSEPH KENNADAY (James's four-times-great-grandson) was born in 1981 in Roseburg, Douglas, Oregon, USA to Fredrick Frank Kennaday¹⁷² and Brigid Ann Young¹⁷³, as shown in family tree 28.
82. GORDON SCOTT (SCOTTY) JOHNSON (James's four-times-great-grandson) was born on 10 August 1962 to Gordon Johnson¹⁶² and Sherry Jean Marier¹⁶⁰, as shown in family tree 23.
83. STANLEY (STAN) JOHNSON (James's four-times-great-grandson) was born on 14 June 1965 to Gordon Johnson¹⁶² and Sherry Jean Marier¹⁶⁰, as shown in family tree 23.
84. MIKE ALLEN FORRESTER, JR. (James's four-times-great-grandson) was born on 22 January 1966 to Micheal A Forrester¹⁶⁴ and Jane Marie Marier¹⁶³, as shown in family tree 24.
85. TOMMY JAMES FORRESTER (James's four-times-great-grandson) was born on 4 May 1968 to Micheal A Forrester¹⁶⁴ and Jane Marie Marier¹⁶³, as shown in family tree 24.
86. JAMIE FORRESTER (James's four-times-great-granddaughter) was born to Micheal A Forrester¹⁶⁴ and Jane Marie Marier¹⁶³, as shown in family tree 24.
87. ROBBYN CHERTER WHITMAN (James's four-times-great-grandson) was born in 1959 to Nelson Chester Whitman¹⁷⁴ and Cecelia Kay Pendergrass¹⁷⁵, as shown in family tree 29.
88. PERI ANN WHITMAN (James's four-times-great-granddaughter) was born in 1960 to Nelson Chester Whitman¹⁷⁴ and Cecelia Kay Pendergrass¹⁷⁵, as shown in family tree 29.
89. MARCUS PINE WHITMAN (James's four-times-great-grandson) was born in 1962 to Nelson Chester Whitman¹⁷⁴ and Claudette Irene Corlett¹⁷⁶, as shown in family tree 30.
90. MICHEAL GERALD STURM WHITMAN (James's four-times-great-grandson) was born in 1968 to Boyd David Whitman¹⁷⁸ and Carolyn M Thompson¹⁷⁹, as shown in family tree 31.
91. PATRICK KEITH WHITMAN (James's four-times-great-grandson) was born in 1969 to Boyd David Whitman¹⁷⁸ and Carolyn M Thompson¹⁷⁹, as shown in family tree 31.
92. NATHANIELLE REBECCA WHITMAN (James's four-times-great-granddaughter) was born in 1973 to Boyd David Whitman¹⁷⁸ and Carolyn M Thompson¹⁷⁹, as shown in family tree 31.
93. GRANT DOUGLAS WHITMAN (James's four-times-great-grandson) was born in 1967 to Richard Ward Whitman¹⁸⁰ and Robin Knipp Jouett¹⁸¹, as shown in family tree 32.
94. GAIL ROBIN WHITMAN (James's four-times-great-granddaughter) was born in 1968 to Richard Ward Whitman¹⁸⁰ and Robin Knipp Jouett¹⁸¹, as shown in family tree 32.
95. TORI DAWN BARTLETT (James's four-times-great-granddaughter) was born in 1963 to Joseph Grant Bartlett¹⁸³ and Charlotte Louise Whitman¹⁸², as shown in family tree 33.

96. TRAVIS DARRYL BARTLETT (James's four-times-great-grandson) was born in 1969 to Joseph Grant Bartlett¹⁸³ and Charlotte Louise Whitman¹⁸², as shown in family tree 33.
97. TREVOR DAVID BARTLETT (James's four-times-great-grandson) was born in 1974 to Joseph Grant Bartlett¹⁸³ and Charlotte Louise Whitman¹⁸², as shown in family tree 33.
98. BRADLY TOMMY THOMPSON (James's four-times-great-grandson) was born in 1966 to Tommy M Thompson¹⁸⁵ and Marcella Ann Whitman¹⁸⁴, as shown in family tree 34.
99. FRED WINTON SMITH (James's four-times-great-grandson) was born in 1967 to Fred Winton Smith¹⁸⁷ and Phillis Lana Whitman¹⁸⁶, as shown in family tree 35.
100. COLLIN WADE WHITMAN (James's four-times-great-grandson) was born in 1969 to Fred Winton Smith¹⁸⁷ and Phillis Lana Whitman¹⁸⁶, as shown in family tree 35.
101. STUART BRANSON SELF (James's four-times-great-grandson) was born in 1974 to Stanley Howard Self¹⁸⁹ and Laurel Alice Whitman¹⁸⁸, as shown in family tree 36.
102. IAN MATHEW SELF (James's four-times-great-grandson) was born in 1975 to Stanley Howard Self¹⁸⁹ and Laurel Alice Whitman¹⁸⁸, as shown in family tree 36.
103. ASHLEY CHESTER SELF (James's four-times-great-grandson) was born in 1977 to Stanley Howard Self¹⁸⁹ and Laurel Alice Whitman¹⁸⁸, as shown in family tree 36.
104. THOMAS ELLIOTT PAGE (James's four-times-great-grandson) was born in 1971 in Ogden, Weber, Utah, USA to Ronald Otis Page²²⁷ and Linda Ann Cairns²²⁶, as shown in family tree 37.
105. JOHNATHAN JACK PAGE (James's four-times-great-grandson) was born in 1973 in Rawlins, Carbon, Wyoming, USA to Ronald Otis Page²²⁷ and Linda Ann Cairns²²⁶, as shown in family tree 37.
106. DONALD GRANT PAGE (James's four-times-great-grandson) was born in 1975 in Rawlins, Carbon, Wyoming, USA to Ronald Otis Page²²⁷ and Linda Ann Cairns²²⁶, as shown in family tree 37.
107. TRIANA MARIE CAMPBELL (James's four-times-great-granddaughter) was born in 1978 in Salt Lake City, Salt Lake, Utah, USA to Craig Campbell²²⁹ and Christine Marie Cairns²²⁸, as shown in family tree 38.
108. HOLLY ANN CAMPBELL (James's four-times-great-granddaughter) was born in 1980 in Salt Lake City, Salt Lake, Utah, USA to Craig Campbell²²⁹ and Christine Marie Cairns²²⁸, as shown in family tree 38.
109. ERIC RAYMOND CAMPBELL (James's four-times-great-grandson) was born in 1985 in Salt Lake City, Salt Lake, Utah, USA to Craig Campbell²²⁹ and Christine Marie Cairns²²⁸, as shown in family tree 38.
110. RACHEL ELIZABETH CAIRNS (James's four-times-great-granddaughter) was born in 1979 to Jack Lavoy Cairns, Jr.²³⁰ and Rebecca Cassler²³¹, as shown in family tree 39.
111. MARY MELISSA CAIRNS (James's four-times-great-granddaughter) was born in 1983 to Jack Lavoy Cairns, Jr.²³⁰ and Rebecca Cassler²³¹, as shown in family tree 39.
112. JEREMY ALAN HANSEN (James's four-times-great-grandson) was born in 1975 in Craig, Moffat, Colorado, USA to Alan Hansen²³³ and Elizabeth Kay Cairns²³², as shown in family tree 40.
113. AARON WAYNE HANSEN (James's four-times-great-grandson) was born in 1976 in Idaho Falls, Bonneville, Idaho, USA to Alan Hansen²³³ and Elizabeth Kay Cairns²³², as shown in family tree 40.
114. MICHAEL BRENT HANSEN (James's four-times-great-grandson) was born in 1979 in Idaho Falls, Bonneville, Idaho, USA to Alan Hansen²³³ and Elizabeth Kay Cairns²³², as shown in family tree 40.
115. AMY NICOLE HANSEN (James's four-times-great-granddaughter) was born in 1981 in Idaho Falls, Bonneville, Idaho, USA to Alan Hansen²³³ and Elizabeth Kay Cairns²³², as shown in family tree 40.
116. JACOB KARL HANSEN (James's four-times-great-grandson) was born in 1983 in Idaho Falls, Bonneville, Idaho, USA to Alan Hansen²³³ and Elizabeth Kay Cairns²³², as shown in family tree 40.

117. DORCI KAE CAIRNS (James's four-times-great-granddaughter) was born in 1983 in Idaho Falls, Bonneville, Idaho, USA to William Wayne Cairns²³⁴ and Kae Porter²³⁵, as shown in family tree 41.
118. JACE WILLIAM CAIRNS (James's four-times-great-grandson) was born in 1988 in Idaho Falls, Bonneville, Idaho, USA to William Wayne Cairns²³⁴ and Kae Porter²³⁵, as shown in family tree 41.
119. BRINDI MICHELLE CAIRNS (James's four-times-great-granddaughter) was born in 1991 in Idaho Falls, Bonneville, Idaho, USA to William Wayne Cairns²³⁴ and Kae Porter²³⁵, as shown in family tree 41.
120. TIFFANY ANNE COOPER (James's four-times-great-granddaughter) was born in 1977 in Logan, Cache, Utah, USA to John Ellery Cooper²³⁷ and Rebecca Gay Cairns²³⁶, as shown in family tree 42.
121. STEVE HIX (James's four-times-great-granddaughter's husband) was born in 1977.
Steve Hix married Tiffany Anne Cooper¹²⁰.
122. HILLARY RANEE COOPER (James's four-times-great-granddaughter) was born in 1978 in Logan, Cache, Utah, USA to John Ellery Cooper²³⁷ and Rebecca Gay Cairns²³⁶, as shown in family tree 42.
123. KREETA ANN JEBENS (James's four-times-great-granddaughter) was born in 1975 in Rawlins, Carbon, Wyoming, USA to Carlie Jebens²⁴¹ and Phyllis Ann Wilson²⁴⁰, as shown in family tree 43.
124. KOREY KAY JEBENS (James's four-times-great-granddaughter) was born in 1977 in Rawlins, Carbon, Wyoming, USA to Carlie Jebens²⁴¹ and Phyllis Ann Wilson²⁴⁰, as shown in family tree 43.
125. CARLIE NORMAN JEBENS (James's four-times-great-grandson) was born in 1979 in Rawlins, Carbon, Wyoming, USA to Carlie Jebens²⁴¹ and Phyllis Ann Wilson²⁴⁰, as shown in family tree 43. Carlie died in 1995, aged about 16.

Generation of Great-Great-Great-Grandchildren

126. CHARLOTTE ARLENE KENNADAY (James's great-great-great-granddaughter) was born on 28 October 1933 to Thomas Earl Kennaday²⁵² and Gladys Eleanor Ream²⁵³, as shown in family tree 44.
127. CORNELL ALEXANDER SOBO, JR. (James's great-great-great-granddaughter's husband) was born on 28 October 1933. Cornell Alexander Sobo, Jr. married Charlotte Arlene Kennaday¹²⁶. They had three children:
Brenda Sue Sobo²⁰ in 1958
Randy Eugene Sobo²² in 1959
Teresa Lynn Sobo²⁴ in 1960
This family is shown as family tree 9.
128. THOMAS EUGENE KENNADAY (James's great-great-great-grandson) was born on 14 August 1935 in Saratoga, Carbon, Wyoming, USA to Thomas Earl Kennaday²⁵² and Gladys Eleanor Ream²⁵³, as shown in family tree 44.
129. JANICE BENSON (James's great-great-great-grandson's wife).
Thomas Eugene Kennaday¹²⁸, aged about 24, married Janice Benson in 1960 in Antonio, Texas. They had two children:
Karla Lynn Kennaday²⁶ in 1961
Kathy Kay Kennaday²⁷ in 1962
This family is shown as family tree 10.
130. PATTY RAY KENNADAY (James's great-great-great-granddaughter) was born on 3 August 1937 in Rawlins, Carbon, Wyoming, USA to Thomas Earl Kennaday²⁵² and Gladys Eleanor Ream²⁵³, as shown in family tree 44.
131. AUGUST HENRY GEPPERT (James's great-great-great-granddaughter's husband) was born in 1937 in Portland, Washington, Oregon, USA.
August Henry Geppert, aged about 21, married Patty Ray Kennaday¹³⁰, aged 20, on 26 July 1958. They had three children:
Lori Ann Geppert²⁸ in 1960
Judy Arlene Geppert³⁰ in 1962
Tommy Duane Geppert³² in 1964
This family is shown as family tree 11.
132. EARL EFTON (BUTCH) RAMSEY (James's great-great-great-grandson) was born on 24 April 1937 to Earl N Ramsey²⁵⁶ and Florence Mae Kennaday²⁵⁴, as shown in family tree 45.
133. ROSA L HUBBARD (James's great-great-great-grandson's wife) was born on 26 September 1937.
Earl Efton (Butch) Ramsey¹³² married Rosa L Hubbard. They had two children:

Michale Ramsey (adopted)⁵¹
 Melinda (adopted) Ramsey⁵⁵
This family is shown as family tree 12.

134. AFTON ERNSTINE (MARIER) RAMSEY (James's great-great-great-granddaughter) was born to Earl N Ramsey²⁵⁶ and Florence Mae Kennaday²⁵⁴, as shown in family tree 45.

135. BOB HAYES (James's great-great-great-granddaughter's husband).

Bob Hayes married Afton Ernstine (Marier) Ramsey¹³⁴. They had four children:

Bob Hayes⁶¹

Linda Hayes⁶⁶ in 1957

Toby Hayes⁷⁰ in 1958

Karen Hayes⁷¹ in 1962

This family is shown as family tree 13.

136. JACK WAYNE KENNADAY (James's great-great-great-grandson) was born on 15 December 1939 to Ellen (Dude) Stockwell²⁵⁸ and Forest Jack Kennaday²⁵⁷, as shown in family tree 46.

137. CAROL LEE BRANT (James's great-great-great-grandson's wife).

Jack Wayne Kennaday¹³⁶ married Carol Lee Brant. They had two children:

Todd Kennaday³³ in 1960

Darren Kennaday³⁵ in 1964

This family is shown as family tree 14.

138. GARY FORREST KENNADAY (James's great-great-great-grandson) was born on 7 February 1942 to Ellen (Dude) Stockwell²⁵⁸ and Forest Jack Kennaday²⁵⁷, as shown in family tree 46.

(Gary married twice. He was married to Vicki Compton¹³⁹ and Alice Thompson¹⁴⁰.)

139. VICKI COMPTON (James's great-great-great-grandson's wife).

Gary Forrest Kennaday¹³⁸ married Vicki Compton.

140. ALICE THOMPSON (James's great-great-great-grandson's wife).

Gary Forrest Kennaday¹³⁸ married Alice Thompson. They had one daughter:

Kelly Michele Kennaday³⁶ in 1965

This family is shown as family tree 15.

141. MICHAEL JOSEPH KENNADAY (James's great-great-great-grandson) was born to Ellen (Dude) Stockwell²⁵⁸ and Forest Jack Kennaday²⁵⁷, as shown in family tree 46.

142. CAROLYN WILLIAMS (James's great-great-great-grandson's wife).

Michael Joseph Kennaday¹⁴¹ married Carolyn Williams. They had one son:

Jeffrey Michael Kennaday³⁷ in 1967

This family is shown as family tree 16.

143. JIMMY RAY LOTT (James's great-great-great-grandson) was born on 22 March 1940 to Calvin Lott²⁶⁰ and Rose Marie Kennaday²⁵⁹, as shown in family tree 47.

144. ELLEN DOLLAR HYDE (James's great-great-great-grandson's wife).

Jimmy Ray Lott¹⁴³ married Ellen Dollar Hyde. They had four children:

Delera Kay Lott³⁸ in 1958

Kathy Ann Lott³⁹ in 1960

MAnnett Marie Lott⁴⁰ in 1964

Roxy Ann Lott⁴¹ in 1966

This family is shown as family tree 17.

145. ROSA LEE LOTT (James's great-great-great-granddaughter) was born to Calvin Lott²⁶⁰ and Rose Marie Kennaday²⁵⁹, as shown in family tree 47.

146. AL BLUNT (James's great-great-great-granddaughter's husband).

Al Blunt married Rosa Lee Lott¹⁴⁵. They had four children:

Lee Ann Marie Lott⁴² in 1960

Calvin E Terett Lott⁴³ in 1962

Katy Sue Blunt⁴⁴ in 1965

Ed Blunt⁴⁵

This family is shown as family tree 18.

147. CALVIN JAY LOTT (James's great-great-great-grandson) was born to Calvin Lott²⁶⁰ and Rose Marie Kennaday²⁵⁹, as shown in family tree 47.

148. JO ANN STURGESS (James's great-great-great-grandson's wife).

Calvin Jay Lott¹⁴⁷ married Jo Ann Sturgess. They had three children:

John Frank Lott⁴⁶ in 1960

Diana Lott⁴⁷ in 1963

Michele Lott⁴⁸ in 1967

This family is shown as family tree 19.

149. MABLE BEA LOTT (James's great-great-great-granddaughter) was born to Calvin Lott²⁶⁰ and Rose Marie Kennaday²⁵⁹, as shown in family tree 47.

(Mable married twice. She was married to Mr. Sloane¹⁵⁰ and Lawrence P Patchins¹⁵¹.)

150. MR. SLOANE (James's great-great-great-granddaughter's husband).

Mr. Sloane married Mable Bea Lott¹⁴⁹. They had two children:

Lisa Sloane⁴⁹

Larry Sloane⁵⁰

This family is shown as family tree 20.

151. LAWRENCE P PATCHINS (James's great-great-great-granddaughter's husband).

Lawrence P Patchins married Mable Bea Lott¹⁴⁹.

152. JOHN LOTT (James's great-great-great-grandson) was born to Calvin Lott²⁶⁰ and Rose Marie Kennaday²⁵⁹, as shown in family tree 47.

153. RANDY EUGENE LOTT (James's great-great-great-grandson) was born on 29 December 1962 to Calvin Lott²⁶⁰ and Rose Marie Kennaday²⁵⁹, as shown in family tree 47.

154. RONALD DAVID KELLEY, SR. (James's great-great-great-grandson) was born on 10 September 1943 in Pueblo, Colorado, USA to John David Kelley²⁶² and Iva June Kennaday²⁶¹, as shown in family tree 48.

Note: Ron and Betty lived in a trailer on Myers Station Road in Carlisle, Kentucky after they were married. In November of 1963 they moved into a house in Myers Station living there a short time before moving to a house in Carlisle in 1964. In September of 1964 we moved to George town to be closer to where Ron took a Job at Stiohn Products. After working there about Ron enroled into a Government Sponsored program as a Tool and Die maker. Where He finished his apprenticeship in 1969. Ron and Betty had their house to burn in the summer of 1969 while visiting Betty's sister Sandy Thompson in Tampa Florida.

Ron & Betty Took in foster kid during the 80's.

One of the foster kids, Steven Wayn Banks 12-22-1980 - 8-10-1981 another was Sherie Jones in 2-1982.

155. BETTY CAROL FITZPATRICK (James's great-great-great-grandson's wife) was born on 14 April 1947 in Paris, Bourbon, Kentucky, USA to Edward S (Pete) Fitzpatrick³⁷² and Virginia Ruth Gulett³⁷⁴.

[See also: Indirectly related via Betty Carol Fitzpatrick]

Ronald David Kelley, Sr.¹⁵⁴, aged 19, married Betty Carol Fitzpatrick, aged 15, on 6 April 1963 in Carlisle, Kentucky, USA. They had four children:

Lisa June Kelley⁵² in 1963

Anna Carol Kelley⁵⁶ in 1964

Ronald David Kelley, Jr.⁵⁸ in 1966

Sherrie (Like a Daughter) Jones⁵⁹

This family is shown as family tree 21.

156. CAROLYN JUNE KELLEY (James's great-great-great-granddaughter) was born on 8 February 1945 in Carlisle, Kentucky, USA to John David Kelley²⁶² and Iva June Kennaday²⁶¹, as shown in family tree 48. Carolyn died on 25 July 1993, aged 48. She was buried in Creamation: Ashes on grave of Melony Jo Curtis Daughter.

157. NORMAN PERRY CURTIS (James's great-great-great-granddaughter's husband) was born in 1940.

Norman Perry Curtis, aged about 22, married Carolyn June Kelley¹⁵⁶, aged 17, on 12 January 1963 in Carlisle, Kentucky, USA. They had four children:

Anita Carol Curtis⁶² in 1964

Norman Perry Curtis, Jr.⁶⁷ in 1966

Melony Jo Curtis⁶⁹ in 1970

David Earl Curtis⁷² in 1973

This family is shown as family tree 22.

158. STANLEY JOHNSON (James's great-great-great-grandson) was born to Gordon Johnson²⁶⁴ and Bonnie Jean Kennaday²⁶³, as shown in family tree 49.

159. SCOTT JOHNSON (James's great-great-great-grandson) was born to Gordon Johnson²⁶⁴ and Bonnie Jean Kennaday²⁶³, as shown in family tree 49.

160. SHERRY JEAN MARIER (James's great-great-great-granddaughter) was born on 22 November 1942 to James Martin Marier²⁶⁵ and Bonnie Jean Kennaday²⁶³, as shown in family tree 50.
(Sherry married twice. She was married to Jim Schoenwald¹⁶¹ and Gordon Johnson¹⁶².)
161. JIM SCHOENWALD (James's great-great-great-granddaughter's husband).
Jim Schoenwald married Sherry Jean Marier¹⁶⁰.
162. GORDON JOHNSON (James's great-great-great-granddaughter's husband).
Gordon Johnson married Sherry Jean Marier¹⁶⁰. They had two children:
Gordon Scott (Scotty) Johnson⁸² in 1962
Stanley (Stan) Johnson⁸³ in 1965
This family is shown as family tree 23.
163. JANE MARIE MARIER (James's great-great-great-granddaughter) was born on 4 February 1945 to James Martin Marier²⁶⁵ and Bonnie Jean Kennaday²⁶³, as shown in family tree 50.
164. MICHEAL A FORRESTER (James's great-great-great-granddaughter's husband).
Micheal A Forrester married Jane Marie Marier¹⁶³. They had three children:
Mike Allen Forrester, Jr.⁸⁴ in 1966
Tommy James Forrester⁸⁵ in 1968
Jamie Forrester⁸⁶
This family is shown as family tree 24.
165. GARY JO KENNADAY (James's great-great-great-grandson) was born on 4 March 1946 in Roseburg, Douglas, Oregon, USA to Lincoln Frank Kennaday²⁶⁶ and Joan Olivia Debernardi²⁶⁷, as shown in family tree 51.
166. RITA DIANNE RHOADS (James's great-great-great-grandson's wife) was born in 1951.
Gary Jo Kennaday¹⁶⁵ married Rita Dianne Rhoads.
167. DAVID DEBERNARDI KENNADAY (James's great-great-great-grandson) was born on 8 January 1949 in Roseburg, Douglas, Oregon, USA to Lincoln Frank Kennaday²⁶⁶ and Joan Olivia Debernardi²⁶⁷, as shown in family tree 51.
168. PAULA JO SMITH (James's great-great-great-grandson's wife) was born in 1953 in Roseburg, Douglas, Oregon, USA.
David Debernardi Kennaday¹⁶⁷ married Paula Jo Smith. They had three children:
Nicholas Isaiah Kennaday⁷⁴ in 1978
Elizabeth Alta Olivia Kennaday⁷⁵ in 1980
Cristina Dianne Kennaday⁷⁶ in 1982
This family is shown as family tree 25.
169. STEVEN SCOTT KENNADAY (James's great-great-great-grandson) was born on 5 March 1956 in Roseburg, Douglas, Oregon, USA to Lincoln Frank Kennaday²⁶⁶ and Joan Olivia Debernardi²⁶⁷, as shown in family tree 51.
(Steven married twice. He was married to Catherine Susan Lavelle¹⁷⁰ and Danielle Reed¹⁷¹.)
170. CATHERINE SUSAN LAVELLE (James's great-great-great-grandson's wife) was born in 1956 in Van Nuys, California, USA.
Steven Scott Kennaday¹⁶⁹ married Catherine Susan Lavelle. They had one son:
Joshua Jolin Kennaday⁷⁷ in 1982
This family is shown as family tree 26.
171. DANIELLE REED (James's great-great-great-grandson's wife).
Steven Scott Kennaday¹⁶⁹ married Danielle Reed. They had two children:
Mallory Kennaday⁷⁸
Reed Kennaday⁷⁹
This family is shown as family tree 27.
172. FREDRICK FRANK KENNADAY (James's great-great-great-grandson) was born on 5 May 1957 in Roseburg, Douglas, Oregon, USA to Lincoln Frank Kennaday²⁶⁶ and Joan Olivia Debernardi²⁶⁷, as shown in family tree 51.
173. BRIGID ANN YOUNG (James's great-great-great-grandson's wife) was born in 1956 in Burbank, Los Angeles, California, USA.
Fredrick Frank Kennaday¹⁷² married Brigid Ann Young. They had two children:
Patricia Leigh Kennaday⁸⁰ in 1979
Anthony Joseph Kennaday⁸¹ in 1981
This family is shown as family tree 28.
174. NELSON CHESTER WHITMAN (James's great-great-great-grandson) was born in 1939 in BigPiney, Sublette, Wyoming, USA to Bruce Douglas Whitman²⁷⁶ and Frances Amonda Davidson²⁷⁵, as shown in family tree 52.
(Nelson married three times. He was married to Cecelia Kay Pendergrass¹⁷⁵, Claudette Irene Corlett¹⁷⁶ and Lorraine Madden¹⁷⁷.)
175. CECELIA KAY PENDERGRASS (James's great-great-great-grandson's wife).

- Nelson Chester Whitman¹⁷⁴ married Cecelia Kay Pendergrass. They had two children:
 Robbyn Cherter Whitman⁸⁷ in 1959
 Peri Ann Whitman⁸⁸ in 1960
This family is shown as family tree 29.
176. CLAUDETTE IRENE CORLETT (James's great-great-great-grandson's wife).
 Nelson Chester Whitman¹⁷⁴ married Claudette Irene Corlett. They had one son:
 Marcus Pine Whitman⁸⁹ in 1962
This family is shown as family tree 30.
177. LORRAINE MADDEN (James's great-great-great-grandson's wife) was born in 1962.
 Nelson Chester Whitman¹⁷⁴ married Lorraine Madden.
178. BOYD DAVID WHITMAN (James's great-great-great-grandson) was born in 1940 in BigPiney, Sublette, Wyoming, USA to Bruce Douglas Whitman²⁷⁶ and Frances Amonda Davidson²⁷⁵, as shown in family tree 52.
179. CAROLYN M THOMPSON (James's great-great-great-grandson's wife).
 Boyd David Whitman¹⁷⁸ married Carolyn M Thompson. They had three children:
 Micheal Gerald Sturm Whitman⁹⁰ in 1968
 Patrick Keith Whitman⁹¹ in 1969
 Nathanielle Rebecca Whitman⁹² in 1973
This family is shown as family tree 31.
180. RICHARD WARD WHITMAN (James's great-great-great-grandson) was born in 1941 in BigPiney, Sublette, Wyoming, USA to Bruce Douglas Whitman²⁷⁶ and Frances Amonda Davidson²⁷⁵, as shown in family tree 52.
181. ROBIN KNIPP JOUETT (James's great-great-great-grandson's wife).
 Richard Ward Whitman¹⁸⁰ married Robin Knipp Jouett. They had two children:
 Grant Douglas Whitman⁹³ in 1967
 Gail Robin Whitman⁹⁴ in 1968
This family is shown as family tree 32.
182. CHARLOTTE LOUIZE WHITMAN (James's great-great-great-granddaughter) was born in 1944 in BigPiney, Sublette, Wyoming, USA to Bruce Douglas Whitman²⁷⁶ and Frances Amonda Davidson²⁷⁵, as shown in family tree 52.
183. JOSEPH GRANT BARTLETT (James's great-great-great-granddaughter's husband).
 Joseph Grant Bartlett married Charlotte Louize Whitman¹⁸². They had three children:
 Tori Dawn Bartlett⁹⁵ in 1963
 Travis Darryl Bartlett⁹⁶ in 1969
 Trevor David Bartlett⁹⁷ in 1974
This family is shown as family tree 33.
184. MARCELLA ANN WHITMAN (James's great-great-great-granddaughter) was born in 1946 to Bruce Douglas Whitman²⁷⁶ and Frances Amonda Davidson²⁷⁵, as shown in family tree 52.
185. TOMMY M THOMPSON (James's great-great-great-granddaughter's husband).
 Tommy M Thompson married Marcella Ann Whitman¹⁸⁴. They had one son:
 Bradly Tommy Thompson⁹⁸ in 1966
This family is shown as family tree 34.
186. PHILLIS LANA WHITMAN (James's great-great-great-granddaughter) was born in 1948 to Bruce Douglas Whitman²⁷⁶ and Frances Amonda Davidson²⁷⁵, as shown in family tree 52.
187. FRED WINTON SMITH (James's great-great-great-granddaughter's husband).
 Fred Winton Smith married Phillis Lana Whitman¹⁸⁶. They had two children:
 Fred Winton Smith⁹⁹ in 1967
 Collin Wade Whitman¹⁰⁰ in 1969
This family is shown as family tree 35.
188. LAUREL ALICE WHITMAN (James's great-great-great-granddaughter) was born in 1952 to Bruce Douglas Whitman²⁷⁶ and Frances Amonda Davidson²⁷⁵, as shown in family tree 52.
 (Laurel married twice. She was married to Stanley Howard Self¹⁸⁹ and Everett Michael Corlett¹⁹⁰.)
189. STANLEY HOWARD SELF (James's great-great-great-granddaughter's husband).
 Stanley Howard Self married Laurel Alice Whitman¹⁸⁸. They had three children:
 Stuart Branson Self¹⁰¹ in 1974
 Ian Mathew Self¹⁰² in 1975
 Ashley Chester Self¹⁰³ in 1977
This family is shown as family tree 36.
190. EVERETT MICHAEL CORLETT (James's great-great-great-granddaughter's husband).

Everett Michael Corlett married Laurel Alice Whitman¹⁸⁸.

191. CHARLES WHITMAN (James's great-great-great-grandson) was born in 1957 to Bruce Douglas Whitman²⁷⁶ and Frances Amonda Davidson²⁷⁵, as shown in family tree 52.
192. ROBERT HARRY ROGERSON (James's great-great-great-grandson) was born in 1942 to Robert Orrin Rogerson²⁷⁸ and Vita Maude Davidson²⁷⁷, as shown in family tree 53. Robert died in 1953, aged about 11.
193. WILMA ELAINE ROGERSON (James's great-great-great-granddaughter) was born in 1948 to Robert Orrin Rogerson²⁷⁸ and Vita Maude Davidson²⁷⁷, as shown in family tree 53. Wilma died in 1965, aged about 17.
194. RUTH ORRINE ROGERSON (James's great-great-great-granddaughter) was born in 1949 to Robert Orrin Rogerson²⁷⁸ and Vita Maude Davidson²⁷⁷, as shown in family tree 53.
195. ROGER CAYLOR (James's great-great-great-granddaughter's husband).
Roger Caylor married Ruth Orrine Rogerson¹⁹⁴.
196. KATHERYNE LOUIZE BLACKBURN (James's great-great-great-granddaughter) was born in 1946 to Harvey Alton Blackburn²⁸² and Louise Gertrude Davidson²⁸¹, as shown in family tree 54.
197. EDWARD J MCCREA (James's great-great-great-granddaughter's husband) was born in 1945.
Edward J McCrea married Katheryne Louise Blackburn¹⁹⁶.
198. HARVEY DAVID BLACKBURN (James's great-great-great-grandson) was born in 1953 to Harvey Alton Blackburn²⁸² and Louise Gertrude Davidson²⁸¹, as shown in family tree 54.
199. CELESTE MARIE HOFFMAN (James's great-great-great-grandson's wife) was born in 1963.
Harvey David Blackburn¹⁹⁸ married Celeste Marie Hoffman.
200. DANIEL CLARK DAVIDSON (James's great-great-great-grandson) was born in 1949 to Chester Clark Davidson²⁸³ and Norma Hilda Dadisman²⁸⁴, as shown in family tree 55.
201. JEAN MARIE DAVIDSON (James's great-great-great-granddaughter) was born in 1954 to Chester Clark Davidson²⁸³ and Norma Hilda Dadisman²⁸⁴, as shown in family tree 55.
202. GARRETT DAVID ACKERSON (James's great-great-great-grandson) was born in 1943 to Walter Cecil Ackerson²⁸⁶ and Eleanora Alice Davidson²⁸⁵, as shown in family tree 56.
203. EVELYN ANDERSON (James's great-great-great-grandson's wife) was born in 1948.
Garrett David Ackerson²⁰² married Evelyn Anderson.
204. TERRY WALTER ACKERSON (James's great-great-great-grandson) was born in 1945 to Walter Cecil Ackerson²⁸⁶ and Eleanora Alice Davidson²⁸⁵, as shown in family tree 56.
(Terry married twice. He was married to Kay Harding²⁰⁵ and Patricia Cox²⁰⁶.)
205. KAY HARDING (James's great-great-great-grandson's wife) was born in 1946.
Terry Walter Ackerson²⁰⁴ married Kay Harding.
206. PATRICIA COX (James's great-great-great-grandson's wife) was born in 1946.
Terry Walter Ackerson²⁰⁴ married Patricia Cox.
207. WESLEY CECIL ACKERSON (James's great-great-great-grandson) was born in 1947 to Walter Cecil Ackerson²⁸⁶ and Eleanora Alice Davidson²⁸⁵, as shown in family tree 56.
208. KRISTY LEE ARY (James's great-great-great-grandson's wife) was born in 1955.
Wesley Cecil Ackerson²⁰⁷ married Kristy Lee Ary.
209. DANNY RAY ACKERSON (James's great-great-great-grandson) was born in 1948 to Walter Cecil Ackerson²⁸⁶ and Eleanora Alice Davidson²⁸⁵, as shown in family tree 56.
210. NANCY SUE KURTH (James's great-great-great-grandson's wife) was born in 1950.
Danny Ray Ackerson²⁰⁹ married Nancy Sue Kurth.
211. SUELLEN LOUISE DAVIDSON (James's great-great-great-granddaughter) was born in 1951 to Charles Daniel Davidson²⁸⁷ and Earlene Dee Noller²⁸⁸, as shown in family tree 57.
212. JOHN ELLERY MASTERS (James's great-great-great-granddaughter's husband) was born in 1953.
John Ellery Masters married Suellen Louise Davidson²¹¹.
213. DEBORAH JEANE DAVIDSON (James's great-great-great-granddaughter) was born to Charles Daniel Davidson²⁸⁷ and Earlene Dee Noller²⁸⁸, as shown in family tree 57.
(Deborah married twice. She was married to Charles William Nation, Jr.²¹⁴ and Gerald Noller Tomayer²¹⁵.)

214. CHARLES WILLIAM NATION, JR. (James's great-great-great-granddaughter's husband).
Charles William Nation, Jr. married Deborah Jeane Davidson²¹³.
215. GERALD NOLLER TOMAYER (James's great-great-great-granddaughter's husband) was born in 1960.
Gerald Noller Tomayer married Deborah Jeane Davidson²¹³.
216. CHARLES NOLLER DAVIDSON (James's great-great-great-grandson) was born in 1960 to Charles Daniel Davidson²⁸⁷ and Earlene Dee Noller²⁸⁸, as shown in family tree 57.
217. TONIA JENKINS (James's great-great-great-grandson's wife).
Charles Noller Davidson²¹⁶ married Tonia Jenkins.
218. KEREN LYNNE HARNED (James's great-great-great-granddaughter) was born in 1963 to David Debernardi Harned²⁹⁰ and Myrtle Rae Davidson²⁸⁹, as shown in family tree 58.
219. RICHARD LEE WELLS (James's great-great-great-granddaughter's husband) was born in 1962.
Richard Lee Wells married Keren Lynne Harned²¹⁸.
220. KATHLEEN MARIE REDMAN (James's great-great-great-granddaughter) was born in 1965 to Ronald Clark Redman²⁹¹ and Myrtle Rae Davidson²⁸⁹, as shown in family tree 59.
(Kathleen married three times. She was married to Timothy Tol Johnson²²¹, Richard Ferrin²²² and Jamie Paul Shoemaker²²³.)
221. TIMOTHY TOL JOHNSON (James's great-great-great-granddaughter's husband).
Timothy Tol Johnson married Kathleen Marie Redman²²⁰.
222. RICHARD FERRIN (James's great-great-great-granddaughter's husband).
Richard Ferrin married Kathleen Marie Redman²²⁰.
223. JAMIE PAUL SHOEMAKER (James's great-great-great-granddaughter's husband).
Jamie Paul Shoemaker married Kathleen Marie Redman²²⁰.
224. KATHRYN VICTORIA REDMAN (James's great-great-great-granddaughter) was born in 1970 to Ronald Clark Redman²⁹¹ and Myrtle Rae Davidson²⁸⁹, as shown in family tree 59.
225. RONNIE WESLEY REDMAN (James's great-great-great-grandson) was born in 1974 to Ronald Clark Redman²⁹¹ and Myrtle Rae Davidson²⁸⁹, as shown in family tree 59.
226. LINDA ANN CAIRNS (James's great-great-great-granddaughter) was born in 1950 to Jack Lavoy Cairns²⁹⁴ and Beverly Ann Johnson²⁹⁵, as shown in family tree 60.
227. RONALD OTIS PAGE (James's great-great-great-granddaughter's husband) was born in 1950 in Colorado Springs, El Paso, Colorado, USA.
Ronald Otis Page married Linda Ann Cairns²²⁶. They had three children:
Thomas Elliott Page¹⁰⁴ in 1971
Johnathan Jack Page¹⁰⁵ in 1973
Donald Grant Page¹⁰⁶ in 1975
This family is shown as family tree 37.
228. CHRISTINE MARIE CAIRNS (James's great-great-great-granddaughter) was born in 1951 in Rawlins, Carbon, Wyoming, USA to Jack Lavoy Cairns²⁹⁴ and Beverly Ann Johnson²⁹⁵, as shown in family tree 60.
229. CRAIG CAMPBELL (James's great-great-great-granddaughter's husband) was born in 1955.
Craig Campbell married Christine Marie Cairns²²⁸. They had three children:
Triana Marie Campbell¹⁰⁷ in 1978
Holly Ann Campbell¹⁰⁸ in 1980
Eric Raymond Campbell¹⁰⁹ in 1985
This family is shown as family tree 38.
230. JACK LAVOY CAIRNS, JR. (James's great-great-great-grandson) was born in 1953 in Rock Springs, Sweetwater, Wyoming, USA to Jack Lavoy Cairns²⁹⁴ and Beverly Ann Johnson²⁹⁵, as shown in family tree 60.
231. REBECCA CASSLER (James's great-great-great-grandson's wife) was born in 1955.
Jack Lavoy Cairns, Jr.²³⁰ married Rebecca Cassler. They had two children:
Rachel Elizabeth Cairns¹¹⁰ in 1979
Mary Melissa Cairns¹¹¹ in 1983
This family is shown as family tree 39.
232. ELIZABETH KAY CAIRNS (James's great-great-great-granddaughter) was born in 1954 in Rawlins, Carbon, Wyoming, USA to Jack Lavoy Cairns²⁹⁴ and Beverly Ann Johnson²⁹⁵, as shown in family tree 60.
233. ALAN HANSEN (James's great-great-great-granddaughter's husband).

Alan Hansen married Elizabeth Kay Cairns²³². They had five children:

Jeremy Alan Hansen¹¹² in 1975
 Aaron Wayne Hansen¹¹³ in 1976
 Michael Brent Hansen¹¹⁴ in 1979
 Amy Nicole Hansen¹¹⁵ in 1981
 Jacob Karl Hansen¹¹⁶ in 1983

This family is shown as family tree 40.

234. WILLIAM WAYNE CAIRNS (James's great-great-great-grandson) was born in 1955 in Rawlins, Carbon, Wyoming, USA to Jack Lavoy Cairns²⁹⁴ and Beverly Ann Johnson²⁹⁵, as shown in family tree 60.

235. KAE PORTER (James's great-great-great-grandson's wife) was born in 1957 in Ceder City, Iron, Utah, USA.

William Wayne Cairns²³⁴ married Kae Porter. They had three children:

Dorci Kae Cairns¹¹⁷ in 1983
 Jace William Cairns¹¹⁸ in 1988
 Brindi Michelle Cairns¹¹⁹ in 1991

This family is shown as family tree 41.

236. REBECCA GAY CAIRNS (James's great-great-great-granddaughter) was born in 1956 in Rawlins, Carbon, Wyoming, USA to Jack Lavoy Cairns²⁹⁴ and Beverly Ann Johnson²⁹⁵, as shown in family tree 60.

237. JOHN ELLERY COOPER (James's great-great-great-granddaughter's husband) was born in 1954 in Yonkers, New York, USA.

John Ellery Cooper married Rebecca Gay Cairns²³⁶. They had two children:

Tiffany Anne Cooper¹²⁰ in 1977
 Hillary Rane Cooper¹²² in 1978

This family is shown as family tree 42.

238. RICHARD NORMAN WILSON (James's great-great-great-grandson) was born in 1953 in Rawlins, Carbon, Wyoming, USA to Albert Norman Wilson²⁹⁷ and Margaret Faunita Cairns²⁹⁶, as shown in family tree 61.

239. KENNETH LOGAN WILSON (James's great-great-great-grandson) was born in 1954 in Rawlins, Carbon, Wyoming, USA to Albert Norman Wilson²⁹⁷ and Margaret Faunita Cairns²⁹⁶, as shown in family tree 61.

240. PHYLLIS ANN WILSON (James's great-great-great-granddaughter) was born in 1955 in Rawlins, Carbon, Wyoming, USA to Albert Norman Wilson²⁹⁷ and Margaret Faunita Cairns²⁹⁶, as shown in family tree 61.

241. CARLIE JEBENS (James's great-great-great-granddaughter's husband).

Carlie Jebens married Phyllis Ann Wilson²⁴⁰. They had three children:

Kreeta Ann Jebens¹²³ in 1975
 Korey Kay Jebens¹²⁴ in 1977
 Carlie Norman Jebens¹²⁵ in 1979

This family is shown as family tree 43.

242. TYLER MARTIN SCHMELING (James's great-great-great-grandson) was born in 1976 in Weatland, Platte, Wyoming, USA to Craig Martin Schmeling³⁰⁰ and Judy Ann Cairns²⁹⁹, as shown in family tree 62.

243. AMY NICHOLE SCHMELING (James's great-great-great-granddaughter) was born in 1978 in Cheyenne, Laramie, Wyoming, USA to Craig Martin Schmeling³⁰⁰ and Judy Ann Cairns²⁹⁹, as shown in family tree 62.

Generation of Great-Great-Grandchildren

244. GRACE PETERS (James's great-great-granddaughter) was born to Fred Peters³⁰⁹ and Rosa Marie Kennaday³⁰⁸, as shown in family tree 63.

245. JOHN PETERS (James's great-great-grandson) was born to Fred Peters³⁰⁹ and Rosa Marie Kennaday³⁰⁸, as shown in family tree 63.

246. MABLE VILOTE STEWART (James's great-great-granddaughter) was born in 1906 to Ed Stewart³¹¹ and Anna Ruth Kennaday³¹⁰, as shown in family tree 64.

247. FRANCES LUELLA STEWART (James's great-great-granddaughter) was born in 1909 to Ed Stewart³¹¹ and Anna Ruth Kennaday³¹⁰, as shown in family tree 64.

248. GEORGE MARTIN STEWART (James's great-great-grandson) was born in 1912 to Ed Stewart³¹¹ and Anna Ruth Kennaday³¹⁰, as shown in family tree 64.

249. OLIVE RUTH STEWART (James's great-great-granddaughter) was born in 1921 in Blue Lake, Humboldt, California, USA to Ed Stewart³¹¹ and Anna Ruth Kennaday³¹⁰, as shown in family tree 64.
250. CHARLES LEROY STEWART (James's great-great-grandson) was born in 1929 in Blue Lake, Humboldt, California, USA to Ed Stewart³¹¹ and Anna Ruth Kennaday³¹⁰, as shown in family tree 64. Charles died in 1996, aged about 67.
251. LUCY UNKNOWN (James's great-great-grandson's wife).
Charles Leroy Stewart²⁵⁰ married Lucy Unknown.
252. THOMAS EARL KENNADAY (James's great-great-grandson) was born on 7 July 1914 in Saratoga, Carbon, Wyoming, USA to Frank Forest Kennaday³¹⁶ and Mable Pierce³¹⁷, as shown in family tree 65.
253. GLADYS ELEANOR REAM (James's great-great-grandson's wife) was born in 1914 in Superior, Colorado, USA. Gladys died in 1990, aged about 76.
Thomas Earl Kennaday²⁵², aged 18, married Gladys Eleanor Ream, aged about 18, on 13 May 1933 in Rawlins, Carbon, Wyoming, USA. They had three children:
Charlotte Arlene Kennaday¹²⁶ in 1933
Thomas Eugene Kennaday¹²⁸ in 1935
Patty Ray Kennaday¹³⁰ in 1937
This family is shown as family tree 44.
254. FLORENCE MAE KENNADAY (James's great-great-granddaughter) was born on 28 June 1917 in Saratoga, Carbon, Wyoming, USA to Frank Forest Kennaday³¹⁶ and Mable Pierce³¹⁷, as shown in family tree 65.
(Florence married twice. She was married to Mr. Bray²⁵⁵ and Earl N Ramsey²⁵⁶.)
255. MR. BRAY (James's great-great-granddaughter's husband).
Mr. Bray married Florence Mae Kennaday²⁵⁴.
256. EARL N RAMSEY (James's great-great-granddaughter's husband) was born in 1911.
Earl N Ramsey, aged about 24, married Florence Mae Kennaday²⁵⁴, aged 18, on 21 October 1935. They had two children:
Earl Efton (Butch) Ramsey¹³² in 1937
Afton Ernstine (Marier) Ramsey¹³⁴
This family is shown as family tree 45.
257. FOREST JACK KENNADAY (James's great-great-grandson) was born on 22 November 1919 in Saratoga, Carbon, Wyoming, USA to Frank Forest Kennaday³¹⁶ and Mable Pierce³¹⁷, as shown in family tree 65.
258. ELLEN (DUDE) STOCKWELL (James's great-great-granddaughter's husband) was born in 1919 in Saratoga, Carbon, Wyoming, USA.
Ellen (Dude) Stockwell, aged about 25, married Forest Jack Kennaday²⁵⁷, aged 25, on 9 June 1945. They had three children:
Jack Wayne Kennaday¹³⁶ in 1939
Gary Forrest Kennaday¹³⁸ in 1942
Michael Joseph Kennaday¹⁴¹
This family is shown as family tree 46.
259. ROSE MARIE KENNADAY (James's great-great-granddaughter) was born on 10 October 1921 in Saratoga, Carbon, Wyoming, USA to Frank Forest Kennaday³¹⁶ and Mable Pierce³¹⁷, as shown in family tree 65.
260. CALVIN LOTT (James's great-great-granddaughter's husband).
Calvin Lott married Rose Marie Kennaday²⁵⁹. They had six children:
Jimmy Ray Lott¹⁴³ in 1940
Rosa Lee Lott¹⁴⁵
Calvin Jay Lott¹⁴⁷
Mable Bea Lott¹⁴⁹
John Lott¹⁵²
Randy Eugene Lott¹⁵³ in 1962
This family is shown as family tree 47.
261. IVA JUNE KENNADAY (James's great-great-granddaughter) was born on 13 June 1923 in Saratoga, Carbon, Wyoming, USA to Frank Forest Kennaday³¹⁶ and Mable Pierce³¹⁷, as shown in family tree 65. Iva died on 16 March 2005, aged 81, in Indianapolis, Indiana, USA. She was buried in Carlisle Cemetery, Carlisle, Kentucky.
Note: *Although my children were born before wedding. This is the true mother and father and God has blessed this union.*
262. JOHN DAVID KELLEY (James's great-great-granddaughter's husband) was born on 28 December 1917 to Talmadge Blane Kelley⁴⁴² and Mary Elizabeth Minton⁴⁴³. He became a Grocery, Service Station. John died on 21 April 1970, aged 52, of Liver, in Carlisle, Kentucky, USA. He was buried in Carlisle Cemetery, Carlisle Kentucky.
[See also: Indirectly related via John David Kelley]

Note: John D joined the Army on November 19, 1942 in Carlisle Kentucky. Was a Corporal in the 306th unit at Cincinnati, Ohio and served as a Cook at the Pueblo Air Force Base in Salt Lake City. He was Discharged on April 8, 1943 with rank of Corporal. His Serial Number was 35455610 It was a wonderful blessing from God the day he influenced John D to stop the drinking habit and become a real husband and father. We know that it happened through God's help and we send a prayer every day, hour, minute.

John David Kelley, aged 30, married Iva June Kennaday²⁶¹, aged 25, on 8 August 1948 in Flemmingburg, Kentucky, USA. They had two children:

Ronald David Kelley, Sr.¹⁵⁴ in 1943

Carolyn June Kelley¹⁵⁶ in 1945

This family is shown as family tree 48.

263. BONNIE JEAN KENNADAY (James's great-great-granddaughter) was born on 6 April 1925 to Frank Forest Kennaday³¹⁶ and Mable Pierce³¹⁷, as shown in family tree 65.

(Bonnie married twice. She was married to Gordon Johnson²⁶⁴ and James Martin Marier²⁶⁵.)

264. GORDON JOHNSON (James's great-great-granddaughter's husband).

Gordon Johnson married Bonnie Jean Kennaday²⁶³. They had two children:

Stanley Johnson¹⁵⁸

Scott Johnson¹⁵⁹

This family is shown as family tree 49.

265. JAMES MARTIN MARIER (James's great-great-granddaughter's husband) was born on 22 February 1920 in El Vado, Rio Arriba, New Mexico, USA. James died in 1999, aged about 79.

James Martin Marier, aged 28, married Bonnie Jean Kennaday²⁶³, aged 23, on 6 April 1948. They had two children:

Sherry Jean Marier¹⁶⁰ in 1942

Jane Marie Marier¹⁶³ in 1945

This family is shown as family tree 50.

266. LINCOLN FRANK KENNADAY (James's great-great-grandson) was born on 9 April 1928 in Saratoga, Carbon, Wyoming, USA to Frank Forest Kennaday³¹⁶ and Mable Pierce³¹⁷, as shown in family tree 65.

267. JOAN OLIVIA DEBERNARDI (James's great-great-grandson's wife) was born on 30 April 1929 in Roseburg, Douglas, Oregon, USA.

Lincoln Frank Kennaday²⁶⁶, aged 17, married Joan Olivia Debernardi, aged 16, on 25 October 1945. They had four children:

Gary Jo Kennaday¹⁶⁵ in 1946

David Debernardi Kennaday¹⁶⁷ in 1949

Steven Scott Kennaday¹⁶⁹ in 1956

Fredrick Frank Kennaday¹⁷² in 1957

This family is shown as family tree 51.

268. WILLIAM C KENNADAY (James's great-great-grandson) was born in 1920 in Saratoga, Carbon, Wyoming, USA to Edward Thomas Kennaday³¹⁸ and Alice Mannahan³¹⁹, as shown in family tree 66. William died in 1920 as an infant.

269. JOHN E KENNADAY (James's great-great-grandson) was born in 1927 in Saratoga, Carbon, Wyoming, USA to Edward Thomas Kennaday³¹⁸ and Alice Mannahan³¹⁹, as shown in family tree 66. John died in 1927 as an infant.

270. MARY LOU KENNADAY (James's great-great-granddaughter) was born in 1931 in Saratoga, Carbon, Wyoming, USA to Edward Thomas Kennaday³¹⁸ and Alice Mannahan³¹⁹, as shown in family tree 66. Mary died in 1972, aged about 41.

271. CATHERINE MARIE KENNADAY (James's great-great-granddaughter) was born in 1931 in Saratoga, Carbon, Wyoming, USA to Edward Thomas Kennaday³¹⁸ and Alice Mannahan³¹⁹, as shown in family tree 66. Catherine died in 1936, aged about 5.

272. FRED E KENNADAY (James's great-great-grandson) was born in 1932 in Saratoga, Carbon, Wyoming, USA to Edward Thomas Kennaday³¹⁸ and Alice Mannahan³¹⁹, as shown in family tree 66. Fred died in 1933, aged about 1.

273. JAMES KENNADAY (James's great-great-grandson) was born to Edward Thomas Kennaday³¹⁸ and Alice Mannahan³¹⁹, as shown in family tree 66.

274. ALICE ANN KENNADAY (James's great-great-granddaughter) was born in 1938 in Saratoga, Carbon, Wyoming, USA to Edward Thomas Kennaday³¹⁸ and Alice Mannahan³¹⁹, as shown in family tree 66. Alice died in 1985, aged about 47.

275. FRANCES AMONDA DAVIDSON (James's great-great-granddaughter) was born in 1917 in Denver, Adams, Colorado, USA to Fairfax Harry Davidson³²¹ and Alice Oda May Kennaday³²⁰, as shown in family tree 67.

276. BRUCE DOUGLAS WHITMAN (James's great-great-granddaughter's husband) was born in 1920. (Bruce married three times. He was married to Frances Amonda Davidson²⁷⁵, Claudette Irene Corlett⁴⁷⁵ and Lorraine Madden⁴⁷⁶.)
[See also: Indirectly related via Bruce Douglas Whitman]
 Bruce Douglas Whitman married Frances Amonda Davidson²⁷⁵. They had eight children:
 Nelson Chester Whitman¹⁷⁴ in 1939
 Boyd David Whitman¹⁷⁸ in 1940
 Richard Ward Whitman¹⁸⁰ in 1941
 Charlotte Louise Whitman¹⁸² in 1944
 Marcella Ann Whitman¹⁸⁴ in 1946
 Phillis Lana Whitman¹⁸⁶ in 1948
 Laurel Alice Whitman¹⁸⁸ in 1952
 Charles Whitman¹⁹¹ in 1957
This family is shown as family tree 52.
277. VITA MAUDE DAVIDSON (James's great-great-granddaughter) was born in 1918 in Saratoga, Carbon, Wyoming, USA to Fairfax Harry Davidson³²¹ and Alice Oda May Kennaday³²⁰, as shown in family tree 67. (Vita married three times. She was married to Robert Orrin Rogerson²⁷⁸, Douglas Turner Cairns²⁷⁹ and Vyrl M Schilling²⁸⁰.)
278. ROBERT ORRIN ROGERSON (James's great-great-granddaughter's husband) was born in 1918. Robert Orrin Rogerson married Vita Maude Davidson²⁷⁷. They had three children:
 Robert Harry Rogerson¹⁹² in 1942
 Wilma Elaine Rogerson¹⁹³ in 1948
 Ruth Orrine Rogerson¹⁹⁴ in 1949
This family is shown as family tree 53.
279. DOUGLAS TURNER CAIRNS (James's great-great-granddaughter's husband). Douglas Turner Cairns married Vita Maude Davidson²⁷⁷.
280. VYRL M SCHILLING (James's great-great-granddaughter's husband). Vyrl M Schilling married Vita Maude Davidson²⁷⁷.
281. LOUIZE GERTRUDE DAVIDSON (James's great-great-granddaughter) was born in 1920 in Saratoga, Carbon, Wyoming, USA to Fairfax Harry Davidson³²¹ and Alice Oda May Kennaday³²⁰, as shown in family tree 67.
282. HARVEY ALTON BLACKBURN (James's great-great-granddaughter's husband) was born in 1915. Harvey Alton Blackburn married Louise Gertrude Davidson²⁸¹. They had two children:
 Kathyne Louise Blackburn¹⁹⁶ in 1946
 Harvey David Blackburn¹⁹⁸ in 1953
This family is shown as family tree 54.
283. CHESTER CLARK DAVIDSON (James's great-great-grandson) was born in 1921 to Fairfax Harry Davidson³²¹ and Alice Oda May Kennaday³²⁰, as shown in family tree 67.
284. NORMA HILDA DADISMAN (James's great-great-grandson's wife). Chester Clark Davidson²⁸³ married Norma Hilda Dadisman. They had two children:
 Daniel Clark Davidson²⁰⁰ in 1949
 Jean Marie Davidson²⁰¹ in 1954
This family is shown as family tree 55.
285. ELEANORA ALICE DAVIDSON (James's great-great-granddaughter) was born in 1923 to Fairfax Harry Davidson³²¹ and Alice Oda May Kennaday³²⁰, as shown in family tree 67.
286. WALTER CECIL ACKERSON (James's great-great-granddaughter's husband) was born in 1913. Walter Cecil Ackerson married Eleanora Alice Davidson²⁸⁵. They had four children:
 Garrett David Ackerson²⁰² in 1943
 Terry Walter Ackerson²⁰⁴ in 1945
 Wesley Cecil Ackerson²⁰⁷ in 1947
 Danny Ray Ackerson²⁰⁹ in 1948
This family is shown as family tree 56.
287. CHARLES DANIEL DAVIDSON (James's great-great-grandson) was born in 1927 to Fairfax Harry Davidson³²¹ and Alice Oda May Kennaday³²⁰, as shown in family tree 67.
288. EARLENE DEE NOLLER (James's great-great-grandson's wife) was born in 1929. Charles Daniel Davidson²⁸⁷ married Earlene Dee Noller. They had three children:
 Suellen Louise Davidson²¹¹ in 1951
 Deborah Jeane Davidson²¹³
 Charles Noller Davidson²¹⁶ in 1960
This family is shown as family tree 57.

289. MYRTLE RAE DAVIDSON (James's great-great-granddaughter) was born in 1929 to Fairfax Harry Davidson³²¹ and Alice Oda May Kennaday³²⁰, as shown in family tree 67.
(Myrtle married twice. She was married to David Debernardi Harned²⁹⁰ and Ronald Clark Redman²⁹¹.)
290. DAVID DEBERNARDI HARNED (James's great-great-granddaughter's husband).
David Debernardi Harned married Myrtle Rae Davidson²⁸⁹. They had one daughter:
Keren Lynne Harned²¹⁸ in 1963
This family is shown as family tree 58.
291. RONALD CLARK REDMAN (James's great-great-granddaughter's husband) was born in 1935.
Ronald Clark Redman married Myrtle Rae Davidson²⁸⁹. They had three children:
Kathleen Marie Redman²²⁰ in 1965
Kathryn Victoria Redman²²⁴ in 1970
Ronnie Wesley Redman²²⁵ in 1974
This family is shown as family tree 59.
292. FRANCES ANN KENNADAY (James's great-great-granddaughter) was born to Charles Fredrick Kennaday³²² and Margaret Bays³²³, as shown in family tree 68.
293. THOMAS DEAN LUCAS (James's great-great-granddaughter's husband).
Thomas Dean Lucas married Frances Ann Kennaday²⁹².
294. JACK LAVOY CAIRNS (James's great-great-grandson) was born in 1930 in Rawlins, Carbon, Wyoming, USA to Logan Turner Cairns³²⁵ and Emma Helen Kennaday³²⁴, as shown in family tree 69.
295. BEVERLY ANN JOHNSON (James's great-great-grandson's wife) was born in 1928 in Hanna, Carbon, Wyoming, USA.
Jack Lavoy Cairns²⁹⁴ married Beverly Ann Johnson. They had six children:
Linda Ann Cairns²²⁶ in 1950
Christine Marie Cairns²²⁸ in 1951
Jack Lavoy Cairns, Jr.²³⁰ in 1953
Elizabeth Kay Cairns²³² in 1954
William Wayne Cairns²³⁴ in 1955
Rebecca Gay Cairns²³⁶ in 1956
This family is shown as family tree 60.
296. MARGARET FAUNITA CAIRNS (James's great-great-granddaughter) was born in 1933 in Rawlins, Carbon, Wyoming, USA to Logan Turner Cairns³²⁵ and Emma Helen Kennaday³²⁴, as shown in family tree 69.
297. ALBERT NORMAN WILSON (James's great-great-granddaughter's husband).
Albert Norman Wilson married Margaret Faunita Cairns²⁹⁶. They had three children:
Richard Norman Wilson²³⁸ in 1953
Kenneth Logan Wilson²³⁹ in 1954
Phyllis Ann Wilson²⁴⁰ in 1955
This family is shown as family tree 61.
298. DOROTHY LARRAINE CAIRNS (James's great-great-granddaughter) was born in 1941 in Rawlins, Carbon, Wyoming, USA to Logan Turner Cairns³²⁵ and Emma Helen Kennaday³²⁴, as shown in family tree 69. Dorothy died in 1942, aged about 1.
299. JUDY ANN CAIRNS (James's great-great-granddaughter) was born in 1946 in Rawlins, Carbon, Wyoming, USA to Logan Turner Cairns³²⁵ and Emma Helen Kennaday³²⁴, as shown in family tree 69.
300. CRAIG MARTIN SCHMELING (James's great-great-granddaughter's husband) was born in 1945 in Whittemore, Platte, Wyoming, USA.
Craig Martin Schmeling married Judy Ann Cairns²⁹⁹. They had two children:
Tyler Martin Schmeling²⁴² in 1976
Amy Nichole Schmeling²⁴³ in 1978
This family is shown as family tree 62.
301. JACK J KENNADAY (James's great-great-grandson) was born on 18 September 1938 in Saratoga, Carbon, Wyoming, USA to Loyd Andrew Kennaday³²⁶ and Inez Henderson³²⁷, as shown in family tree 70.
302. CARL L KENNADAY (James's great-great-grandson) was born on 18 December 1940 in Saratoga, Carbon, Wyoming, USA to Loyd Andrew Kennaday³²⁶ and Inez Henderson³²⁷, as shown in family tree 70.
303. CAROL BRUGUS (James's great-great-grandson's wife).
Carl L Kennaday³⁰², aged about 33, married Carol Brugus in 1974.
304. JOY L KENNADAY (James's great-great-granddaughter) was born on 17 April 1942 in Saratoga, Carbon, Wyoming, USA to Loyd Andrew Kennaday³²⁶ and Inez Henderson³²⁷, as shown in family tree 70.

305. JOHN JENNINGS (James's great-great-granddaughter's husband).
John Jennings married Joy L Kennaday³⁰⁴, aged about 19, in 1961.
306. DONALD FAY KENNADAY (James's great-great-grandson) was born on 18 May 1944 in Saratoga, Carbon, Wyoming, USA to Loyd Andrew Kennaday³²⁶ and Inez Henderson³²⁷, as shown in family tree 70.

Generation of Great-Grandchildren

307. SARAH ELIZABETH KENNADAY (James's great-granddaughter) was born on 1 November 1884 in Ceder Vale, Chautauqua, Kansas, USA to Charles Alonzo Kennaday³²⁹ and Frances Elizabeth Kennedy³³⁰, as shown in family tree 71. Sarah died on 1 November 1884 as an infant.
308. ROSA MARIE KENNADAY (James's great-granddaughter) was born on 22 January 1886 in Ceder Vale, Chautauqua, Kansas, USA to Charles Alonzo Kennaday³²⁹ and Frances Elizabeth Kennedy³³⁰, as shown in family tree 71. Rosa died on 22 July 1907, aged 21, in Saratoga, Wyoming.
309. FRED PETERS (James's great-granddaughter's husband).
Fred Peters married Rosa Marie Kennaday³⁰⁸, aged 18, on 7 March 1904 in Saratoga, Wyoming. They had two children:
Grace Peters²⁴⁴
John Peters²⁴⁵
This family is shown as family tree 63.
310. ANNA RUTH KENNADAY (James's great-granddaughter) was born on 30 January 1888 in Ceder Vale, Chautauqua, Kansas, USA to Charles Alonzo Kennaday³²⁹ and Frances Elizabeth Kennedy³³⁰, as shown in family tree 71. Anna died on 6 November 1959, aged 71, in Ceder Vale, Chautauqua, Kansas, USA.
311. ED STEWART (James's great-granddaughter's husband).
Ed Stewart married Anna Ruth Kennaday³¹⁰, aged 17, on 30 September 1905. They had five children:
Mable Vilote Stewart²⁴⁶ in 1906
Frances Luella Stewart²⁴⁷ in 1909
George Martin Stewart²⁴⁸ in 1912
Olive Ruth Stewart²⁴⁹ in 1921
Charles Leroy Stewart²⁵⁰ in 1929
This family is shown as family tree 64.
312. ALONSO KENNADAY (James's great-grandson) was born on 4 April 1889 in Ceder Vale, Chautauqua, Kansas, USA to Charles Alonzo Kennaday³²⁹ and Frances Elizabeth Kennedy³³⁰, as shown in family tree 71. Alonso died on 4 April 1889 as an infant.
313. HENRY GEORGE KENNADAY (James's great-grandson) was born on 11 May 1890 in Ceder Vale, Chautauqua, Kansas, USA to Charles Alonzo Kennaday³²⁹ and Frances Elizabeth Kennedy³³⁰, as shown in family tree 71. Henry died on 20 May 1901, aged 11.
314. HARRY OTIS KENNADAY (James's great-grandson) was born on 8 October 1892 in Saratoga, Carbon, Wyoming, USA to Charles Alonzo Kennaday³²⁹ and Frances Elizabeth Kennedy³³⁰, as shown in family tree 71. Harry died on 25 April 1940, aged 47, in Cheyenne, Laramie, Wyoming, USA. He was buried in Saratoga, Wyoming.
315. ESTER WEIBEL (James's great-grandson's wife).
Harry Otis Kennaday³¹⁴ married Ester Weibel.
316. FRANK FOREST KENNADAY (James's great-grandson) was born on 6 November 1893 in Saratoga, Carbon, Wyoming, USA to Charles Alonzo Kennaday³²⁹ and Frances Elizabeth Kennedy³³⁰, as shown in family tree 71. Frank died on 11 November 1955, aged 62.
Note: Forest's dad would get up at 5:00 AM in the morning and get everybody up and delegate chores to all the family even the girls had outside chores. After he delegated the chores he would go and take a nap until breakfast was ready. Forest didn't think that this was fair and even after he was grown he still didn't think this was fair. When Forest was only eleven and his brother Ed was age nine their father got them a job herding sheep. His dad would pick up their check and they wouldn't see a dime of the money. Forest said that these were hard times, especially at night, they were really scared. Forest had just finished the third grade when his dad put him out to work and no more schooling.
317. MABLE PIERCE (James's great-grandson's wife) was born on 5 January 1897 in Denver, Colorado to Thomas Earl Pearce⁴⁷⁹ and Mary Adele Lambs-Cobb⁴⁸¹. Mable died on 27 May 1940, aged 43, in Saratoga, Carbon, Wyoming, USA.
[See also: Indirectly related via Mable Pierce]

Note: When Mable and her Sister Alice were small girls their father Thomas and wife Mary Pearce left Denver and moved to Saratoga and homesteaded a piece of land outside of Saratoga toward the Rocky Mountains. It wasn't long after that Mary left Thomas and got custody of us. Thomas didn't stay in Saratoga long and when he decided to leave, he stole the two daughters and took them back to Denver with him. He had to work so he put the girls in an orphanage there and paid for their room and board at the orphanage. We cried for our mother a lot but my sister Alice was a great comfort to me at this time. Alice didn't like spinach so she wouldn't eat it when they put it on her plate. They kept putting it on her plate until she decided to eat it and she learned to like it while she was there. I don't know when Mary got her daughters back, but eventually we were back together in Saratoga, Wyoming. Mary went through the tenth grade in Saratoga at that time that was as far as high school went. She played on the basket ball team at Saratoga High. She was also an accomplished horseman. Horses were the only means of transportation when she was growing up. She played a mandolin and had a good singing voice. She sang at her church and sang many solos, but her husband Frank couldn't carry a tune. All of her babies were born at home.

Notes prepared by: Florence Kennaday.

Frank Forest Kennaday³¹⁶, aged 19, married Mable Pierce, aged 16, on 4 July 1913. They had seven children:

Thomas Earl Kennaday²⁵² in 1914
 Florence Mae Kennaday²⁵⁴ in 1917
 Forest Jack Kennaday²⁵⁷ in 1919
 Rose Marie Kennaday²⁵⁹ in 1921
 Iva June Kennaday²⁶¹ in 1923
 Bonnie Jean Kennaday²⁶³ in 1925
 Lincoln Frank Kennaday²⁶⁶ in 1928

This family is shown as family tree 65.

318. EDWARD THOMAS KENNADAY (James's great-grandson) was born on 9 October 1895 in Saratoga, Carbon, Wyoming, USA to Charles Alonzo Kennaday³²⁹ and Frances Elizabeth Kennedy³³⁰, as shown in family tree 71. Edward died on 16 October 1951, aged 56.
319. ALICE MANNAHAN (James's great-grandson's wife) was born in 1900 in Saratoga, Carbon, Wyoming, USA. Alice died in 1956, aged about 56.

Edward Thomas Kennaday³¹⁸, aged 22, married Alice Mannahan, aged about 18, on 11 August 1918. They had seven children:

William C Kennaday²⁶⁸ in 1920
 John E Kennaday²⁶⁹ in 1927
 Mary Lou Kennaday²⁷⁰ in 1931
 Catherine Marie Kennaday²⁷¹ in 1931
 Fred E Kennaday²⁷² in 1932
 James Kennaday²⁷³
 Alice Ann Kennaday²⁷⁴ in 1938

This family is shown as family tree 66.

320. ALICE ODA MAY KENNADAY (James's great-granddaughter) was born on 13 April 1897 in Saratoga, Carbon, Wyoming, USA to Charles Alonzo Kennaday³²⁹ and Frances Elizabeth Kennedy³³⁰, as shown in family tree 71. Alice died on 6 December 1979, aged 82, in Rawlins, Carbon, Wyoming, USA.
321. FAIRFAX HARRY DAVIDSON (James's great-granddaughter's husband) was born in 1894. Fairfax died in 1967, aged about 73.

Fairfax Harry Davidson, aged about 21, married Alice Oda May Kennaday³²⁰, aged 19, on 11 May 1916. They had seven children:

Frances Amonda Davidson²⁷⁵ in 1917
 Vita Maude Davidson²⁷⁷ in 1918
 Louise Gertrude Davidson²⁸¹ in 1920
 Chester Clark Davidson²⁸³ in 1921
 Eleanora Alice Davidson²⁸⁵ in 1923
 Charles Daniel Davidson²⁸⁷ in 1927
 Myrtle Rae Davidson²⁸⁹ in 1929

This family is shown as family tree 67.

322. CHARLES FREDRICK KENNADAY (James's great-grandson) was born on 30 November 1898 in Saratoga, Carbon, Wyoming, USA to Charles Alonzo Kennaday³²⁹ and Frances Elizabeth Kennedy³³⁰, as shown in family tree 71. Charles died on 6 December 1961, aged 63.

323. MARGARET BAYS (James's great-grandson's wife).

Charles Fredrick Kennaday³²², aged 34, married Margaret Bays on 18 July 1933. They had one daughter:

Frances Ann Kennaday²⁹²

This family is shown as family tree 68.

324. EMMA HELEN KENNADAY (James's great-granddaughter) was born on 8 December 1905 in Saratoga, Carbon, Wyoming, USA to Charles Alonzo Kennaday³²⁹ and Frances Elizabeth Kennedy³³⁰, as shown in family tree 71. Emma died on 26 August 1988, aged 82, in Rawlins, Carbon, Wyoming, USA. She was buried in Aug 30, 1988 Rawlins, Wyoming.
325. LOGAN TURNER CAIRNS (James's great-granddaughter's husband) was born in 1894 in Rawlins, Carbon, Wyoming, USA. Logan died in 1968, aged about 74.
Logan Turner Cairns, aged about 31, married Emma Helen Kennaday³²⁴, aged 19, on 3 December 1925 in Denver, Denver, Colorado, USA. They had four children:
Jack Lavoy Cairns²⁹⁴ in 1930
Margaret Faunita Cairns²⁹⁶ in 1933
Dorothy Lorraine Cairns²⁹⁸ in 1941
Judy Ann Cairns²⁹⁹ in 1946
This family is shown as family tree 69.
326. LOYD ANDREW KENNADAY (James's great-grandson) was born on 2 August 1903 in Saratoga, Carbon, Wyoming, USA to Andrew Jackson Kennaday³³⁷ and Anna Marshal³³⁸, as shown in family tree 72. Loyd died on 10 December 1983, aged 80.
327. INEZ HENDERSON (James's great-grandson's wife) was born on 3 February 1915. Inez died on 22 September 1991, aged 76, in Saratoga, Carbon, Wyoming, USA.
Loyd Andrew Kennaday³²⁶, aged 34, married Inez Henderson, aged 22, on 23 October 1937 in Saratoga, Carbon, Wyoming, USA. They had four children:
Jack J Kennaday³⁰¹ in 1938
Carl L Kennaday³⁰² in 1940
Joy L Kennaday³⁰⁴ in 1942
Donald Fay Kennaday³⁰⁶ in 1944
This family is shown as family tree 70.
328. FAY KENNADAY (James's great-granddaughter) was born on 14 June 1907 in Saratoga, Carbon, Wyoming, USA to Andrew Jackson Kennaday³³⁷ and Anna Marshal³³⁸, as shown in family tree 72. Fay died on 23 May 1974, aged 66.
Note: *Fay Killed a Bear with a 22 when she was only 12 years old.*

Generation of Grandchildren

329. CHARLES ALONZO KENNADAY (James's grandson) was born on 8 November 1856 in Clay, Kentucky, USA to John Hudson Kennaday³⁴⁰ and Anne Elizabeth Van Orsdel³⁴¹, as shown in family tree 73. He became a Rancher, Cowboy, Policeman. Charles died on 6 December 1940, aged 84, in Saratoga, Carbon, Wyoming, USA. He was buried in Dec. 9 1940 at Saratoga, Carbon, Wyoming, USA.
Note: *My brother Billy and sister Emma used to come and visit occasionally. When he was in his twenties he roade the Chisolm Trail on cattle drives where he meet his wife. They were married on November 11, 1883. In 1891 Charles & Frances left Kansas and moved to Saratoga, Wyoming. Charles pursued several occupations there, Rancher, Cowboy & Policeman. Charles also had a brother Jack that settled near Saratoga on a ranch. He had a ranch near his brother on Ceder Creek, not to far from Saratoga , about 16 miles. A mountain peak in that area is named after the two brothers. (Kennaday Peak).*
330. FRANCES ELIZABETH KENNEDY (James's grandson's wife) was born on 19 September 1864 in Zaleski, Venton, Ohio, USA to Jesse Rufus Kennedy⁵¹⁴ and Sarah Ann Ankrom⁵¹⁵. Frances died on 10 June 1938, aged 73, in Saratoga, Carbon, Wyoming, USA. She was buried in June 13 1938 Saratoga, Wyoming.
[See also: *Indirectly related via Frances Elizabeth Kennedy*]
Note: *When Frances was five years old , she and her parents moved to Ceder Vale Kansas in 1869. She became a member of the Church of Christ in Ceder Vale.*
Charles Alonzo Kennaday³²⁹, aged 27, married Frances Elizabeth Kennedy, aged 19, on 11 November 1883 in Cedarvale, Chauauqua, Kansas, USA at Chiurch of Crist. They had eleven children:
Sarah Elizabeth Kennaday³⁰⁷ in 1884
Rosa Marie Kennaday³⁰⁸ in 1886
Anna Ruth Kennaday³¹⁰ in 1888
Alonso Kennaday³¹² in 1889
Henry George Kennaday³¹³ in 1890
Harry Otis Kennaday³¹⁴ in 1892
Frank Forest Kennaday³¹⁶ in 1893
Edward Thomas Kennaday³¹⁸ in 1895
Alice Oda May Kennaday³²⁰ in 1897
Charles Fredrick Kennaday³²² in 1898
Emma Helen Kennaday³²⁴ in 1905
This family is shown as family tree 71.

331. JAMES EDWARD KENNADAY (James's grandson) was born on 15 July 1858 in Lexington, Mclean, Illinois, USA to John Hudson Kennaday³⁴⁰ and Anne Elizabeth Van Orsdel³⁴¹, as shown in family tree 73. James died on 6 June 1934, aged 75.
332. IDA JANE KENNADAY (James's granddaughter) was born on 4 April 1861 in Lexington, Mclean, Illinois, USA to John Hudson Kennaday³⁴⁰ and Anne Elizabeth Van Orsdel³⁴¹, as shown in family tree 73. Ida died on 5 April 1883, aged 22.
333. MARY V KENNADAY (James's granddaughter) was born on 12 January 1868 in Cherokee Nation, USA to John Hudson Kennaday³⁴⁰ and Anne Elizabeth Van Orsdel³⁴¹, as shown in family tree 73. Mary died on 4 October 1869, aged 1.
334. JOHN W KENNADAY (James's grandson) was born on 5 November 1870 in Springfield, Green, Missouri, USA to John Hudson Kennaday³⁴⁰ and Anne Elizabeth Van Orsdel³⁴¹, as shown in family tree 73. John died on 19 December 1958, aged 88.
335. ANNE E D KENNADAY (James's granddaughter) was born on 29 April 1875 in Lexington, Mclean, Illinois, USA to John Hudson Kennaday³⁴⁰ and Anne Elizabeth Van Orsdel³⁴¹, as shown in family tree 73. Anne died on 4 October 1960, aged 85.
336. EMMA H KENNADAY (James's granddaughter) was born on 10 September 1875 in Windfield, Cowley, Kansas, USA to John Hudson Kennaday³⁴⁰ and Anne Elizabeth Van Orsdel³⁴¹, as shown in family tree 73.
337. ANDREW JACKSON KENNADAY (James's grandson) was born on 15 July 1878 in Ceder Vale, Chautauqua, Kansas, USA to John Hudson Kennaday³⁴⁰ and Anne Elizabeth Van Orsdel³⁴¹, as shown in family tree 73. Andrew died on 8 December 1923, aged 45, in Saratoga, Carbon, Wyoming, USA.
Note: Brother To Frank. Kennady PK Named after him. At Wyoming Snowy Range.
338. ANNA MARSHEL (James's grandson's wife) was born in 1875. Anna died on 8 December 1960, aged about 85, in Saratoga, Carbon, Wyoming, USA.
 Andrew Jackson Kennaday³³⁷ married Anna Marshel. They had two children:
 Loyd Andrew Kennaday³²⁶ in 1903
 Fay Kennaday³²⁸ in 1907
This family is shown as family tree 72.

Generation of Children

339. JOSEPH BRYSON KENNADAY (James's son) was born on 22 February 1823 to James Kennaday³⁴⁸ and Sarah Hudson³⁴⁹, as shown in family tree 74. Joseph died on 20 May 1899, aged 76.
340. JOHN HUDSON KENNADAY (James's son) was born on 13 June 1825 to James Kennaday³⁴⁸ and Sarah Hudson³⁴⁹, as shown in family tree 74. John died on 8 November 1912, aged 87.
341. ANNE ELIZABETH VAN ORSDEL (James's daughter-in-law) was born on 1 August 1836 in Knox, Indiana, USA to Abram F Van Orsdel, Jr.⁵⁷⁰ and Rebecca K Boice⁵⁷¹. Anne died on 10 February 1916, aged 79, in Carbon, Wyoming, USA. She was buried in Kennaday Ranch.
 (Anne married twice. She was married to John Williams⁵⁵⁰ and John Hudson Kennaday³⁴⁰.)
[See also: Indirectly related via Anne Elizabeth Van Orsdel]
 John Hudson Kennaday³⁴⁰, aged 30, married Anne Elizabeth Van Orsdel, aged 19, on 30 August 1855 in Boone, Kentucky, USA. They had eight children:
 Charles Alonzo Kennaday³²⁹ in 1856
 James Edward Kennaday³³¹ in 1858
 Ida Jane Kennaday³³² in 1861
 Mary V Kennaday³³³ in 1868
 John W Kennaday³³⁴ in 1870
 Anne E D Kennaday³³⁵ in 1875
 Emma H Kennaday³³⁶ in 1875
 Andrew Jackson Kennaday³³⁷ in 1878
This family is shown as family tree 73.
342. ZARILDA KENNADAY (James's daughter) was born on 16 March 1828 to James Kennaday³⁴⁸ and Sarah Hudson³⁴⁹, as shown in family tree 74.
343. MARY VICKER KENNADAY (James's daughter) was born on 18 March 1834 to James Kennaday³⁴⁸ and Sarah Hudson³⁴⁹, as shown in family tree 74. Mary died on 18 February 1907, aged 72.

344. RACHEL A KENNADAY (James's daughter) was born to James Kennaday³⁴⁸ and Sarah Hudson³⁴⁹, as shown in family tree 74.
345. AXIE KENNADAY (James's daughter) was born to James Kennaday³⁴⁸ and Sarah Hudson³⁴⁹, as shown in family tree 74.
346. ALICE KENNADAY (James's daughter) was born to James Kennaday³⁴⁸ and Sarah Hudson³⁴⁹, as shown in family tree 74.
347. JOSEPH WRIGHT KENNADAY (James's son) was born to James Kennaday³⁴⁸ and Sarah Hudson³⁴⁹, as shown in family tree 74.

Generation of Peers

348. JAMES KENNADAY (The subject of this report) was born in Dublin, Ireland. James died on 5 May 1855.
349. SARAH HUDSON (James's wife).

James Kennaday³⁴⁸ married Sarah Hudson. They had eight children:

- Joseph Bryson Kennaday³³⁹ in 1823
- John Hudson Kennaday³⁴⁰ in 1825
- Zarilda Kennaday³⁴² in 1828
- Mary Vicker Kennaday³⁴³ in 1834
- Rachel A Kennaday³⁴⁴
- Axie Kennaday³⁴⁵
- Alice Kennaday³⁴⁶
- Joseph Wright Kennaday³⁴⁷

This family is shown as family tree 74.

5. INDIRECTLY RELATED via BETTY CAROL FITZPATRICK ¹⁵⁵
(James's Great-Great-Great-Grandson's wife)

Same generation as James's Five-Times-Great-Grandchildren

350. JAYDON UNKNOWN (Betty's great-nephew) was born to Brian Unknown³⁵⁹ and Jamie Christene Abner³⁵⁸.

Same generation as James's Four-Times-Great-Grandchildren

351. TERRI LYN FITZPATRICK (Betty's niece) was born to William Terry Fitzpatrick³⁶² and Linda D Shaw³⁶³.

352. TAMMY LYNN FITZPATRICK (Betty's niece) was born to William Terry Fitzpatrick³⁶² and Linda D Shaw³⁶³.

353. VIRGINIA RUTH FITZPATRICK (Betty's niece) was born to William Terry Fitzpatrick³⁶² and Linda D Shaw³⁶³.

354. A J FITZPATRICK (Betty's nephew) was born to William Terry Fitzpatrick³⁶² and Brenda Faye Mulberry³⁶⁴.

355. CANDICE MACHAEL WILLIAMS (Betty's niece) was born to Robert Therman Williams³⁶⁸ and Tempie Ann Fitzpatrick³⁶⁶.

356. CASEY BRANDENBURG (Betty's niece's husband).

Casey Brandenburg married Candice Machael Williams³⁵⁵.

357. RONALD LEE ABNER, JR. (Betty's nephew) was born to Ronald Lee Abner³⁶⁹ and Tempie Ann Fitzpatrick³⁶⁶.

358. JAMIE CHRISTENE ABNER (Betty's niece) was born to Ronald Lee Abner³⁶⁹ and Tempie Ann Fitzpatrick³⁶⁶.

359. BRIAN UNKNOWN (Betty's niece's husband).

Brian Unknown married Jamie Christene Abner³⁵⁸. They had one son:
Jaydon Unknown³⁵⁰

360. CHARLES RAYMOND THOMPSON, JR. (Betty's nephew) was born to Charles Raymond Thompson³⁷¹ and Sandra Darlene Fitzpatrick³⁷⁰.

361. DONNA DENICE THOMPSON (Betty's niece) was born on 6 January 1964 in Huntsville, Alabama, USA to Charles Raymond Thompson³⁷¹ and Sandra Darlene Fitzpatrick³⁷⁰. Donna died on 18 February 1964 as an infant, in Huntsville, Alabama, USA.

Same generation as James's Great-Great-Great-Grandchildren

362. WILLIAM TERRY FITZPATRICK (Betty's brother) was born to Edward S (Pete) Fitzpatrick³⁷² and Virginia Ruth Gulett³⁷⁴.

(William married three times. He was married to Linda D Shaw³⁶³, Brenda Faye Mulberry³⁶⁴ and Karen Unknown³⁶⁵.)

363. LINDA D SHAW (Betty's sister-in-law).

William Terry Fitzpatrick³⁶² married Linda D Shaw. They had three children:

Terri Lyn Fitzpatrick³⁵¹

Tammy Lynn Fitzpatrick³⁵²

Virginia Ruth Fitzpatrick³⁵³

364. BRENDA FAYE MULBERRY (Betty's sister-in-law).

William Terry Fitzpatrick³⁶² married Brenda Faye Mulberry. They had one son:

A J Fitzpatrick³⁵⁴

365. KAREN UNKNOWN (Betty's sister-in-law).

William Terry Fitzpatrick³⁶² married Karen Unknown.

366. TEMPIE ANN FITZPATRICK (Betty's sister) was born to Edward S (Pete) Fitzpatrick³⁷² and Virginia Ruth Gulett³⁷⁴.

(Tempie married three times. She was married to Johnny Glipsey³⁶⁷, Robert Therman Williams³⁶⁸ and Ronald Lee Abner³⁶⁹.)

367. JOHNNY GLIPSEY (Betty's brother-in-law).

Johnny Glipsey married Tempie Ann Fitzpatrick³⁶⁶.

368. ROBERT THERMAN WILLIAMS (Betty's brother-in-law). Robert died in 1990.

Robert Therman Williams married Tempie Ann Fitzpatrick³⁶⁶ on 27 November 1965. They had one daughter:

Candice Machael Williams³⁵⁵

369. RONALD LEE ABNER (Betty's brother-in-law).

Ronald Lee Abner married Tempie Ann Fitzpatrick³⁶⁶ on 4 July 1972. They had two children:

Ronald Lee Abner, Jr.³⁵⁷
 Jamie Christene Abner³⁵⁸

370. SANDRA DARLENE FITZPATRICK (Betty's sister) was born to Edward S (Pete) Fitzpatrick³⁷² and Virginia Ruth Gulett³⁷⁴.

371. CHARLES RAYMOND THOMPSON (Betty's brother-in-law).

Charles Raymond Thompson married Sandra Darlene Fitzpatrick³⁷⁰ in November 1963. They had two children:
 Charles Raymond Thompson, Jr.³⁶⁰
 Donna Denice Thompson³⁶¹ in 1964

Same generation as James's Great-Great-Grandchildren

372. EDWARD S (PETE) FITZPATRICK (Betty's father) was born on 8 July 1916 in Bourbon, Kentucky, USA to William Allen Fitzpatrick³⁷⁵ and Betty Jack Osburn³⁷⁶. Edward died on 8 November 1978, aged 62, in Bourbon, Kentucky, USA.

373. CECIL RAY MONTGOMERY (Betty's mother's husband).

Cecil married his indirect relation, Virginia Ruth Gulett³⁷⁴.

374. VIRGINIA RUTH GULETT (Betty's mother) was born on 23 February 1923 in Richmond, Kentucky, USA to Millard Gulett³⁷⁷ and Cora Elizabeth Hutchchison³⁷⁸. Virginia died on 21 January 2007, aged 83, in Holiday, Pasco, Florida, USA.

(Virginia married twice. She was married to Edward S (Pete) Fitzpatrick³⁷² and Cecil Ray Montgomery³⁷³.)

Edward S (Pete) Fitzpatrick³⁷² married Virginia Ruth Gulett. They had four children:

Betty Carol Fitzpatrick¹⁵⁵ in 1947

William Terry Fitzpatrick³⁶²

Tempie Ann Fitzpatrick³⁶⁶

Sandra Darlene Fitzpatrick³⁷⁰

Cecil Ray Montgomery³⁷³ married Virginia Ruth Gulett, aged 43, on 3 February 1967.

Same generation as James's Great-Grandchildren

375. WILLIAM ALLEN FITZPATRICK (Betty's grandfather) was born on 3 February 1887. William died on 12 March 1965, aged 78, in Northmiddle Town, Kentucky, USA.

376. BETTY JACK OSBURN (Betty's grandmother). Betty died in April 1961 in Northmiddle Town, Kentucky, USA.

William Allen Fitzpatrick³⁷⁵ married Betty Jack Osburn. They had one son:

Edward S (Pete) Fitzpatrick³⁷² in 1916

377. MILLARD GULETT (Betty's grandfather) was born on 11 August 1883 in Bretthett, Kentucky to John W Gulett³⁷⁹ and Cynthia Sizmoore³⁸⁰. Millard died on 8 March 1960, aged 76, in Harrisburg, Mercer, Kentucky, USA.

378. CORA ELIZABETH HUTCHCHISON (Betty's grandmother) was born on 29 September 1888 to Andy Hutchchison³⁸¹ and Lana Thomas³⁸².

Millard Gulett³⁷⁷ married Cora Elizabeth Hutchchison. They had one daughter:

Virginia Ruth Gulett³⁷⁴ in 1923

Same generation as James's Grandchildren

379. JOHN W GULETT (Betty's great-grandfather).

380. CYNTHIA SIZMOORE (Betty's great-grandmother).

John W Gulett³⁷⁹ married Cynthia Sizmoore. They had one son:

Millard Gulett³⁷⁷ in 1883

381. ANDY HUTCHCHISON (Betty's great-grandfather).

382. LANA THOMAS (Betty's great-grandmother).

Andy Hutchchison³⁸¹ married Lana Thomas. They had one daughter:

Cora Elizabeth Hutchchison³⁷⁸ in 1888

6. INDIRECTLY RELATED via JOHN DAVID KELLEY ²⁶²
(James's Great-Great-Granddaughter's husband)

Same generation as James's Four-Times-Great-Grandchildren

383. GARY SCOTT (John's great-nephew) was born on 3 January 1951 to Pete Scott⁴⁰⁸ and Dorthy Mae Kelley⁴⁰⁷.
384. DONNA SCOTT (John's great-niece) was born on 4 August 1959 to Pete Scott⁴⁰⁸ and Dorthy Mae Kelley⁴⁰⁷.
385. BOBBY GENE KELLEY (John's great-nephew) was born on 8 August 1954 in Carlisle, Kentucky, USA to Eugene Kelley⁴⁰⁹ and Opal Unknown⁴¹⁰.
386. CHARLES UNKNOWN (John's great-nephew) was born to Mr. Myers⁴¹³ and Juanita Kelley⁴¹¹.
387. CLARENCE UNKNOWN (John's great-nephew) was born to Mr. Myers⁴¹³ and Juanita Kelley⁴¹¹.
388. ELIZABETH FAYE UNKNOWN (John's great-niece) was born to Mr. Myers⁴¹³ and Juanita Kelley⁴¹¹.
389. HAROLED LEE PRUITT, JR. (John's great-nephew) was born to Harold Lee Pruitt⁴¹⁵ and Mary Elizabeth Kelley⁴¹⁴.
390. DANNY JAMES PRUITT (John's great-nephew) was born to Harold Lee Pruitt⁴¹⁵ and Mary Elizabeth Kelley⁴¹⁴.
391. RUTH ANN PRUITT (John's great-nephew) was born to Harold Lee Pruitt⁴¹⁵ and Mary Elizabeth Kelley⁴¹⁴.
392. CRISTINE MAE PRUITT (John's great-niece) was born to Harold Lee Pruitt⁴¹⁵ and Mary Elizabeth Kelley⁴¹⁴.
393. MICHAEL CAMERON PRUITT (John's great-nephew) was born to Harold Lee Pruitt⁴¹⁵ and Mary Elizabeth Kelley⁴¹⁴.
394. ALLEN TODD PRUITT (John's great-nephew) was born to Harold Lee Pruitt⁴¹⁵ and Mary Elizabeth Kelley⁴¹⁴.
395. ROSA E MARY BERRYMAN (John's great-niece) was born on 26 September 1959 to Tommy Berryman⁴¹⁷ and Wanda Lou Kelley⁴¹⁶.
396. GILBART BERRYMAN (John's great-nephew) was born on 20 April 1961 to Tommy Berryman⁴¹⁷ and Wanda Lou Kelley⁴¹⁶.
397. JULIE MAE BERRYMAN (John's great-niece) was born on 2 June 1962 to Tommy Berryman⁴¹⁷ and Wanda Lou Kelley⁴¹⁶. Julie died on 3 September 1963, aged 1.
398. FRED A JEAN BERRYMAN (John's great-niece) was born on 14 September 1963 to Tommy Berryman⁴¹⁷ and Wanda Lou Kelley⁴¹⁶.
399. TOMMY BERRYMAN, II (John's great-nephew) was born on 3 September 1964 to Tommy Berryman⁴¹⁷ and Wanda Lou Kelley⁴¹⁶.
400. BONNIE SUE UNKNOWN (John's great-niece) was born to Mr. Cox⁴²⁰ and Cristine Faye Kelley⁴¹⁸.
401. BILLY JOE UNKNOWN (John's great-nephew) was born to Mr. Cox⁴²⁰ and Cristine Faye Kelley⁴¹⁸.
402. JIMMY UNKNOWN (John's great-nephew) was born to Mr. Cox⁴²⁰ and Cristine Faye Kelley⁴¹⁸.
403. CHIP UNKNOWN (John's great-nephew) was born to Brenda Jane Kelley⁴²¹.
404. KIM UNKNOWN (John's great-niece) was born to Brenda Jane Kelley⁴²¹.
405. AMANDA KELLEY (John's great-niece) was born to Billy Dean Kelley⁴²⁵ and Ms. Unknown⁴²⁶.
406. BILLY DEAN KELLEY (John's great-nephew) was born to Billy Dean Kelley⁴²⁵ and Ms. Unknown⁴²⁶.

Same generation as James's Great-Great-Grandchildren

407. DORTHY MAE KELLEY (John's niece) was born on 3 December 1932 in Carlisle, Kentucky, USA to James Luther Kelley⁴³² and Cristine Sapp⁴³³.
408. PETE SCOTT (John's niece's husband).
Pete Scott married Dorothy Mae Kelley⁴⁰⁷. They had two children:
Gary Scott³⁸³ in 1951
Donna Scott³⁸⁴ in 1959
409. EUGENE KELLEY (John's nephew) was born on 25 April 1935 in Carlisle, Kentucky, USA to James Luther Kelley⁴³² and Cristine Sapp⁴³³.
410. OPAL UNKNOWN (John's nephew's wife).
Eugene Kelley⁴⁰⁹ married Opal Unknown. They had one son:
Bobby Gene Kelley³⁸⁵ in 1954
411. JUANITA KELLEY (John's niece) was born on 15 March 1937 in Carlisle, Kentucky, USA to James Luther Kelley⁴³² and Cristine Sapp⁴³³.
(Juanita married twice. She was married to Mr. Walton⁴¹² and Mr. Myers⁴¹³.)
412. MR. WALTON (John's niece's husband).
Mr. Walton married Juanita Kelley⁴¹¹.
413. MR. MYERS (John's niece's husband).
Mr. Myers married Juanita Kelley⁴¹¹. They had three children:
Charles Unknown³⁸⁶
Clarence Unknown³⁸⁷
Elizabeth Faye Unknown³⁸⁸
414. MARY ELIZABETH KELLEY (John's niece) was born on 2 January 1939 in Carlisle, Kentucky, USA to James Luther Kelley⁴³² and Cristine Sapp⁴³³.
415. HAROLD LEE PRUITT (John's niece's husband).
Harold Lee Pruitt married Mary Elizabeth Kelley⁴¹⁴. They had six children:
Harold Lee Pruitt, Jr.³⁸⁹
Danny James Pruitt³⁹⁰
Ruth Ann Pruitt³⁹¹
Cristine Mae Pruitt³⁹²
Michael Cameron Pruitt³⁹³
Allen Todd Pruitt³⁹⁴
416. WANDA LOU KELLEY (John's niece) was born on 22 February 1942 in Carlisle, Kentucky, USA to James Luther Kelley⁴³² and Cristine Sapp⁴³³.
417. TOMMY BERRYMAN (John's niece's husband).
Tommy Berryman married Wanda Lou Kelley⁴¹⁶. They had five children:
Rosa e Mary Berryman³⁹⁵ in 1959
Gilbart Berryman³⁹⁶ in 1961
Julie Mae Berryman³⁹⁷ in 1962
Freda Jean Berryman³⁹⁸ in 1963
Tommy Berryman, II³⁹⁹ in 1964
418. CRISTINE FAYE KELLEY (John's niece) was born on 9 December 1945 in Carlisle, Kentucky, USA to James Luther Kelley⁴³² and Cristine Sapp⁴³³.
(Cristine married twice. She was married to Mr. Treadway⁴¹⁹ and Mr. Cox⁴²⁰.)
419. MR. TREADWAY (John's niece's husband).
Mr. Treadway married Cristine Faye Kelley⁴¹⁸.
420. MR. COX (John's niece's husband).
Mr. Cox married Cristine Faye Kelley⁴¹⁸. They had three children:
Bonnie Sue Unknown⁴⁰⁰
Billy Joe Unknown⁴⁰¹
Jimmy Unknown⁴⁰²
421. BRENDA JANE KELLEY (John's niece) was born on 25 August 1951 in Carlisle, Kentucky, USA to James Luther Kelley⁴³² and Cristine Sapp⁴³³.
Brenda had two children:
Chip Unknown⁴⁰³
Kim Unknown⁴⁰⁴

422. JAMES LUTHER KELLEY, JR. (John's nephew) was born on 14 February 1953 in Carlisle, Kentucky, USA to James Luther Kelley⁴³² and Cristine Sapp⁴³³.
423. FREDDIE WARREN KELLEY (John's nephew) was born on 24 September 1954 in Carlisle, Kentucky, USA to James Luther Kelley⁴³² and Cristine Sapp⁴³³. Freddie died on 4 November 1956, aged 2, of Drowend, in Carlisle, Kentucky, USA.
424. DONNIE LEE KELLEY (John's nephew) was born on 25 November 1955 in Carlisle, Kentucky, USA to James Luther Kelley⁴³² and Cristine Sapp⁴³³.
425. BILLY DEAN KELLEY (John's nephew) was born on 9 June 1958 in Carlisle, Kentucky, USA to James Luther Kelley⁴³² and Cristine Sapp⁴³³.
426. MS. UNKNOWN (John's nephew's wife).
 Billy Dean Kelley⁴²⁵ married Ms. Unknown. They had two children:
 Amanda Kelley⁴⁰⁵
 Billy Dean Kelley⁴⁰⁶
427. WILLIAM BLAINE KELLEY (John's nephew) was born to Talmadge Blane Kelley, Jr.⁴³⁴ and Betty Earlywine⁴³⁵.
428. MILDRED ANN KELLEY (John's niece) was born to Talmadge Blane Kelley, Jr.⁴³⁴ and Betty Earlywine⁴³⁵.
429. AQUILLA DAVID KELLEY (John's nephew) was born to Talmadge Blane Kelley, Jr.⁴³⁴ and Betty Earlywine⁴³⁵.
430. MARY LOU KELLEY (John's niece) was born to Talmadge Blane Kelley, Jr.⁴³⁴ and Betty Earlywine⁴³⁵.
431. BEVERLY KELLEY (John's niece) was born to Talmadge Blane Kelley, Jr.⁴³⁴ and Betty Earlywine⁴³⁵.

Same generation as James's Great-Great-Grandchildren

432. JAMES LUTHER KELLEY (John's brother) was born on 31 March 1911 to Talmadge Blane Kelley⁴⁴² and Mary Elizabeth Minton⁴⁴³. James died on 27 March 1956, aged 44, in Carlisle, Kentucky, USA.
433. CRISTINE SAPP (John's sister-in-law) was born on 15 February 1919 to John Harvey Sapp⁵⁹⁶ and Mary Miranda Unknown⁵⁹⁷.
 [See also: *Indirectly related via Cristine Sapp*]
 James Luther Kelley⁴³², aged 21, married Cristine Sapp, aged 13, on 10 June 1932. They had eleven children:
 Dorothy Mae Kelley⁴⁰⁷ in 1932
 Eugene Kelley⁴⁰⁹ in 1935
 Juanita Kelley⁴¹¹ in 1937
 Mary Elizabeth Kelley⁴¹⁴ in 1939
 Wanda Lou Kelley⁴¹⁶ in 1942
 Cristine Faye Kelley⁴¹⁸ in 1945
 Brenda Jane Kelley⁴²¹ in 1951
 James Luther Kelley, Jr.⁴²² in 1953
 Freddie Warren Kelley⁴²³ in 1954
 Donnie Lee Kelley⁴²⁴ in 1955
 Billy Dean Kelley⁴²⁵ in 1958
434. TALMADGE BLANE KELLEY, JR. (John's brother) was born on 28 January 1917 to Talmadge Blane Kelley⁴⁴² and Mary Elizabeth Minton⁴⁴³.
435. BETTY EARLYWINE (John's sister-in-law) was born to Lou Kelley⁵⁹⁸.
 [See also: *Indirectly related via Betty Earlywine*]
 Talmadge Blane Kelley, Jr.⁴³⁴ married Betty Earlywine. They had five children:
 William Blaine Kelley⁴²⁷
 Mildred Ann Kelley⁴²⁸
 Aquilla David Kelley⁴²⁹
 Mary Lou Kelley⁴³⁰
 Beverly Kelley⁴³¹
436. AQUILLA DURHAM KELLEY (John's brother) was born to Talmadge Blane Kelley⁴⁴² and Mary Elizabeth Minton⁴⁴³.
437. EFRFIE MAE WATKINS (John's cousin) was born to Mr. Watkins⁴⁴⁸ and Mabel Kelley⁴⁴⁷.

438. RAYMOND SADLER (John's cousin) was born to Mr. Sadler⁴⁵⁸ and Carrie Minton⁴⁵⁷.
439. JAMES UNKNOWN (John's cousin) was born to Mr. Unknown⁴⁶¹ and Phillys Minton⁴⁶⁰.
440. EUGENE UNKNOWN (John's cousin) was born to Mr. Unknown⁴⁶¹ and Phillys Minton⁴⁶⁰.
441. BILL TOM UNKNOWN (John's cousin) was born to Mr. Unknown⁴⁶¹ and Phillys Minton⁴⁶⁰.

Same generation as James's Great-Grandchildren

442. TALMADGE BLANE KELLEY (John's father) was born on 12 July 1886 in Vandervill, Kentucky to Lewis Lute Kelley⁴⁶⁴ and Amelia Frances Bowles⁴⁶⁵. Talmadge died on 6 February 1931, aged 44.
 Note: *Tamalge & wife Mary moved in with Lewis on Mt. Merior Ridge and took care of him for a short time. (Between 1909-1911) Lewis then went from house to house, lived with his children.*
443. MARY ELIZABETH MINTON (John's mother) was born on 26 August 1876 in Old Virginia, Virginia to James M Minton⁴⁶⁶ and Margaret Johnson⁴⁶⁷. Mary died on 26 January 1961, aged 84, in Carlisle, Kentucky, USA.
 Talmadge Blane Kelley⁴⁴², aged 23, married Mary Elizabeth Minton, aged 33, on 16 December 1909. They had four children:
 James Luther Kelley⁴³² in 1911
 Talmadge Blane Kelley, Jr.⁴³⁴ in 1917
 John David Kelley²⁶² in 1917
 Aquilla Durham Kelley⁴³⁶
444. MILTON VARSO KELLEY (John's uncle) was born to Lewis Lute Kelley⁴⁶⁴ and Amelia Frances Bowles⁴⁶⁵.
445. HERBERT KELLEY (John's uncle) was born to Lewis Lute Kelley⁴⁶⁴ and Amelia Frances Bowles⁴⁶⁵.
446. HERMAN KELLEY (John's uncle) was born to Lewis Lute Kelley⁴⁶⁴ and Amelia Frances Bowles⁴⁶⁵.
447. MABEL KELLEY (John's aunt) was born to Lewis Lute Kelley⁴⁶⁴ and Amelia Frances Bowles⁴⁶⁵.
448. MR. WATKINS (John's uncle by marriage).
 Mr. Watkins married Mabel Kelley⁴⁴⁷. They had one daughter:
 Efrfie Mae Watkins⁴³⁷
449. BETTY JANE KELLEY (John's aunt) was born to Lewis Lute Kelley⁴⁶⁴ and Amelia Frances Bowles⁴⁶⁵.
450. SILVERINE KELLEY (John's aunt) was born to Lewis Lute Kelley⁴⁶⁴ and Amelia Frances Bowles⁴⁶⁵.
451. TONM MC RUTHER (John's uncle by marriage).
 Tonm Mc Ruther married Silverine Kelley⁴⁵⁰.
452. DELLA MINTON (John's aunt) was born on 26 February 1876 to James M Minton⁴⁶⁶ and Margaret Johnson⁴⁶⁷.
453. ISABELL MAY MINTON (John's aunt) was born on 15 May 1880 to James M Minton⁴⁶⁶ and Margaret Johnson⁴⁶⁷.
454. IDA CATHERINE MINTON (John's aunt) was born on 9 May 1882 to James M Minton⁴⁶⁶ and Margaret Johnson⁴⁶⁷.
455. JAMES MINTON (John's uncle) was born on 7 August 1884 to James M Minton⁴⁶⁶ and Margaret Johnson⁴⁶⁷.
456. MAGGIE MINTON (John's aunt) was born on 13 April 1886 to James M Minton⁴⁶⁶ and Margaret Johnson⁴⁶⁷.
457. CARRIE MINTON (John's aunt) was born on 7 June 1888 to James M Minton⁴⁶⁶ and Margaret Johnson⁴⁶⁷.
458. MR. SADLER (John's uncle by marriage).
 Mr. Sadler married Carrie Minton⁴⁵⁷. They had one son:
 Raymond Sadler⁴³⁸
459. ROSAYELLA MINTON (John's aunt) was born on 7 October 1890 to James M Minton⁴⁶⁶ and Margaret Johnson⁴⁶⁷.
460. PHILLYS MINTON (John's aunt) was born on 8 October 1892 to James M Minton⁴⁶⁶ and Margaret Johnson⁴⁶⁷.
461. MR. UNKNOWN (John's uncle by marriage).

Mr. Unknown married Phillys Minton⁴⁶⁰. They had three children:
 James Unknown⁴³⁹
 Eugene Unknown⁴⁴⁰
 Bill Tom Unknown⁴⁴¹

462. WALTER MINTON (John's uncle) was born on 12 August 1894 to James M Minton⁴⁶⁶ and Margaret Johnson⁴⁶⁷.
 Note: *Lived in Cynthiana, Kentucky had two daughters.*

463. ETHEL MINTON (John's aunt) was born on 1 June 1896 to James M Minton⁴⁶⁶ and Margaret Johnson⁴⁶⁷.

Same generation as James's Grandchildren

464. LEWIS LUTE KELLEY (John's grandfather) was born on 5 February 1863 in Nichlos, County, Kentucky to William S Kelley⁴⁶⁸ and Elizabeth Smith⁴⁶⁹. Lewis died on 25 July 1932, aged 69, in Ad Richeys home in Myers station.
 Note: *Lewis Kelley bought house on Mt Merior Ridge with insurance money from Son Herbert who was killed whe he fell from a telephone pole. and son Milton who was a world war vet who died in Dayton, Ohio Hospital neither son was ever married. Lewis walked with a cane. He had leg or legs broke in mill accident with logs. He never had his legs set by a doctor. Lewis's father left his mother (Elizabeth Smith) before Lewis was born never to be heard of again. Elizabeth later married amn named Sparks and had several childern. Lewis was raised with his half brothers and sisters.*

465. AMELIA FRANCES BOWLES (John's grandmother) was born on 20 June 1865.
 Lewis Lute Kelley⁴⁶⁴, aged 21, married Amelia Frances Bowles, aged 19, on 14 October 1884. They had seven children:

Talmadge Blane Kelley⁴⁴² in 1886
 Milton Varso Kelley⁴⁴⁴
 Herbert Kelley⁴⁴⁵
 Herman Kelley⁴⁴⁶
 Mabel Kelley⁴⁴⁷
 Betty Jane Kelley⁴⁴⁹
 Silverine Kelley⁴⁵⁰

466. JAMES M MINTON (John's grandfather) was born on 3 April 1851. James died on 23 October 1917, aged 66.
 Note: *James Minton and Margaret Johnson came from Russell Co. Virginia and were married in Tennessee. (information came from Ant Carrie Sadler taken out of her bible.*

467. MARGARET JOHNSON (John's grandmother) was born on 8 May 1856. Margaret died on 7 March 1938, aged 81.
 James M Minton⁴⁶⁶ married Margaret Johnson in Tennessee. They had eleven children:

Della Minton⁴⁵² in 1876
 Mary Elizabeth Minton⁴⁴³ in 1876
 Isabell May Minton⁴⁵³ in 1880
 Ida Catherine Minton⁴⁵⁴ in 1882
 James Minton⁴⁵⁵ in 1884
 Maggie Minton⁴⁵⁶ in 1886
 Carrie Minton⁴⁵⁷ in 1888
 Rosayella Minton⁴⁵⁹ in 1890
 Phillys Minton⁴⁶⁰ in 1892
 Walter Minton⁴⁶² in 1894
 Ethel Minton⁴⁶³ in 1896

Same generation as James's Children

468. WILLIAM S KELLEY (John's great-grandfather) was born to Erasmus E Kelley⁴⁷⁰ and Mary Mc Iwoan⁴⁷¹.

469. ELIZABETH SMITH (John's great-grandmother).

William S Kelley⁴⁶⁸ married Elizabeth Smith on 21 May 1870. They had one son:
 Lewis Lute Kelley⁴⁶⁴ in 1863

Same generation as James's Peers

470. ERAMUS E KELLEY (John's great-great-grandfather) was born to Edward Kelley⁴⁷² and America Mull⁴⁷³.

471. MARY MC IWOAN (John's great-great-grandmother).

Eramus E Kelley⁴⁷⁰ married Mary Mc Iwoan on 17 March 1856. They had one son:
William S Kelley⁴⁶⁸

Same generation as James's Parents

472. EDWARD KELLEY (John's great-great-great-grandfather).

Note: *Edward's brother wrote until Dec. 26, 1822. Was probated October term court in 1823. He left everything to his wife Eleanor except \$1.00 to each of his children his will did not mane any children.*

473. AMERICA MULL (John's great-great-great-grandmother).

Edward Kelley⁴⁷² married America Mull on 16 February 1834. They had one son:
Eramus E Kelley⁴⁷⁰

7. INDIRECTLY RELATED via BRUCE DOUGLAS WHITMAN²⁷⁶
(James's Great-Great-Granddaughter's husband)

Same generation as James's Great-Great-Great-Grandchildren

474. MARCUS PINE WHITMAN (Bruce's son) was born in 1962 to Bruce Douglas Whitman²⁷⁶ and Claudette Irene Corlett⁴⁷⁵.

Same generation as James's Great-Great-Great-Grandchildren

475. CLAUDETTE IRENE CORLETT (Bruce's wife).

Bruce Douglas Whitman²⁷⁶ married Claudette Irene Corlett. They had one son:
Marcus Pine Whitman⁴⁷⁴ in 1962

476. LORRAINE MADDEN (Bruce's wife).

Bruce Douglas Whitman²⁷⁶ married Lorraine Madden.

8. INDIRECTLY RELATED via MABLE PIERCE³¹⁷
(James's Great-Grandson's wife)

Same generation as James's Great-Grandchildren

477. ALICE PEARCE (Mable's sister) was born on 28 December 1893 in Denver, Colorado to Thomas Earl Pearce⁴⁷⁹ and Mary Adele Lambs- Cobb⁴⁸¹.

478. VIRGIE PHIPPS (Mable's half-sister) was born to James Phipps⁴⁸⁰ and Mary Adele Lambs- Cobb⁴⁸¹.

Same generation as James's Grandchildren

479. THOMAS EARL PEARCE (Mable's father) was born on 6 June 1858 in London, England. He became a Long Distance Runner.

Note: Thomas came to the United States when he was 20 as a long distance runner and he returned to England only once than came back to the United States and settled in Denver, Colorado, where he met Mary. They Thomas was fourteen years older than Mary. When their two girls were young they moved to Saratoga, Wyoming and homesteaded a piece of ground outside of Saratoga toward the Rocky Mountains. Thomas had a brother named Walter and a sister named Elizabeth (Lizzie)

All notes were prepared by: Florence Kennaday.

480. JAMES PHIPPS (Mable's mother's husband) was born in London, England.

James married his indirect relation, Mary Adele Lambs- Cobb⁴⁸¹.

481. MARY ADELE LAMBS- COBB (Mable's mother) was born on 24 September 1872 in Macon, Missouri.

(Mary married twice. She was married to Thomas Earl Pearce⁴⁷⁹ and James Phipps⁴⁸⁰.)

Note: Not sure which of the two Madin names was her real name and which was the name of the people that raised her. Her Mother was one half Cherokee indian and her father was a white man. She got married while she was in Missouri and in 1888 she again got married to James Phipps. She had two girls, Virgie and I don't know the name of the other girl. When the girls were small Mary, her sister Alice and her husband started for Colorado. They traveled by covered wagon and on the way the younger daughter was bitten by a tarantula and died. Mary and her sister Alice had to leave Missouri because a doctor had advised them to go to a higher and drier climate, as both of them had tuberculosis. Mary's sister finally died from the disease, but Mary lived into her 80's. Mary left Thomas and got custody of the girls, but when Thomas left Saratoga and stole the girls and moved back to Denver where he went to work and put them in an orphanage. I don't know when Mary finally got the girls back but they were eventually back together in Saratoga. While in Saratoga Mary had to earn a living so she became a Practical Nurse to support herself and her daughters.

All Notes were prepared by: Florence Kennaday.

Thomas Earl Pearce⁴⁷⁹ married Mary Adele Lambs- Cobb in Denver, Colorado. They had two children:

Alice Pearce⁴⁷⁷ in 1893

Mable Pierce³¹⁷ in 1897

James Phipps⁴⁸⁰ married Mary Adele Lambs- Cobb, aged about 15, in 1888. They had one daughter:

Virgie Phipps⁴⁷⁸

9. INDIRECTLY RELATED via FRANCES ELIZABETH KENNEDY ³³⁰
(James's Grandson's wife)

Same generation as James's Great-Grandchildren

482. MARCY KENNEDY (Frances's niece) was born to Alferd Shidler⁴⁹⁹ and Mariah Kennedy⁴⁹⁸.
483. EDDIE KENNEDY (Frances's nephew) was born to Alferd Shidler⁴⁹⁹ and Mariah Kennedy⁴⁹⁸.
484. ALVIN KENNEDY (Frances's nephew) was born to Alferd Shidler⁴⁹⁹ and Mariah Kennedy⁴⁹⁸.
485. BEARTHEY KENNEDY (Frances's nephew) was born to Alferd Shidler⁴⁹⁹ and Mariah Kennedy⁴⁹⁸.
486. WILLBER KENNEDY (Frances's nephew) was born to Alferd Shidler⁴⁹⁹ and Mariah Kennedy⁴⁹⁸.
487. ADDIE KENNEDY (Frances's niece) was born to Alferd Shidler⁴⁹⁹ and Mariah Kennedy⁴⁹⁸.
488. JESSE RUFUS KENNEDY (Frances's nephew) was born on 17 May 1885 in Ceder Vale, Chautauqua, Kansas, USA to John Ronnie Kennedy⁵⁰¹ and Nancy Alice Martindale⁵⁰².
489. FAY MCCLURE (Frances's nephew's wife).
Jesse Rufus Kennedy⁴⁸⁸, aged 24, married Fay McClure on 6 April 1910.
490. FREDRICK FAY KENNEDY (Frances's nephew) was born on 21 January 1888 in Ceder Vale, Chautauqua, Kansas, USA to John Ronnie Kennedy⁵⁰¹ and Nancy Alice Martindale⁵⁰². Fredrick died on 29 November 1908, aged 20.
491. SADIE BELL KENNEDY (Frances's niece) was born on 2 January 1890 in Ceder Vale, Chautauqua, Kansas, USA to John Ronnie Kennedy⁵⁰¹ and Nancy Alice Martindale⁵⁰². Sadie died on 5 December 1922, aged 32.
492. JAY MCCLURE (Frances's niece's husband).
Jay McClure married Sadie Bell Kennedy⁴⁹¹, aged 18, on 29 January 1908.
493. LILLIE IRENE KENNEDY (Frances's niece) was born on 4 May 1906 in Ceder Vale, Chautauqua, Kansas, USA to John Ronnie Kennedy⁵⁰¹ and Nancy Alice Martindale⁵⁰².
494. ELMER PERRY (Frances's niece's husband).
Elmer Perry married Lillie Irene Kennedy⁴⁹³.
495. CLARENCE BLAND KENNEDY (Frances's nephew) was born on 9 April 1980 in Ceder Vale, Chautauqua, Kansas, USA to John Ronnie Kennedy⁵⁰¹ and Nancy Alice Martindale⁵⁰².
496. ALICE UNKNOWN (Frances's nephew's wife).
Clarence Bland Kennedy⁴⁹⁵ married Alice Unknown.

Same generation as James's Grandchildren

497. EMALINE KENNEDY (Frances's sister) was born on 25 October 1852 to Jesse Rufus Kennedy⁵¹⁴ and Sarah Ann Ankrom⁵¹⁵. Emaline died on 27 February 1860, aged 7.
498. MARIAH KENNEDY (Frances's sister) was born on 13 March 1854 to Jesse Rufus Kennedy⁵¹⁴ and Sarah Ann Ankrom⁵¹⁵. Mariah died on 14 November 1911, aged 57.
499. ALFERD SHIDLER (Frances's brother-in-law).
Alferd Shidler married Mariah Kennedy⁴⁹⁸, aged 23, on 20 August 1877. They had six children:
Marcy Kennedy⁴⁸²
Eddie Kennedy⁴⁸³
Alvin Kennedy⁴⁸⁴
Bearthey Kennedy⁴⁸⁵
Willber Kennedy⁴⁸⁶
Addie Kennedy⁴⁸⁷
500. NANCH ISABELL KENNEDY (Frances's sister) was born on 25 December 1855 to Jesse Rufus Kennedy⁵¹⁴ and Sarah Ann Ankrom⁵¹⁵. Nanch died in March 1860, aged 4.
501. JOHN RONNIE KENNEDY (Frances's brother) was born on 26 December 1857 in Vinton, Ohio, USA to Jesse Rufus Kennedy⁵¹⁴ and Sarah Ann Ankrom⁵¹⁵. John died on 20 January 1926, aged 68.
502. NANCY ALICE MARTINDALE (Frances's sister-in-law) was born on 2 November 1864. Nancy died on 27 August 1952, aged 87, in Polk, Missouri, USA.
John Ronnie Kennedy⁵⁰¹, aged 24, married Nancy Alice Martindale, aged 17, on 6 September 1882. They had five children:

Jesse Rufus Kennedy⁴⁸⁸ in 1885
 Fredrick Fay Kennedy⁴⁹⁰ in 1888
 Sadie Bell Kennedy⁴⁹¹ in 1890
 Lillie Irene Kennedy⁴⁹³ in 1906
 Clarence Bland Kennedy⁴⁹⁵ in 1980

503. ANDREW KENNEDY (Frances's brother) was born on 20 August 1860 in Vinton, Ohio, USA to Jesse Rufus Kennedy⁵¹⁴ and Sarah Ann Ankrom⁵¹⁵. Andrew died on 12 September 1929, aged 69.
504. EFFIE BACUS (Frances's sister-in-law).
 Andrew Kennedy⁵⁰³, aged 21, married Effie Bacus on 9 May 1882.
505. SAMUEL RUFUS KENNEDY (Frances's brother) was born on 24 October 1862 to Jesse Rufus Kennedy⁵¹⁴ and Sarah Ann Ankrom⁵¹⁵. Samuel died on 29 January 1896, aged 33.
506. LILLIE TREDWAY (Frances's sister-in-law).
 Samuel Rufus Kennedy⁵⁰⁵, aged 23, married Lillie Tredway on 8 July 1886.
507. JAMES FRANKLIN KENNEDY (Frances's brother) was born on 15 November 1866 in Boody, Macon, Illinois to Jesse Rufus Kennedy⁵¹⁴ and Sarah Ann Ankrom⁵¹⁵. James died on 21 January 1918, aged 51.
508. LOUISE WHITED (Frances's sister-in-law).
 James Franklin Kennedy⁵⁰⁷, aged 32, married Louise Whited on 11 March 1899.
509. WILLIAM EDSON KENNEDY (Frances's brother) was born on 15 October 1868 in Boody, Macon, Illinois to Jesse Rufus Kennedy⁵¹⁴ and Sarah Ann Ankrom⁵¹⁵. William died on 12 March 1889, aged 20.
510. GEORGE WASHINGTON KENNEDY (Frances's brother) was born on 11 October 1870 in Ceder Vale, Chautauqua, Kansas, USA to Jesse Rufus Kennedy⁵¹⁴ and Sarah Ann Ankrom⁵¹⁵. George died on 30 March 1931, aged 60.
511. MARY ELIZABETH SKELTON (Frances's sister-in-law) was born on 14 August 1863 in Seligman, Barry, Missouri, USA to James Franklin Skelton⁵⁸⁹ and Mary Jane Unknown⁵⁹⁰.
[See also: Indirectly related via Mary Elizabeth Skelton]
 George Washington Kennedy⁵¹⁰, aged 18, married Mary Elizabeth Skelton, aged 25, on 7 April 1889 in Missouri, USA.
512. SARAH JANE KENNEDY (Frances's sister) was born on 11 December 1872 in Ceder Vale, Chautauqua, Kansas, USA to Jesse Rufus Kennedy⁵¹⁴ and Sarah Ann Ankrom⁵¹⁵. Sarah died on 20 March 1880, aged 7.
513. JESSE WIRTZ (Frances's sister) was born to Jesse Rufus Kennedy⁵¹⁴ and Sarah Ann Ankrom⁵¹⁵.
 Note: *Jesse was raised from infant. And was daughter of Kennaday and Ida Jane Wirts.*

Same generation as James's Children

514. JESSE RUFUS KENNEDY (Frances's father) was born on 2 March 1831 in Gurnsey, Ohio, USA to John Kennedy⁵⁴⁰ and Sarah Jane Raynor⁵⁴¹. He became a Pioneer Farmer. Jesse died on 7 August 1899, aged 68, in Ceder Vale, Chautauqua, Kansas, USA.
515. SARAH ANN ANKROM (Frances's mother) was born on 12 September 1830 in Green, Pennsylvania, USA to John Ankrom⁵⁴² and Ruth Unknown⁵⁴³. Sarah died on 29 March 1920, aged 89, in Ceder Vale, Chautauqua, Kansas, USA.
 Jesse Rufus Kennedy⁵¹⁴, aged 20, married Sarah Ann Ankrom, aged 21, on 11 December 1851 in Ohio. They had twelve children:
 Emaline Kennedy⁴⁹⁷ in 1852
 Mariah Kennedy⁴⁹⁸ in 1854
 Nanch Isabell Kennedy⁵⁰⁰ in 1855
 John Ronnie Kennedy⁵⁰¹ in 1857
 Andrew Kennedy⁵⁰³ in 1860
 Samuel Rufus Kennedy⁵⁰⁵ in 1862
 Frances Elizabeth Kennedy³³⁰ in 1864
 James Franklin Kennedy⁵⁰⁷ in 1866
 William Edson Kennedy⁵⁰⁹ in 1868
 George Washington Kennedy⁵¹⁰ in 1870
 Sarah Jane Kennedy⁵¹² in 1872
 Jesse Wirtz⁵¹³
516. NANCY KENNEDY (Frances's aunt) was born on 1 January 1821 in Wanesburg, Green, Pennsylvania, USA to John Kennedy⁵⁴⁰ and Sarah Jane Raynor⁵⁴¹. Nancy died in 1901, aged about 80.

517. BENJAMIN KIRK SHEPHERD (Frances's uncle by marriage).
Benjamin Kirk Shepherd married Nancy Kennedy⁵¹⁶, aged 21, on 29 December 1842.
518. CHRISTINE KENNEDY (Frances's aunt) was born on 11 July 1822 in Wanesburg, Green, Pennsylvania, USA to John Kennedy⁵⁴⁰ and Sarah Jane Raynor⁵⁴¹.
519. JACOB KENNEDY (Frances's uncle) was born on 10 November 1826 in Wanyesburg, Green, Pennsylvania USA to John Kennedy⁵⁴⁰ and Sarah Jane Raynor⁵⁴¹.
520. JAMES LEIGHTON KENNEDY (Frances's uncle) was born on 10 November 1826 in Waynesburg, Green, Pennsylvania USA to John Kennedy⁵⁴⁰ and Sarah Jane Raynor⁵⁴¹. James died on 19 March 1875, aged 48.
521. ELIZABETH RHINEHEART (Frances's aunt by marriage). Elizabeth died on 19 March 1875.
James Leighton Kennedy⁵²⁰ married Elizabeth Rhineheart.
522. JONN KENNEDY (Frances's uncle) was born on 19 June 1833 in Vinton, Ohio, USA to John Kennedy⁵⁴⁰ and Sarah Jane Raynor⁵⁴¹.
523. LYDIA JARVIS (Frances's aunt by marriage).
Jonn Kennedy⁵²², aged 28, married Lydia Jarvis on 6 October 1861 in Nobel.
524. EMILINE KENNEDY (Frances's aunt) was born on 9 January 1836 in Noble, Ohio, USA to John Kennedy⁵⁴⁰ and Sarah Jane Raynor⁵⁴¹. Emiline died on 19 May 1923, aged 87.
525. SAMUEL KENNEDY (Frances's uncle) was born on 28 February 1837 in Zaleski, Vinton, Ohio, USA to John Kennedy⁵⁴⁰ and Sarah Jane Raynor⁵⁴¹.
526. SARAH JANE KENNEDY (Frances's aunt) was born on 16 June 1840 in Zaleski, Vinton, Ohio, USA to John Kennedy⁵⁴⁰ and Sarah Jane Raynor⁵⁴¹.
527. ELIZABETH KENNEDY (Frances's aunt) was born on 16 June 1842 to John Kennedy⁵⁴⁰ and Sarah Jane Raynor⁵⁴¹.
528. REBECCA KENNEDY (Frances's aunt) was born on 9 April 1845 in Vinton, Ohio, USA to John Kennedy⁵⁴⁰ and Sarah Jane Raynor⁵⁴¹. Rebecca died on 1 January 1882, aged 36.
529. RICHARD ANKROM (Frances's uncle) was born on 5 February 1827 in Green, Pennsylvania, USA to John Ankrom⁵⁴² and Ruth Unknown⁵⁴³.
530. SOLOMON ANKROM (Frances's uncle) was born on 8 August 1828 in Green, Pennsylvania, USA to John Ankrom⁵⁴² and Ruth Unknown⁵⁴³. Solomon died on 2 June 1850, aged 21.
531. JOHN ELLERY ANKROM (Frances's uncle) was born on 2 June 1833 in Green, Pennsylvania, USA to John Ankrom⁵⁴² and Ruth Unknown⁵⁴³. John died on 14 June 1850, aged 17.
532. MARY ANN ANKROM (Frances's aunt) was born on 14 July 1835 to John Ankrom⁵⁴² and Ruth Unknown⁵⁴³.
533. MARTHA ANN ANKROM (Frances's aunt) was born on 4 November 1837 in Green, Pennsylvania, USA to John Ankrom⁵⁴² and Ruth Unknown⁵⁴³. Martha died on 24 June 1855, aged 17.
534. WILLIAM ANKROM (Frances's uncle) was born on 7 April 1840 in Green, Pennsylvania, USA to John Ankrom⁵⁴² and Ruth Unknown⁵⁴³.
535. URIAH ANKROM (Frances's uncle) was born on 29 May 1842 in Green, Pennsylvania, USA to John Ankrom⁵⁴² and Ruth Unknown⁵⁴³. Uriah died on 3 March 1860, aged 17.
536. ELIZABETH ANKROM (Frances's aunt) was born on 27 June 1844 in Green, Pennsylvania, USA to John Ankrom⁵⁴² and Ruth Unknown⁵⁴³.
537. MIRIAH ANKROM (Frances's aunt) was born on 28 December 1846 in Green, Pennsylvania, USA to John Ankrom⁵⁴² and Ruth Unknown⁵⁴³.
538. CLEMENTINE ANKROM (Frances's aunt) was born on 21 November 1848 in Green, Pennsylvania, USA to John Ankrom⁵⁴² and Ruth Unknown⁵⁴³. Clementine died on 8 April 1866, aged 17.

539. THOMAS ANKROM (Frances's uncle) was born on 1 May 1853 in Green, Pennsylvania, USA to John Ankrom⁵⁴² and Ruth Unknown⁵⁴³.

Same generation as James's Peers

540. JOHN KENNEDY (Frances's grandfather) was born on 9 January 1795 in Dublin, Ireland to William Kennedy⁵⁴⁴. He became a Farmer, Soldier in war of 1812. John died on 10 August 1865, aged 70, in JacksoTownsh, Ohio, USA.

541. SARAH JANE RAYNOR (Frances's grandmother) was born on 10 October 1797 in Waynesburg, Green, Pennsylvania USA to Jake Raynor⁵⁴⁵. Sarah died on 8 April 1888, aged 90.

John Kennedy⁵⁴⁰, aged about 23, married Sarah Jane Raynor, aged about 20, in 1818. They had eleven children:

- Nancy Kennedy⁵¹⁶ in 1821
- Christine Kennedy⁵¹⁸ in 1822
- Jacob Kennedy⁵¹⁹ in 1826
- James Leighton Kennedy⁵²⁰ in 1826
- Jesse Rufus Kennedy⁵¹⁴ in 1831
- Jonn Kennedy⁵²² in 1833
- Emiline Kennedy⁵²⁴ in 1836
- Samuel Kennedy⁵²⁵ in 1837
- Sarah Jane Kennedy⁵²⁶ in 1840
- Elizabeth Kennedy⁵²⁷ in 1842
- Rebecca Kennedy⁵²⁸ in 1845

542. JOHN ANKROM (Frances's grandfather) was born on 9 August 1809 in Green, Pennsylvania, USA to William Ankrom⁵⁴⁶ and Mary Egor⁵⁴⁷. John died on 12 May 1887, aged 77.

543. RUTH UNKNOWN (Frances's grandmother) was born on 2 April 1807 to Joseph Ankrom⁵⁴⁸ and Elizabeth Sellers⁵⁴⁹.

John Ankrom⁵⁴², aged 16, married Ruth Unknown, aged 19, on 7 May 1826. They had twelve children:

- Richard Ankrom⁵²⁹ in 1827
- Solomon Ankrom⁵³⁰ in 1828
- Sarah Ann Ankrom⁵¹⁵ in 1830
- John Ellery Ankrom⁵³¹ in 1833
- Mary Ann Ankrom⁵³² in 1835
- Martha Ann Ankrom⁵³³ in 1837
- William Ankrom⁵³⁴ in 1840
- Uriah Ankrom⁵³⁵ in 1842
- Elizabeth Ankrom⁵³⁶ in 1844
- Miriah Ankrom⁵³⁷ in 1846
- Clementine Ankrom⁵³⁸ in 1848
- Thomas Ankrom⁵³⁹ in 1853

Same generation as James's Parents

544. WILLIAM KENNEDY (Frances's great-grandfather).

William fathered one son:

- John Kennedy⁵⁴⁰ in 1795

545. JAKE RAYNOR (Frances's great-grandfather).

Jake fathered one daughter:

- Sarah Jane Raynor⁵⁴¹ in 1797

546. WILLIAM ANKROM (Frances's great-grandfather).

547. MARY EAGOR (Frances's great-grandmother).

William Ankrom⁵⁴⁶ married Mary Egor. They had one son:

- John Ankrom⁵⁴² in 1809

548. JOSEPH ANKROM (Frances's great-grandfather).

549. ELIZABETH SELLERS (Frances's great-grandmother).

Joseph Ankrom⁵⁴⁸ married Elizabeth Sellers. They had one daughter:

- Ruth Unknown⁵⁴³ in 1807

10. INDIRECTLY RELATED via ANNE ELIZABETH VAN ORSDEL³⁴¹
(James's Daughter-in-law)

Same generation as James's Children

550. JOHN WILLIAMS (Anne's husband).
John Williams married Anne Elizabeth Van Orsdel³⁴¹.
551. WILLIAM GEORGE VAN ORSDEL (Anne's brother) was born on 15 December 1827 in Harrisburg, Mercer, Kentucky, USA to Abram F Van Orsdel, Jr.⁵⁷⁰ and Rebecca K Boice⁵⁷¹. William died on 19 February 1863, aged 35.
552. SARAH CATTERSON (Anne's sister-in-law).
William George Van Orsdel⁵⁵¹, aged 23, married Sarah Catterson on 22 February 1851.
553. JAMES H VAN ORSDEL (Anne's brother) was born on 11 February 1830 in Knox, Indiana, USA to Abram F Van Orsdel, Jr.⁵⁷⁰ and Rebecca K Boice⁵⁷¹.
554. SALLIE MATOXX (Anne's sister-in-law).
James H Van Orsdel⁵⁵³, aged 24, married Sallie Matoxx on 22 July 1854.
555. MARY B VAN ORSDEL (Anne's sister) was born on 21 June 1834 in Knox, Indiana, USA to Abram F Van Orsdel, Jr.⁵⁷⁰ and Rebecca K Boice⁵⁷¹. Mary died on 11 March 1914, aged 79.
556. REUBIN THORNHELL (Anne's brother-in-law).
Reubin Thornhell married Mary B Van Orsdel⁵⁵⁵.
557. REBECCA ELLEN VAN ORSDEL (Anne's sister) was born on 24 February 1839 in Lexington, Fayette, Kentucky, USA to Abram F Van Orsdel, Jr.⁵⁷⁰ and Rebecca K Boice⁵⁷¹. Rebecca died on 18 January 1921, aged 81.
558. WILLIAM B HEWITT (Anne's brother-in-law).
William B Hewitt married Rebecca Ellen Van Orsdel⁵⁵⁷, aged 20, on 13 February 1860.
559. MELINDA CATHERINE VAN ORSDEL (Anne's sister) was born on 14 October 1841 in Lexington, Fayette, Kentucky, USA to Abram F Van Orsdel, Jr.⁵⁷⁰ and Rebecca K Boice⁵⁷¹. Melinda died on 6 June 1934, aged 92.
560. JOHN BENJAMIN POLLARD (Anne's brother-in-law).
John Benjamin Pollard married Melinda Catherine Van Orsdel⁵⁵⁹, aged 20, on 31 December 1861.
561. SARAH E VAN ORSDEL (Anne's sister) was born on 31 August 1843 in Cynthiana, Scott, Kentucky, USA to Abram F Van Orsdel, Jr.⁵⁷⁰ and Rebecca K Boice⁵⁷¹. Sarah died on 27 February 1895, aged 51.
(Sarah married twice. She was married to Thomas Rogers⁵⁶² and Noah Diehl⁵⁶³.)
562. THOMAS ROGERS (Anne's brother-in-law).
Thomas Rogers married Sarah E Van Orsdel⁵⁶¹, aged 24, on 3 July 1868.
563. NOAH DIEHL (Anne's brother-in-law).
Noah Diehl married Sarah E Van Orsdel⁵⁶¹, aged 44, on 13 June 1888.
564. ABRAM VAN ORSDEL (Anne's brother) was born on 31 December 1845 in Bourbon, Kentucky, USA to Abram F Van Orsdel, Jr.⁵⁷⁰ and Rebecca K Boice⁵⁷¹. Abram died on 4 January 1846 as an infant.
565. ISABELL VAN ORSDEL (Anne's sister) was born on 1 December 1846 in Cynthiana, Scott, Kentucky, USA to Abram F Van Orsdel, Jr.⁵⁷⁰ and Rebecca K Boice⁵⁷¹. Isabell died on 24 March 1890, aged 43.
566. JAMES H WALLACE (Anne's brother-in-law).
James H Wallace married Isabell Van Orsdel⁵⁶⁵, aged 20, on 25 December 1866.
567. HENERY GEORGE VAN ORSDEL (Anne's brother) was born on 17 June 1849 in Owen, Kentucky, USA to Abram F Van Orsdel, Jr.⁵⁷⁰ and Rebecca K Boice⁵⁷¹.
(Henry married twice. He was married to Annie E Mitchell⁵⁶⁸ and Mattie Anderson⁵⁶⁹.)
568. ANNIE E MITCHELL (Anne's sister-in-law).
Henry George Van Orsdel⁵⁶⁷, aged about 17, married Annie E Mitchell in 1866.
569. MATTIE ANDERSON (Anne's sister-in-law).
Henry George Van Orsdel⁵⁶⁷, aged about 28, married Mattie Anderson in 1877.

Same generation as James's Peers

570. ABRAM F VAN ORSDEL, JR. (Anne's father) was born in 1808 to Abram Van Orsdel Van Orsdel⁵⁸⁴ and Ellen Unknown⁵⁸⁵. Abram died in 1849, aged about 41.
571. REBECCA K BOICE (Anne's mother) was born on 16 April 1810 in Harrisburg, Mercer, Kentucky, USA to Ephriam Boice⁵⁸⁶ and Mary Vicker Smock⁵⁸⁷. Rebecca died on 6 April 1900, aged 89, in Clay, City Powel, Kentucky, USA. Abram F Van Orsdel, Jr.⁵⁷⁰, aged about 18, married Rebecca K Boice, aged 16, on 27 February 1827. They had ten children:
- William George Van Orsdel⁵⁵¹ in 1827
 - James H Van Orsdel⁵⁵³ in 1830
 - Mary B Van Orsdel⁵⁵⁵ in 1834
 - Anne Elizabeth Van Orsdel³⁴¹ in 1836
 - Rebecca Ellen Van Orsdel⁵⁵⁷ in 1839
 - Melinda Catherine Van Orsdel⁵⁵⁹ in 1841
 - Sarah E Van Orsdel⁵⁶¹ in 1843
 - Abram Van Orsdel⁵⁶⁴ in 1845
 - Isabell Van Orsdel⁵⁶⁵ in 1846
 - Henery George Van Orsdel⁵⁶⁷ in 1849
572. MARY B BOICE (Anne's aunt) was born to Ephriam Boice⁵⁸⁶ and Mary Vicker Smock⁵⁸⁷.
573. GIDEON WOOD (Anne's uncle by marriage).
Gideon Wood married Mary B Boice⁵⁷² in 1820 in Harrisburg, Mercer, Kentucky, USA.
574. KATIE BOICE (Anne's aunt) was born in Harrisburg, Mercer, Kentucky, USA to Ephriam Boice⁵⁸⁶ and Mary Vicker Smock⁵⁸⁷.
575. SAMUEL RYNEARSON (Anne's uncle by marriage).
Samuel Rynearson married Katie Boice⁵⁷⁴.
576. JACOB BOICE (Anne's uncle) was born in Harrisburg, Mercer, Kentucky, USA to Ephriam Boice⁵⁸⁶ and Mary Vicker Smock⁵⁸⁷.
577. JANE VAN ORSEDEL (Anne's aunt by marriage).
Jacob Boice⁵⁷⁶ married Jane Van Orsdel.
578. GEORGE SCOMP (Anne's uncle) was born to Jacob Scomp⁵⁸⁸ and Mary Vicker Smock⁵⁸⁷.
579. JOHN SCOMP (Anne's uncle) was born to Jacob Scomp⁵⁸⁸ and Mary Vicker Smock⁵⁸⁷.
580. HENRY SCOMP (Anne's uncle) was born to Jacob Scomp⁵⁸⁸ and Mary Vicker Smock⁵⁸⁷.
581. ANNIE E SCOMP (Anne's aunt) was born to Jacob Scomp⁵⁸⁸ and Mary Vicker Smock⁵⁸⁷.
582. SALLY SCOMP (Anne's aunt) was born to Jacob Scomp⁵⁸⁸ and Mary Vicker Smock⁵⁸⁷.
583. HANNA SCOMP (Anne's aunt) was born to Jacob Scomp⁵⁸⁸ and Mary Vicker Smock⁵⁸⁷.

Same generation as James's Parents

584. ABRAM VAN ORSDEL VAN ORSDEL (Anne's grandfather).
585. ELLEN UNKNOWN (Anne's grandmother).
Abram Van Orsdel Van Orsdel⁵⁸⁴ married Ellen Unknown. They had one son:
Abram F Van Orsdel, Jr.⁵⁷⁰ in 1808
586. EPHRIAM BOICE (Anne's grandfather).
587. MARY VICKER SMOCK (Anne's grandmother).
(Mary married twice. She was married to Ephriam Boice⁵⁸⁶ and Jacob Scomp⁵⁸⁸.)
Ephriam Boice⁵⁸⁶ married Mary Vicker Smock. They had four children:
Rebecca K Boice⁵⁷¹ in 1810
Mary B Boice⁵⁷²
Katie Boice⁵⁷⁴
Jacob Boice⁵⁷⁶
588. JACOB SCOMP (Anne's grandmother's husband) was born in New Jersey, USA.

Jacob Scomp married Mary Vicker Smock⁵⁸⁷. They had six children:

- George Scomp⁵⁷⁸
- John Scomp⁵⁷⁹
- Henry Scomp⁵⁸⁰
- Annie E Scomp⁵⁸¹
- Sally Scomp⁵⁸²
- Hanna Scomp⁵⁸³

11. INDIRECTLY RELATED via MARY ELIZABETH SKELTON⁵¹¹
(Frances Elizabeth Kennedy's Sister-in-law)

Same generation as James's Children

589. JAMES FRANKLIN SKELTON (Mary's father).

590. MARY JANE UNKNOWN (Mary's mother).

James Franklin Skelton⁵⁸⁹ married Mary Jane Unknown. They had one daughter:
Mary Elizabeth Skelton⁵¹¹ in 1863

12. INDIRECTLY RELATED via CRISTINE SAPP⁴³³
(John David Kelley's Sister-in-law)

Same generation as James's Great-Great-Grandchildren

591. EVERETT SAPP (Cristine's brother) was born to John Harvey Sapp⁵⁹⁶ and Mary Miranda Unknown⁵⁹⁷.
592. LIZZIE SAPP (Cristine's sister) was born to John Harvey Sapp⁵⁹⁶ and Mary Miranda Unknown⁵⁹⁷.
593. ARCHIE SAPP (Cristine's brother) was born to John Harvey Sapp⁵⁹⁶ and Mary Miranda Unknown⁵⁹⁷.
594. ROY SAPP (Cristine's brother) was born to John Harvey Sapp⁵⁹⁶ and Mary Miranda Unknown⁵⁹⁷.
595. CLARA BELLE SAPP (Cristine's sister) was born to John Harvey Sapp⁵⁹⁶ and Mary Miranda Unknown⁵⁹⁷.

Same generation as James's Great-Grandchildren

596. JOHN HARVEY SAPP (Cristine's father). John died on 18 December 1958.
597. MARY MIRANDA UNKNOWN (Cristine's mother). Mary died in 1946.
John Harvey Sapp⁵⁹⁶ married Mary Miranda Unknown. They had six children:
Cristine Sapp⁴³³ in 1919
Everett Sapp⁵⁹¹
Lizzie Sapp⁵⁹²
Archie Sapp⁵⁹³
Roy Sapp⁵⁹⁴
Clara Belle Sapp⁵⁹⁵

13. INDIRECTLY RELATED via BETTY EARLYWINE⁴³⁵
(John David Kelley's Sister-in-law)

Same generation as James's Great-Grandchildren

598. LOU KELLEY (Betty's mother).

Lou Kelley was married. She had one daughter:

Betty Earlywine⁴³⁵

14. FAMILY TREES

The following family trees each show the reported children, parents, grandparents and great-grandparents of a family group. In order to reduce redundancy, any family group which is wholly included within another family tree may not be reported separately.

Above each of the great-grandparent boxes (top row), a continuation family tree reference number in angle brackets is shown if the great-grandparent is recorded as a child in the continuation tree. A continuation reference number is also shown to the left of a grandparent or parent box if that individual has siblings reported in the continuation tree; and beneath a child box (bottom row) if that individual has children reported in the continuation tree.

In cases of multiple marriages, a continuation reference number preceded by "=" is shown to the right of a parent box. This number references the previous and/or next tree in which that individual is shown with another partner.

1. BOYD, James Vencent & SOBO, Brenda Sue
2. SOBO, Randy Eugene & JOHNSON, Kim Eileen
3. KENNADAY, Todd & JORGENSEN, Joyce Ellen
4. HUNNICUTT, Cristian & KELLEY, Lisa June
5. ASBURY, James Mickel & KELLEY, Lisa June
6. MEYER, Mark & JONES, Sherrie (Like a Daughter)
7. LETT, Tim & CURTIS, Anita Carol
8. CURTIS, David Earl & BENNER, Toni
9. SOBO, Cornell Alexander, Jr. & KENNADAY, Charlotte Arlene
10. KENNADAY, Thomas Eugene & BENSON, Janice
11. GEPPERT, August Henry & KENNADAY, Patty Ray
12. RAMSEY, Earl Efton (Butch) & HUBBARD, Rosa L
13. HAYES, Bob & RAMSEY, Afton Ernstine (Marier)
14. KENNADAY, Jack Wayne & BRANT, Carol Lee
15. KENNADAY, Gary Forrest & THOMPSON, Alice
16. KENNADAY, Michael Joseph & WILLIAMS, Carolyn
17. LOTT, Jimmy Ray & DOLLAR HYDE, Ellen
18. BLUNT, Al & LOTT, Rosa Lee
19. LOTT, Calvin Jay & STURGESS, Jo Ann
20. SLOANE, Mr. & LOTT, Mable Bea
21. KELLEY, Ronald David, Sr. & FITZPATRICK, Betty Carol
22. CURTIS, Norman Perry & KELLEY, Carolyn June
23. JOHNSON, Gordon & MARIER, Sherry Jean
24. FORRESTER, Micheal A & MARIER, Jane Marie
25. KENNADAY, David Debernardi & SMITH, Paula Jo
26. KENNADAY, Steven Scott & LAVELLE, Catherine Susan
27. KENNADAY, Steven Scott & REED, Danielle
28. KENNADAY, Fredrick Frank & YOUNG, Brigid Ann
29. WHITMAN, Nelson Chester & PENDERGRASS, Cecelia Kay
30. WHITMAN, Nelson Chester & CORLETT, Claudette Irene
31. WHITMAN, Boyd David & THOMPSON, Carolyn M
32. WHITMAN, Richard Ward & JOUETT, Robin Knipp
33. BARTLETT, Joseph Grant & WHITMAN, Charlotte Louize
34. THOMPSON, Tommy M & WHITMAN, Marcella Ann
35. SMITH, Fred Winton & WHITMAN, Phillis Lana
36. SELF, Stanley Howard & WHITMAN, Laurel Alice
37. PAGE, Ronald Otis & CAIRNS, Linda Ann
38. CAMPBELL, Craig & CAIRNS, Christine Marie
39. CAIRNS, Jack Lavoy, Jr. & CASSLER, Rebecca
40. HANSEN, Alan & CAIRNS, Elizabeth Kay
41. CAIRNS, William Wayne & PORTER, Kae
42. COOPER, John Ellery & CAIRNS, Rebecca Gay
43. JEBENS, Carlie & WILSON, Phyllis Ann
44. KENNADAY, Thomas Earl & REAM, Gladys Eleanor
45. RAMSEY, Earl N & KENNADAY, Florence Mae
46. STOCKWELL, Ellen (Dude) & KENNADAY, Forest Jack
47. LOTT, Calvin & KENNADAY, Rose Marie
48. KELLEY, John David & KENNADAY, Iva June
49. JOHNSON, Gordon & KENNADAY, Bonnie Jean
50. MARIER, James Martin & KENNADAY, Bonnie Jean
51. KENNADAY, Lincoln Frank & DEBERNARDI, Joan Olivia

52. WHITMAN, Bruce Douglas & DAVIDSON, Frances Amonda
53. ROGERSON, Robert Orrin & DAVIDSON, Vita Maude
54. BLACKBURN, Harvey Alton & DAVIDSON, Louize Gertrude
55. DAVIDSON, Chester Clark & DADISMAN, Norma Hilda
56. ACKERSON, Walter Cecil & DAVIDSON, Eleanora Alice
57. DAVIDSON, Charles Daniel & NOLLER, Earlene Dee
58. HARNED, David Debernardi & DAVIDSON, Myrtle Rae
59. REDMAN, Ronald Clark & DAVIDSON, Myrtle Rae
60. CAIRNS, Jack Lavoy & JOHNSON, Beverly Ann
61. WILSON, Albert Norman & CAIRNS, Margaret Faunita
62. SCHMELING, Craig Martin & CAIRNS, Judy Ann
63. PETERS, Fred & KENNADAY, Rosa Marie
64. STEWART, Ed & KENNADAY, Anna Ruth
65. KENNADAY, Frank Forest & PIERCE, Mable
66. KENNADAY, Edward Thomas & MANNAHAN, Alice
67. DAVIDSON, Fairfax Harry & KENNADAY, Alice Oda May
68. KENNADAY, Charles Fredrick & BAYS, Margaret
69. CAIRNS, Logan Turner & KENNADAY, Emma Helen
70. KENNADAY, Loyd Andrew & HENDERSON, Inez
71. KENNADAY, Charles Alonzo & KENNEDY, Frances Elizabeth
72. KENNADAY, Andrew Jackson & MARSHEL, Anna
73. KENNADAY, John Hudson & VAN ORSDEL, Anne Elizabeth
74. KENNADAY, James & HUDSON, Sarah

1. James Vencent Boyd & Brenda Sue Sobo

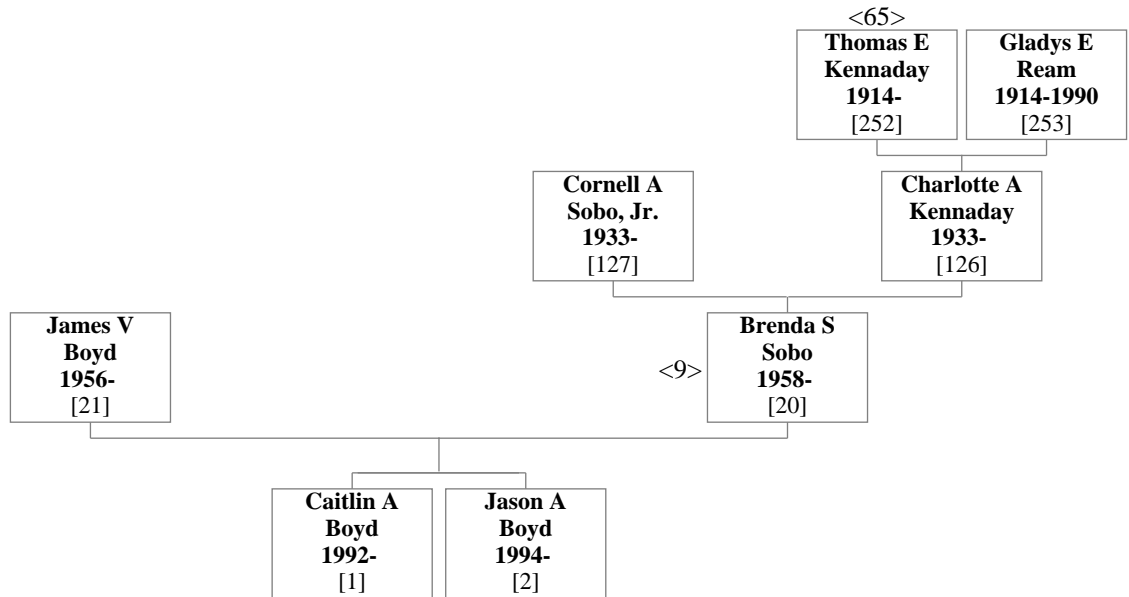

2. Randy Eugene Sobo & Kim Eileen Johnson

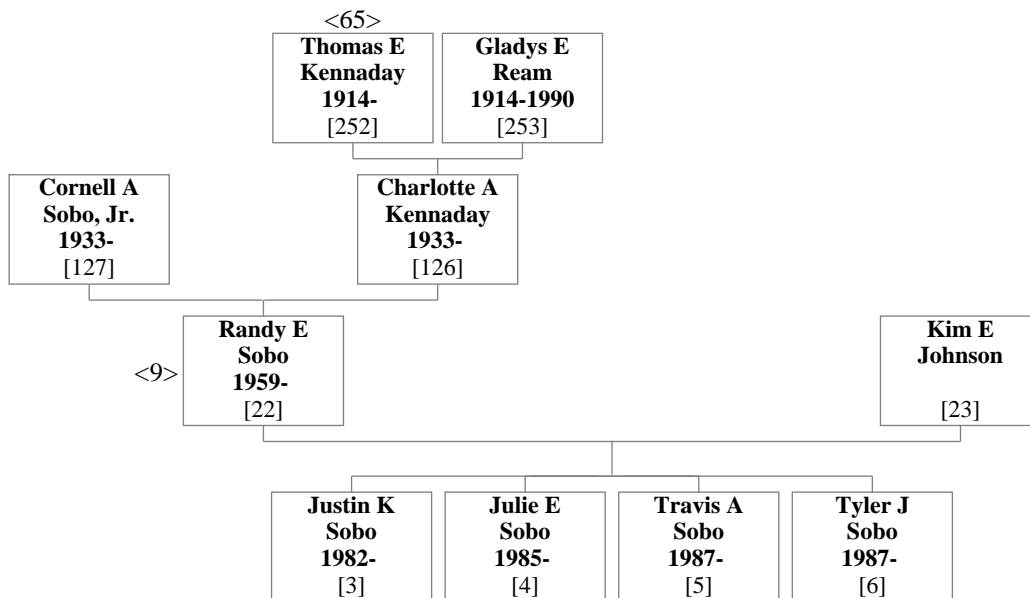

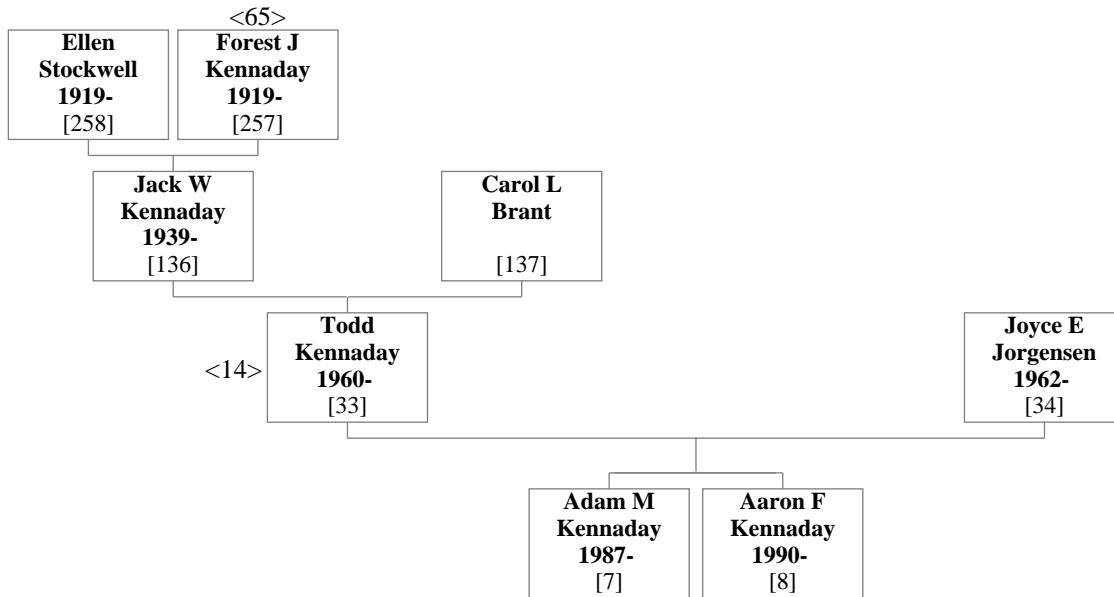
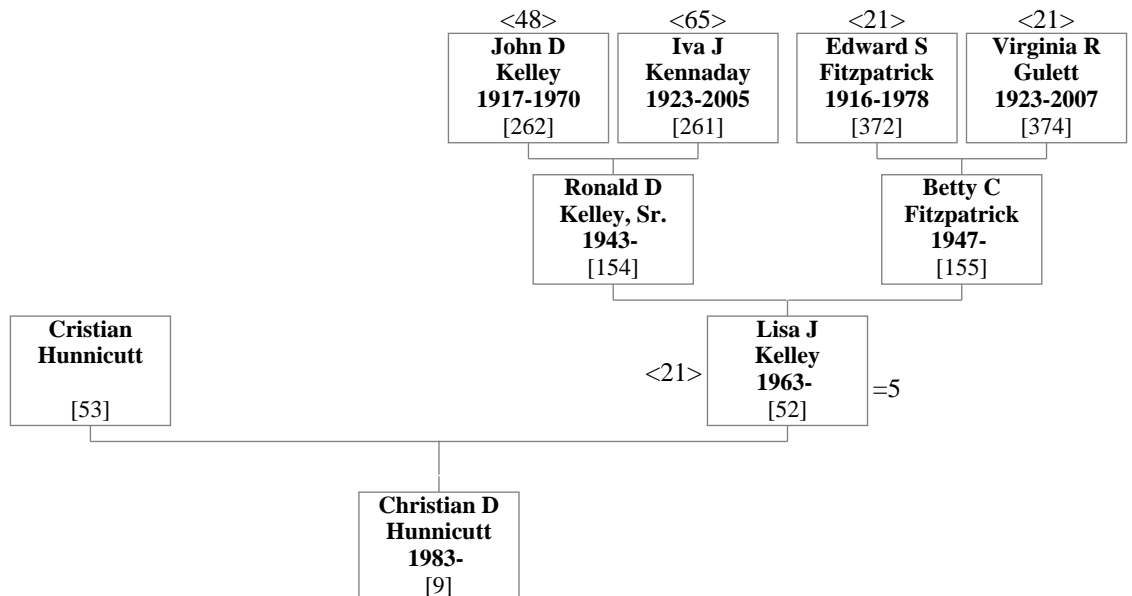
3. Todd Kennaday & Joyce Ellen Jorgensen**4. Cristian Hunnicutt & Lisa June Kelley**

5. James Mickel Asbury & Lisa June Kelley

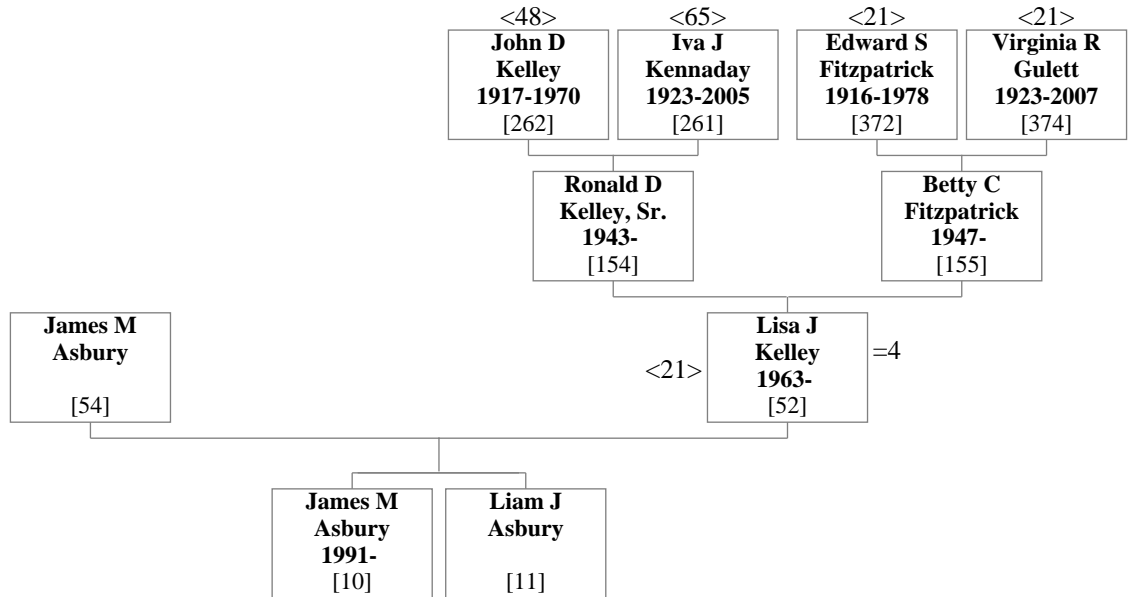

6. Mark Meyer & Sherrie (Like a Daughter) Jones

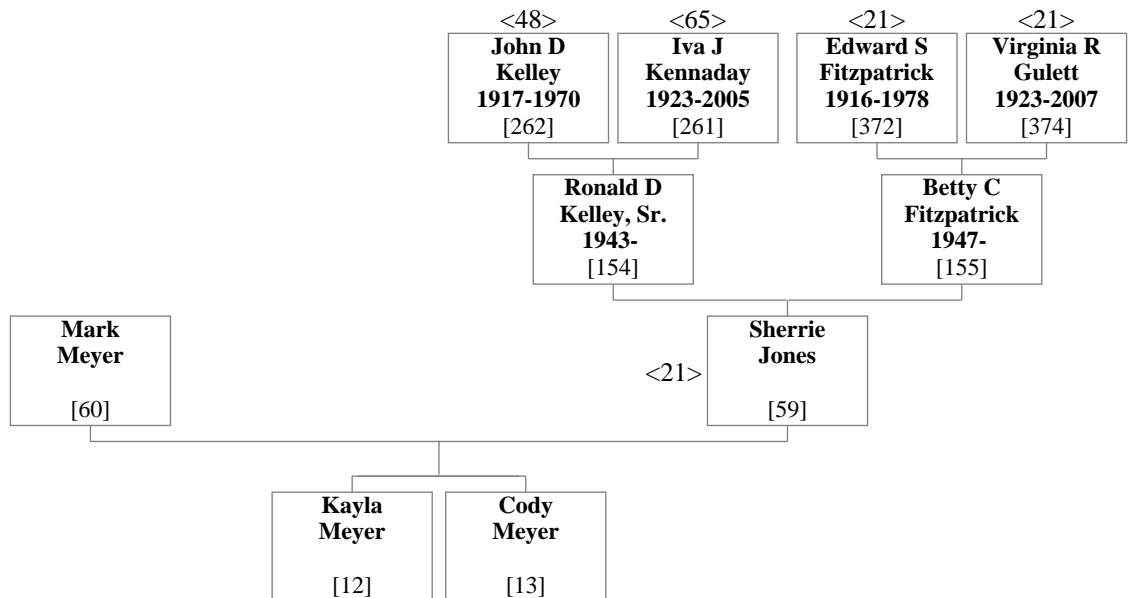

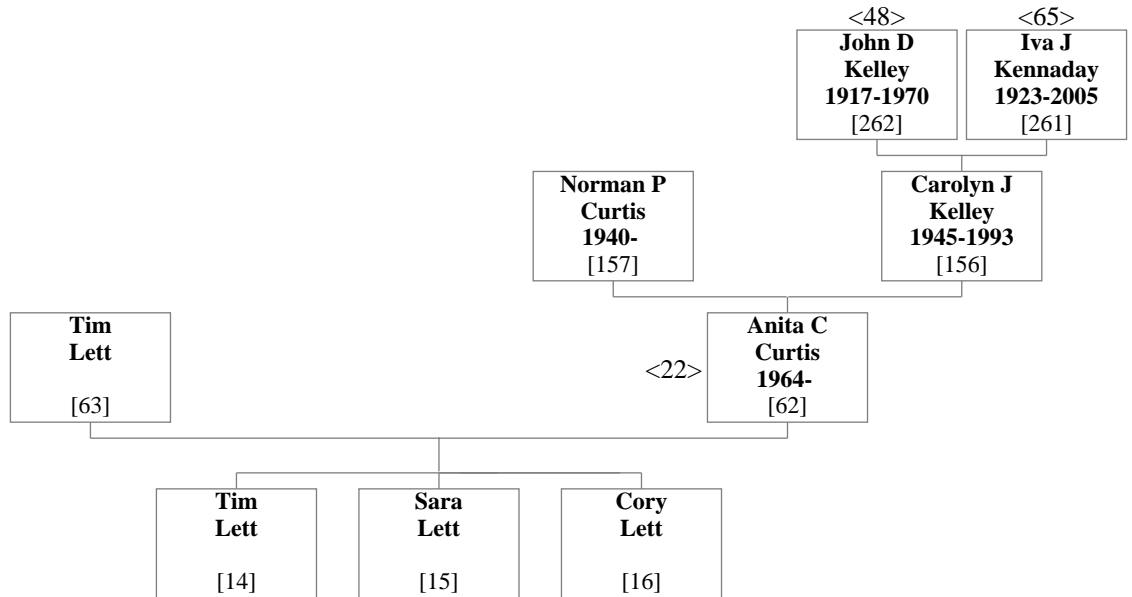
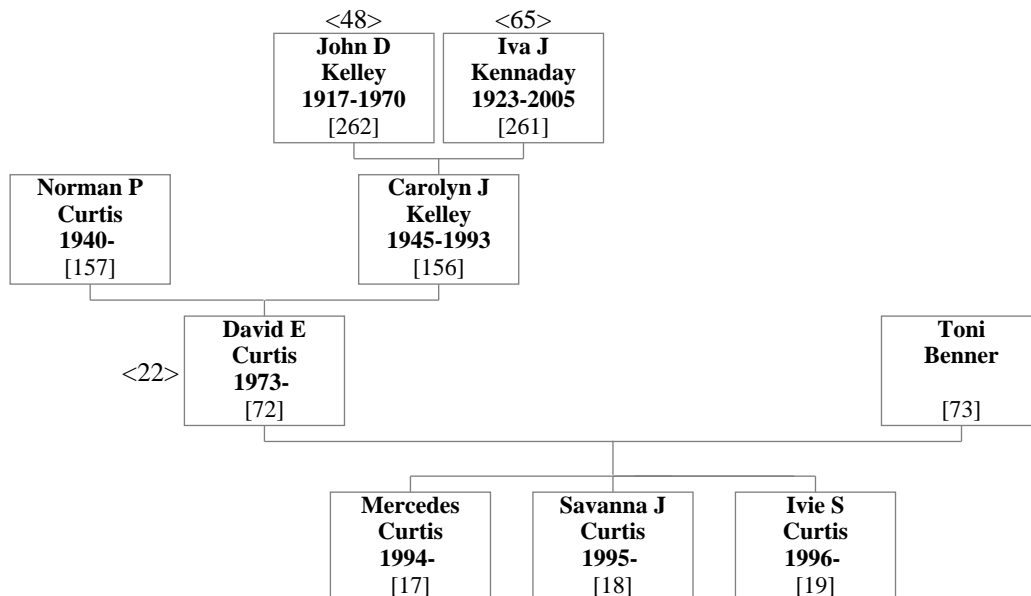
7. Tim Lett & Anita Carol Curtis8. David Earl Curtis & Toni Benner

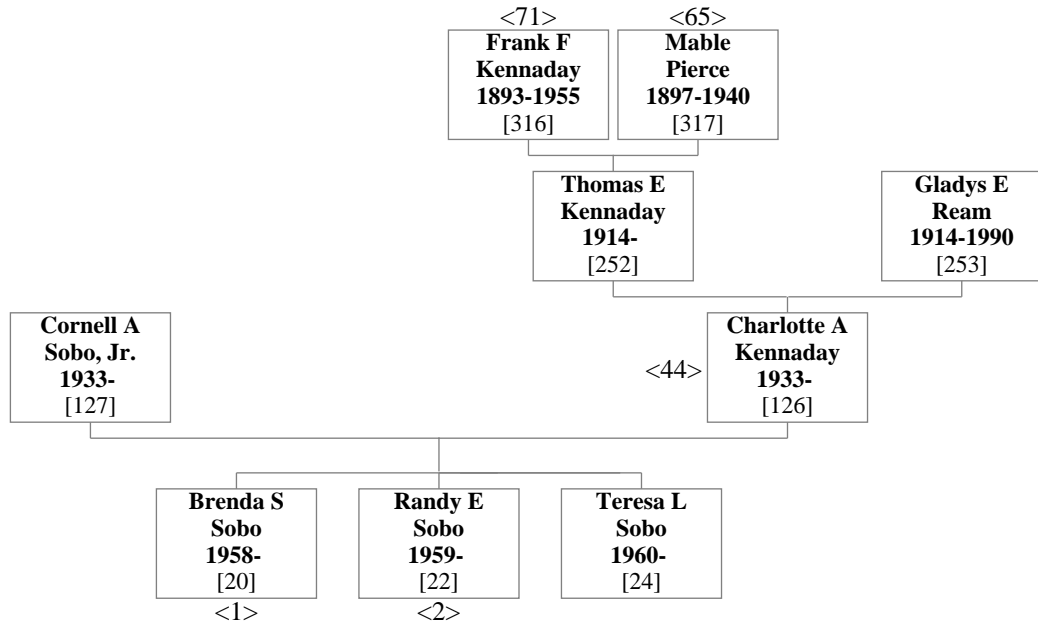
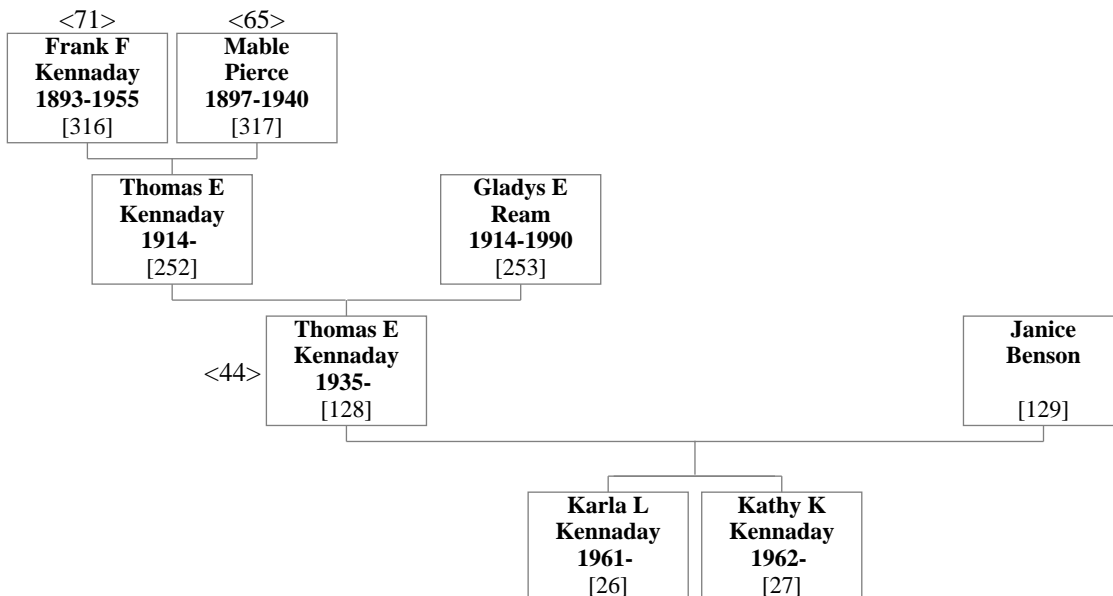
9. Cornell Alexander Sobo, Jr. & Charlotte Arlene Kennaday**10. Thomas Eugene Kennaday & Janice Benson**

11. August Henry Geppert & Patty Ray Kennaday

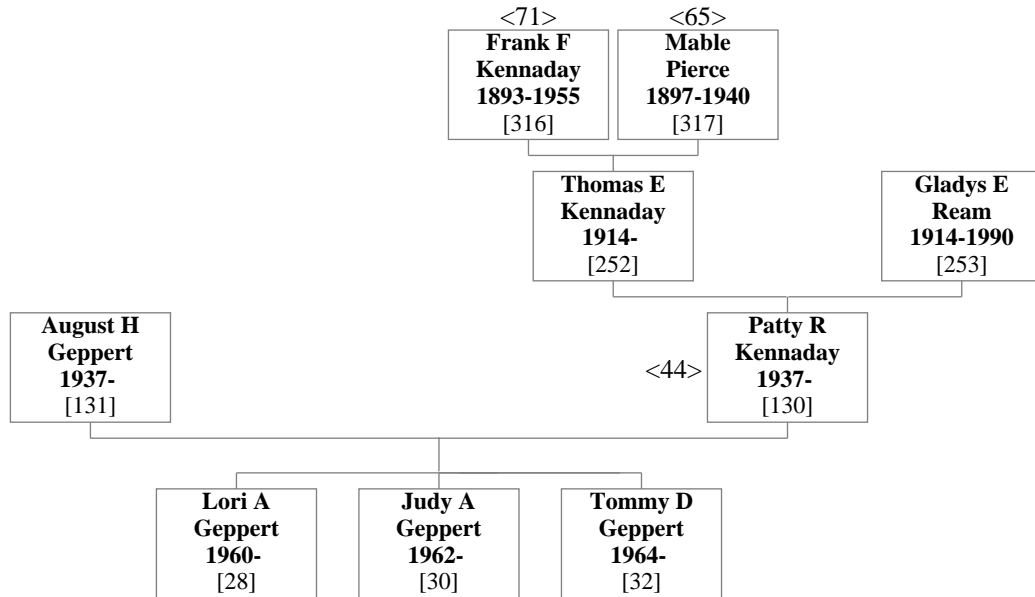

12. Earl Efton (Butch) Ramsey & Rosa L Hubbard

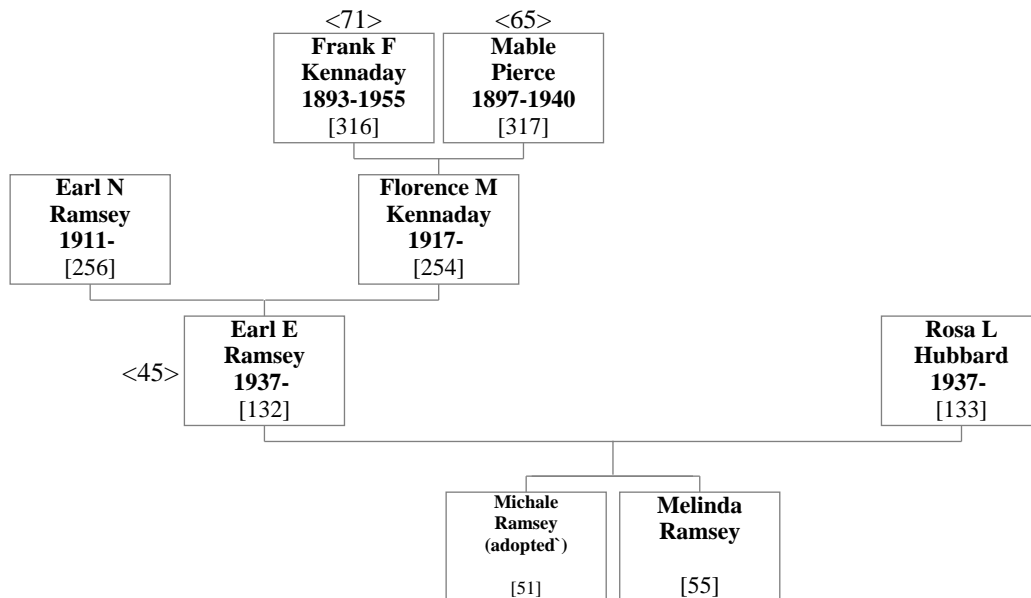

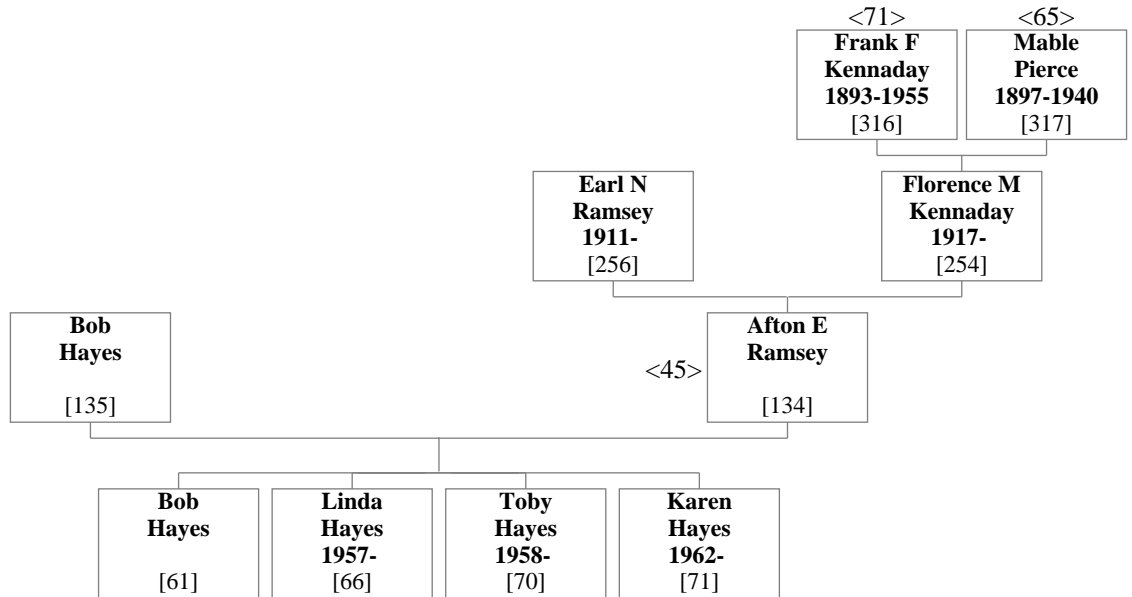
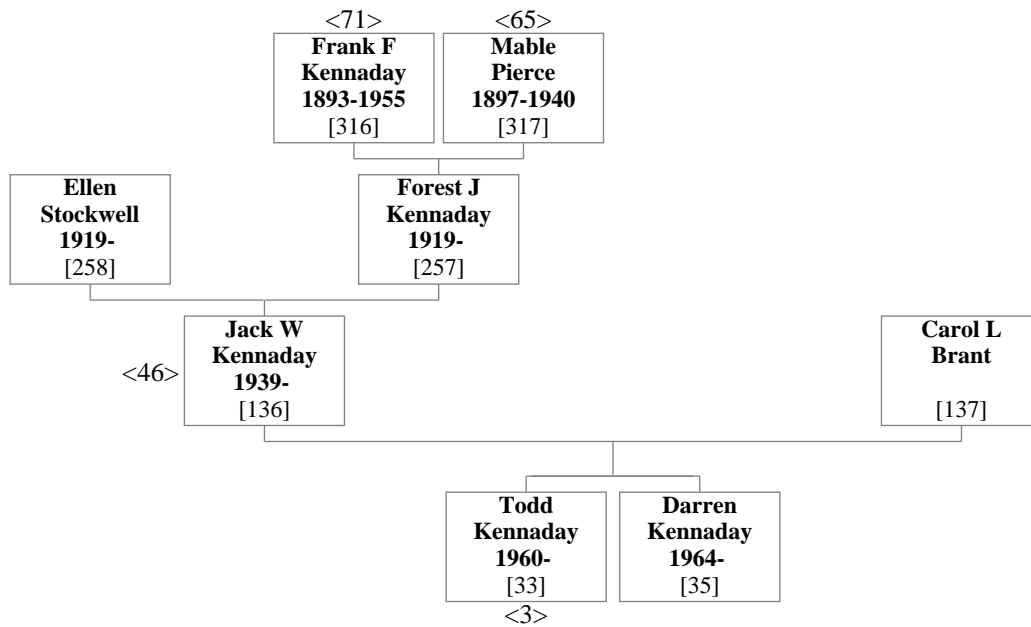
13. Bob Hayes & Afton Ernstine (Marier) Ramsey**14. Jack Wayne Kennaday & Carol Lee Brant**

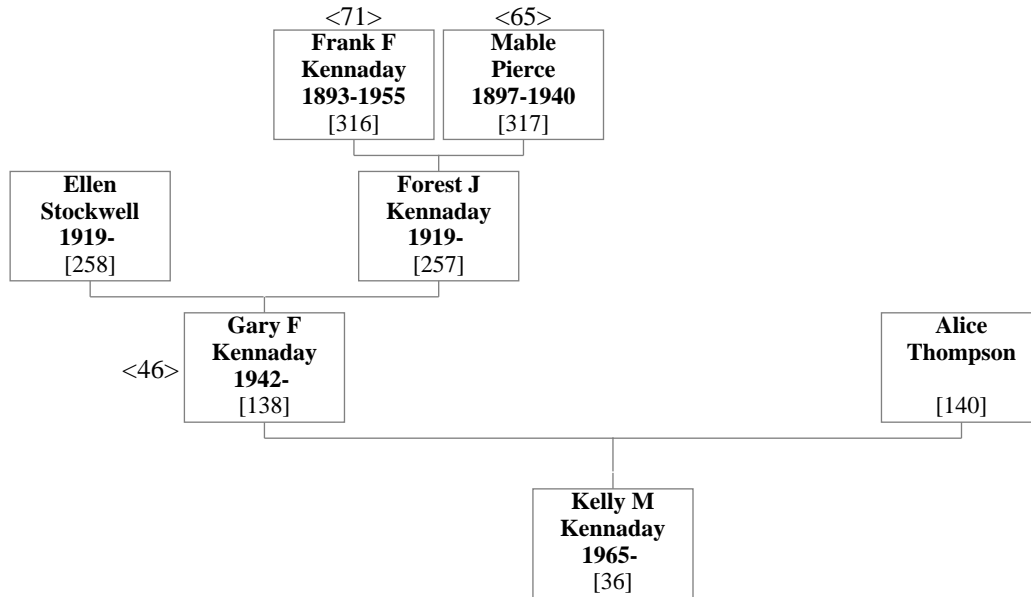
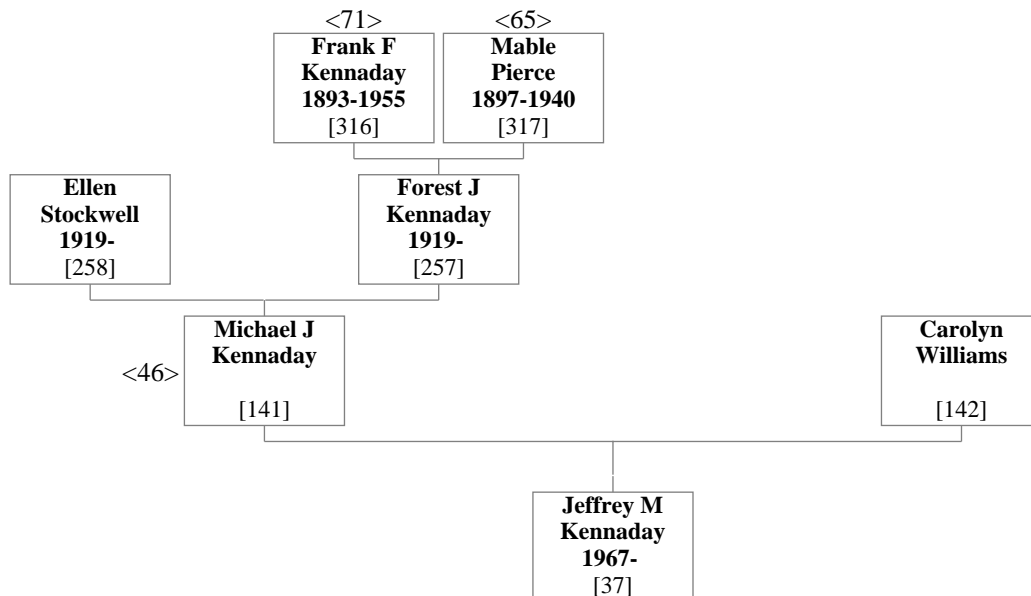
15. Gary Forrest Kennaday & Alice Thompson**16. Michael Joseph Kennaday & Carolyn Williams**

17. Jimmy Ray Lott & Ellen Dollar Hyde

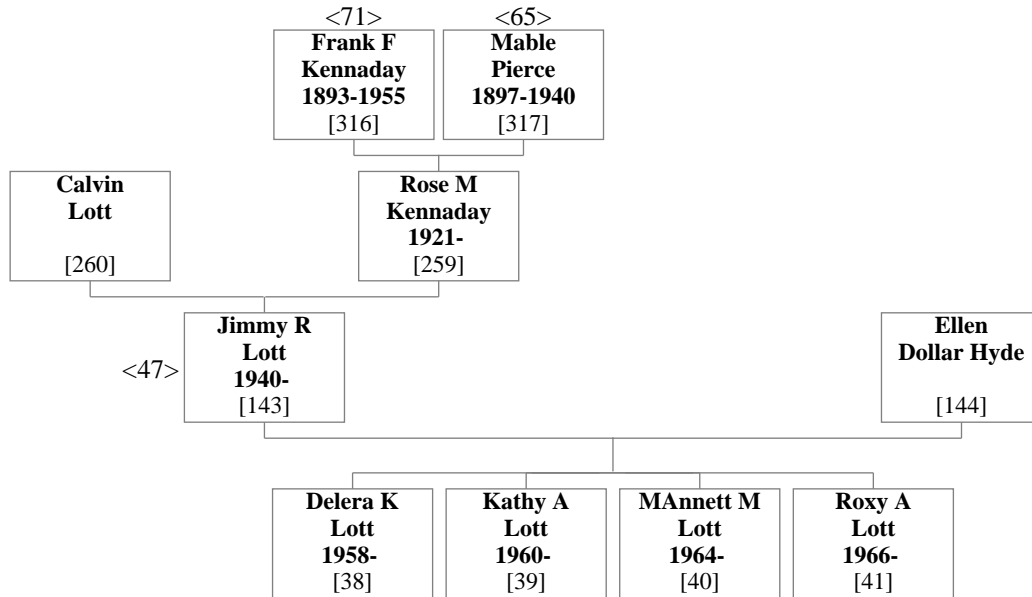

18. Al Blunt & Rosa Lee Lott

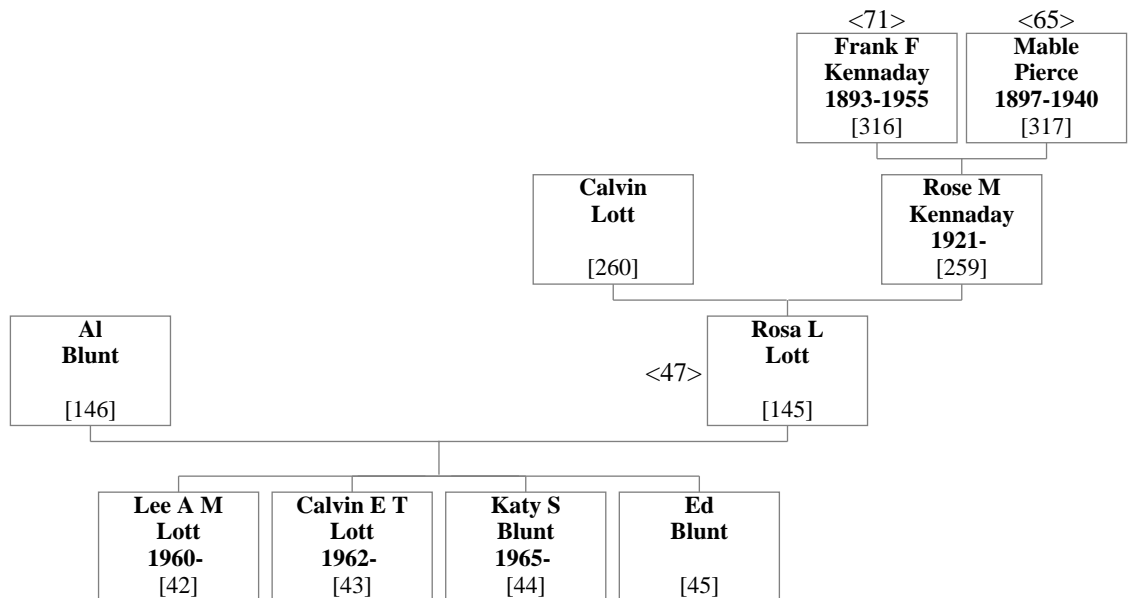

19. Calvin Jay Lott & Jo Ann Sturgess

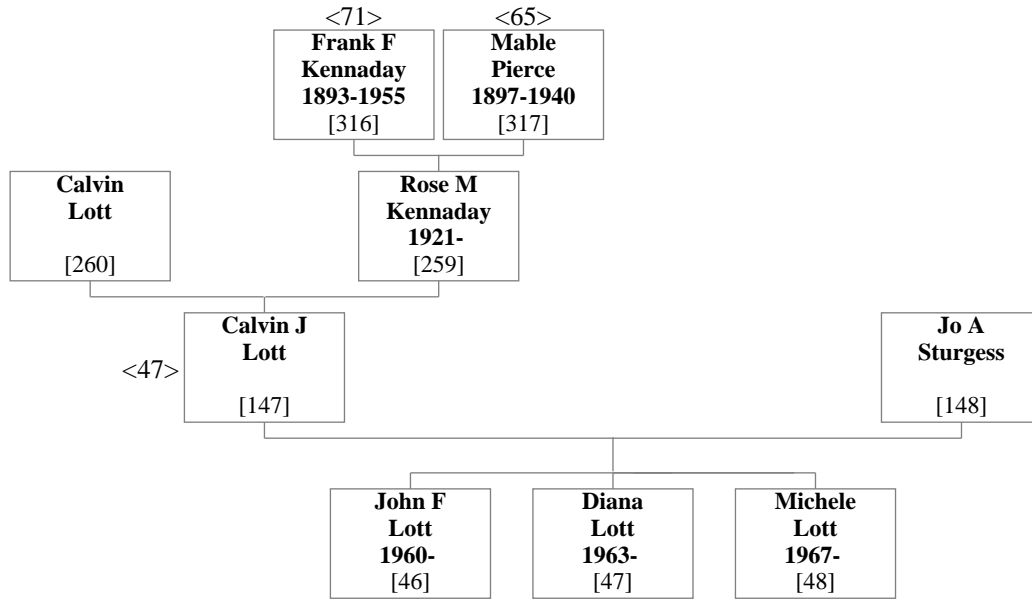

20. Mr. Sloane & Mable Bea Lott

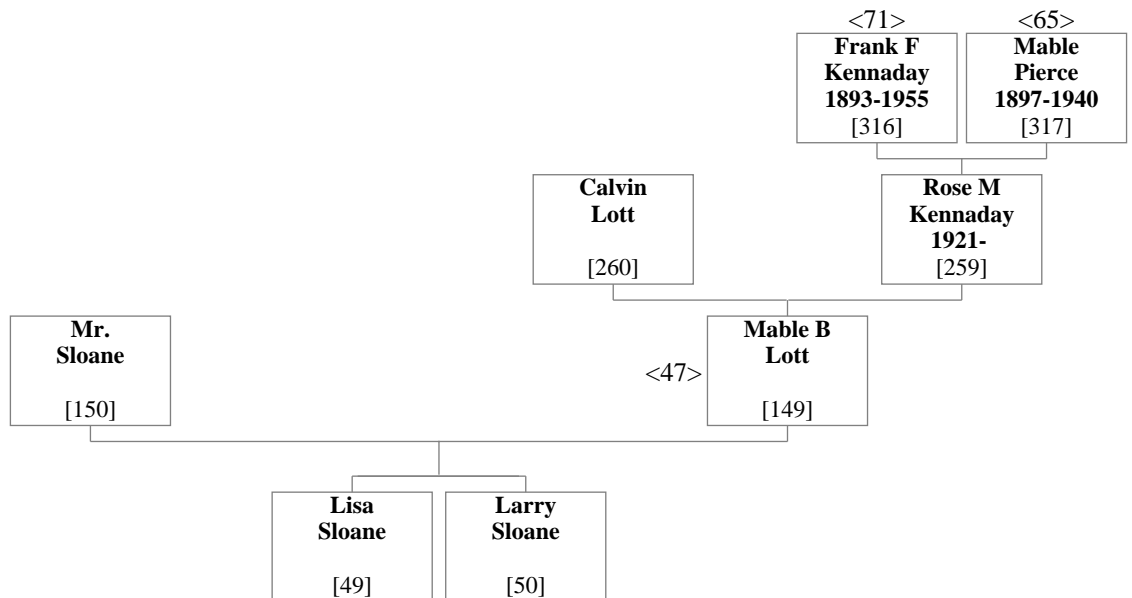

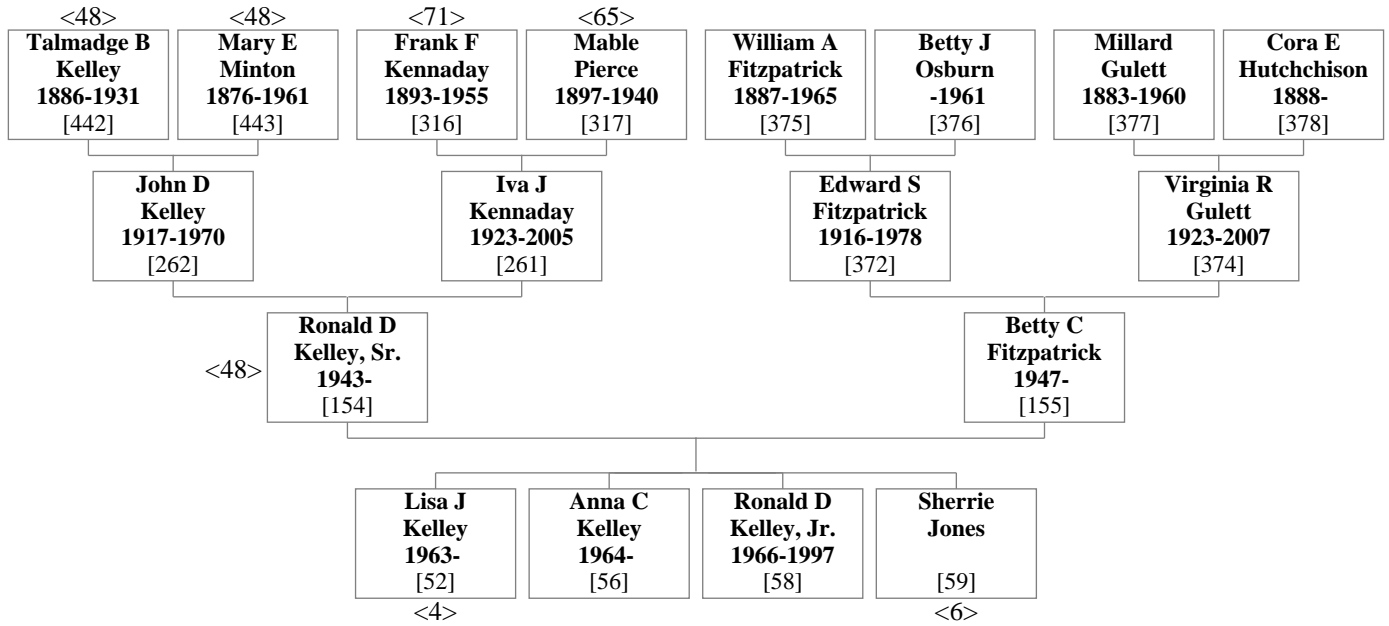
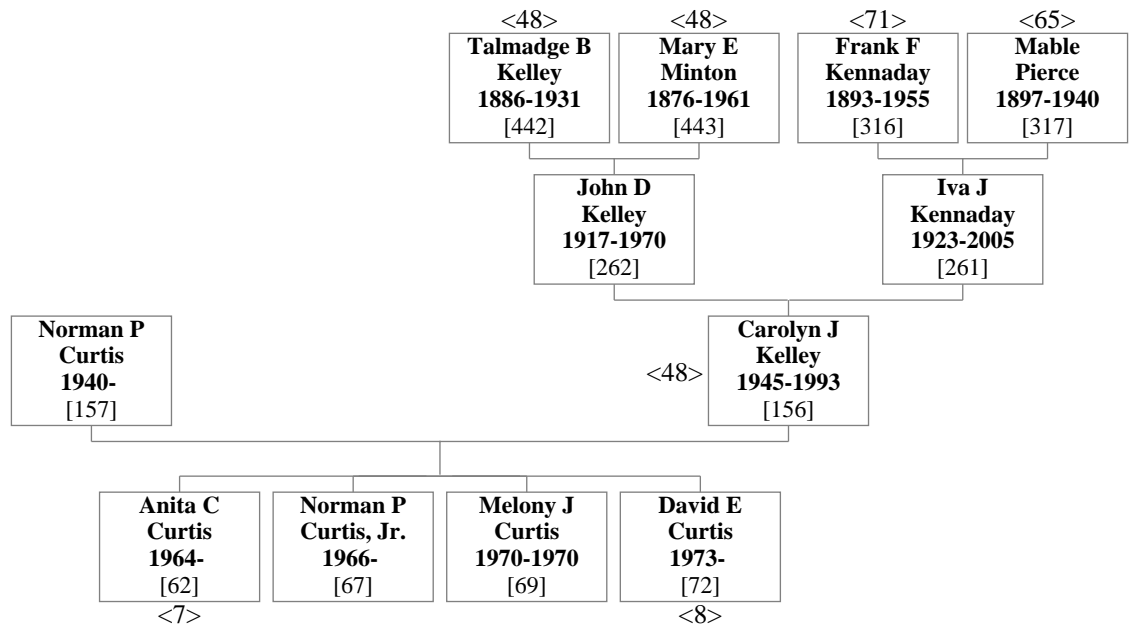
21. Ronald David Kelley, Sr. & Betty Carol Fitzpatrick**22. Norman Perry Curtis & Carolyn June Kelley**

23. Gordon Johnson & Sherry Jean Marier

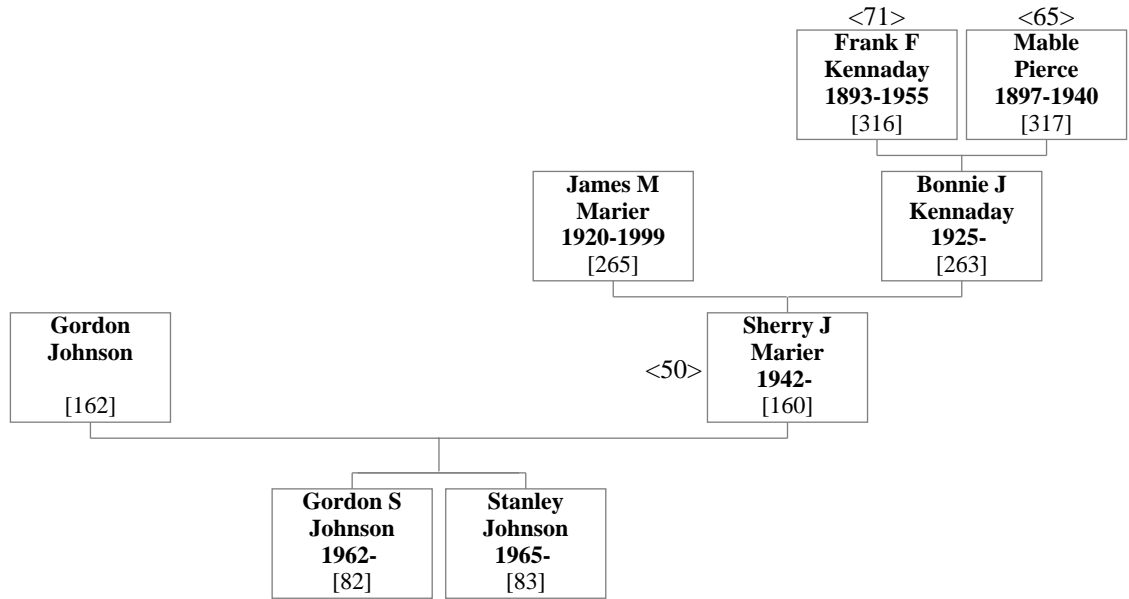

24. Micheal A Forrester & Jane Marie Marier

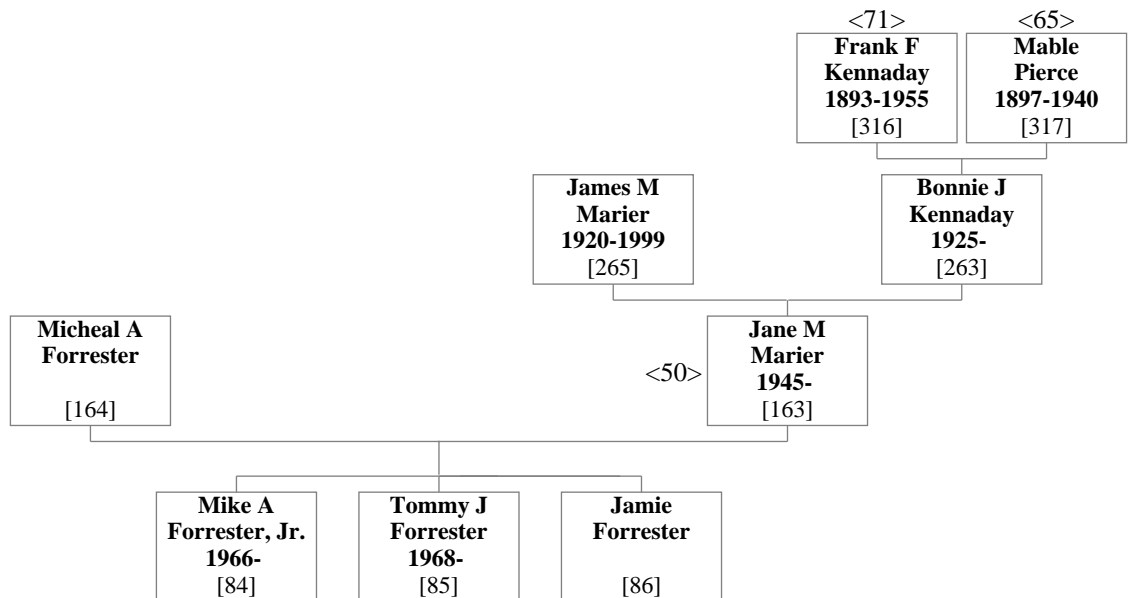

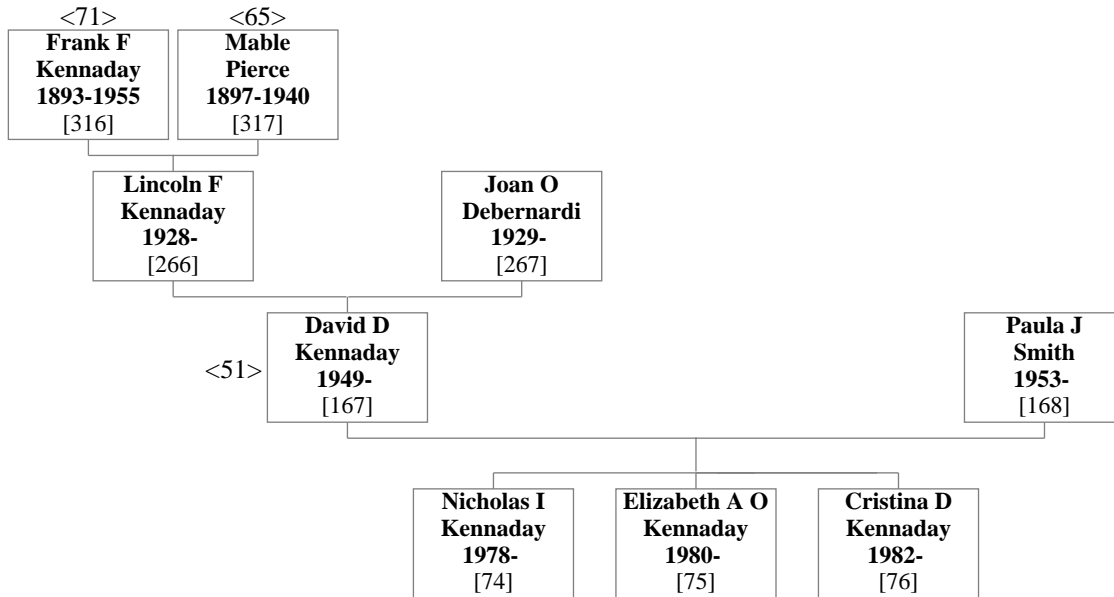
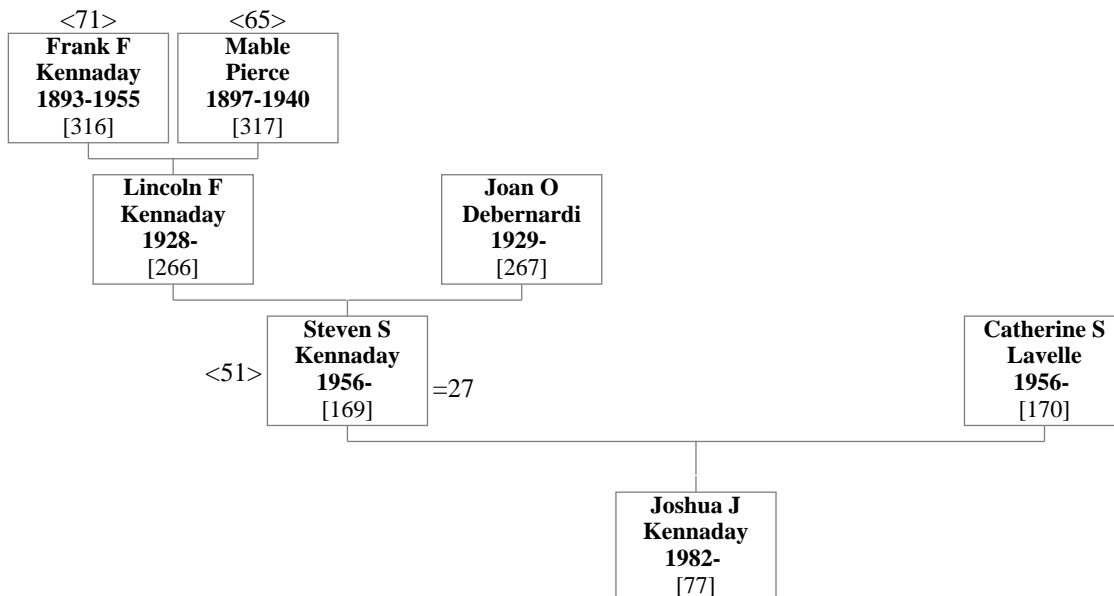
25. David Debernardi Kennaday & Paula Jo Smith26. Steven Scott Kennaday & Catherine Susan Lavelle

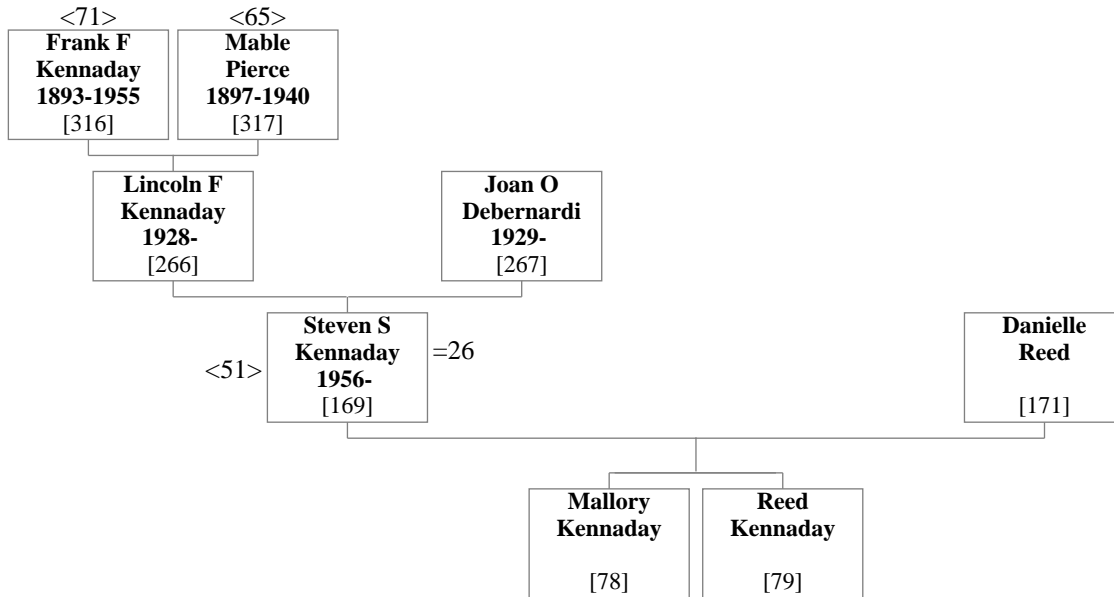
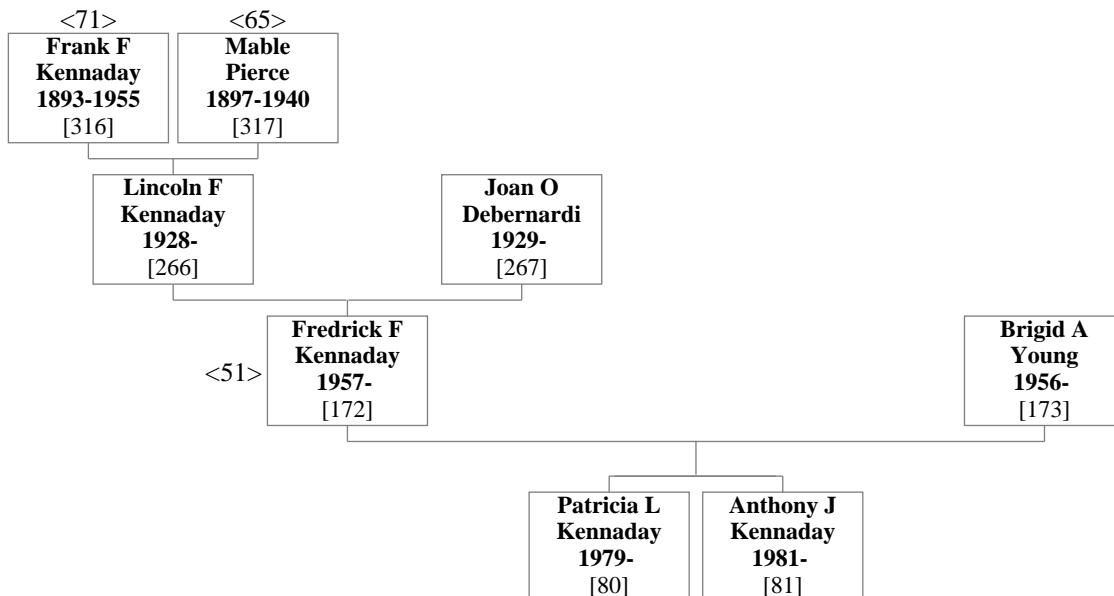
27. Steven Scott Kennaday & Danielle Reed28. Fredrick Frank Kennaday & Brigid Ann Young

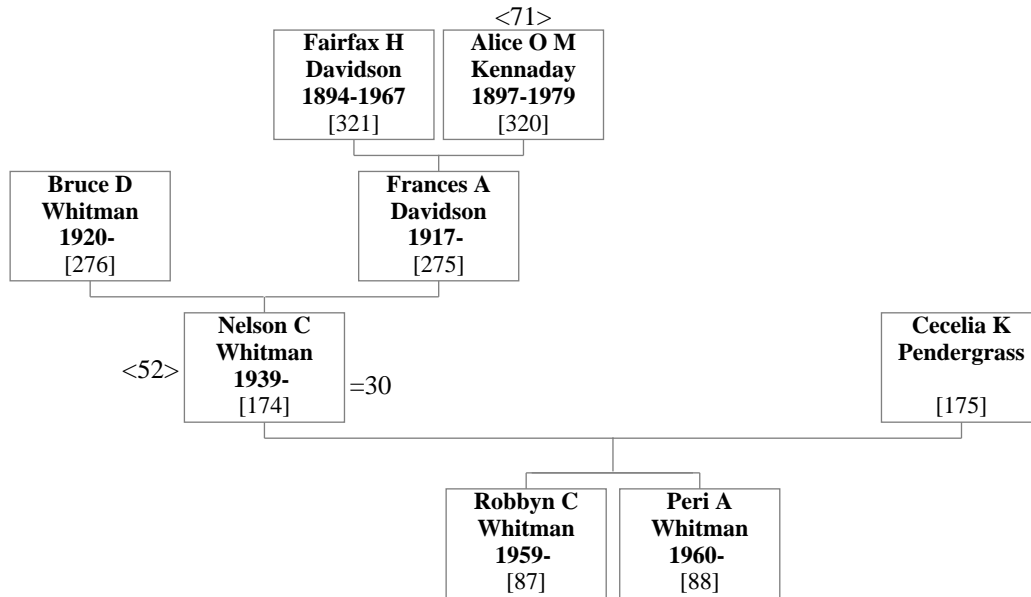
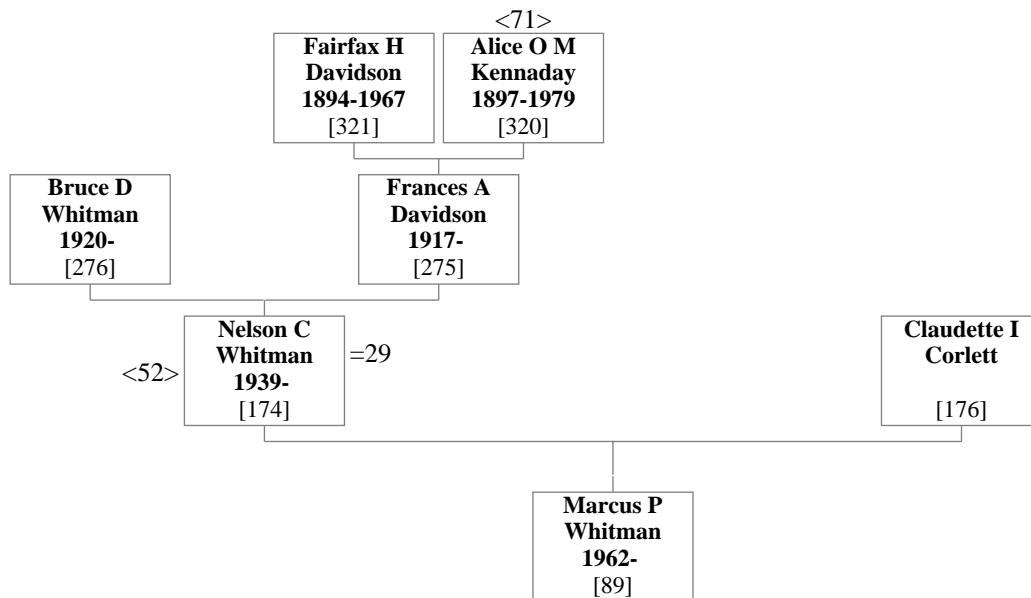
29. Nelson Chester Whitman & Cecelia Kay Pendergrass**30. Nelson Chester Whitman & Claudette Irene Corlett**

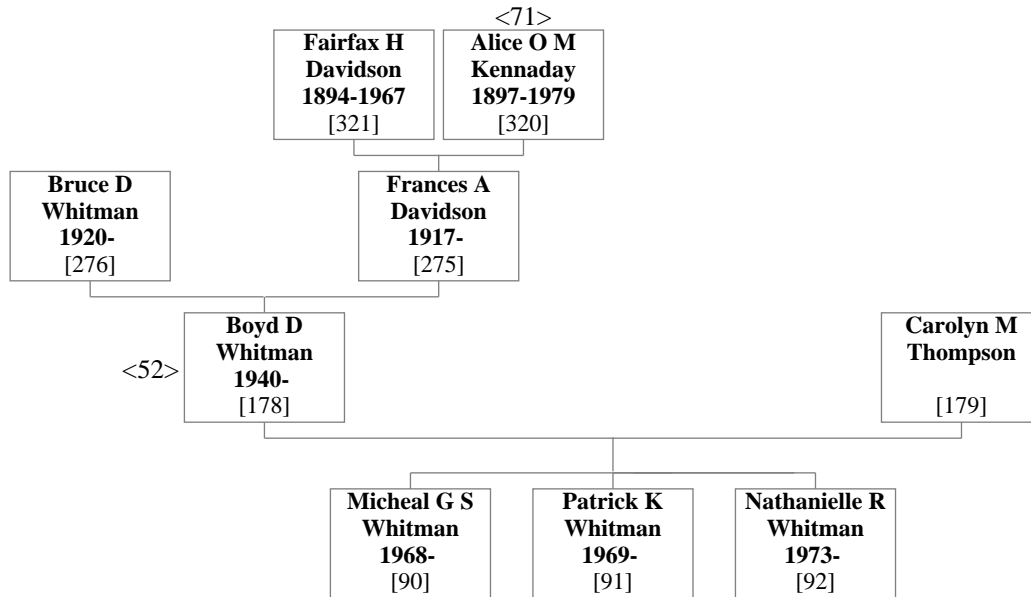
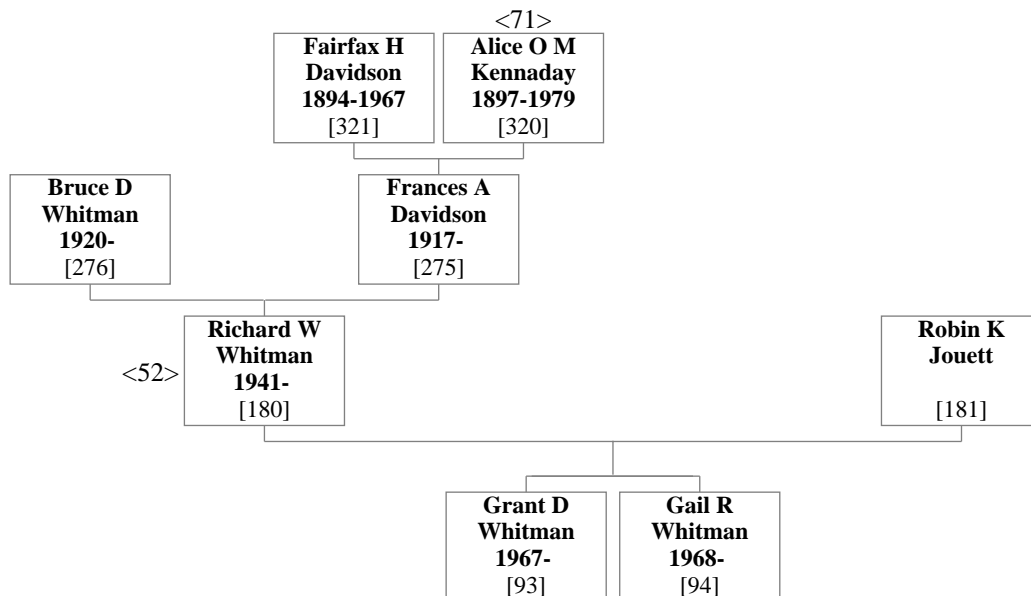
31. Boyd David Whitman & Carolyn M Thompson**32. Richard Ward Whitman & Robin Knipp Jouett**

33. Joseph Grant Bartlett & Charlotte Louize Whitman

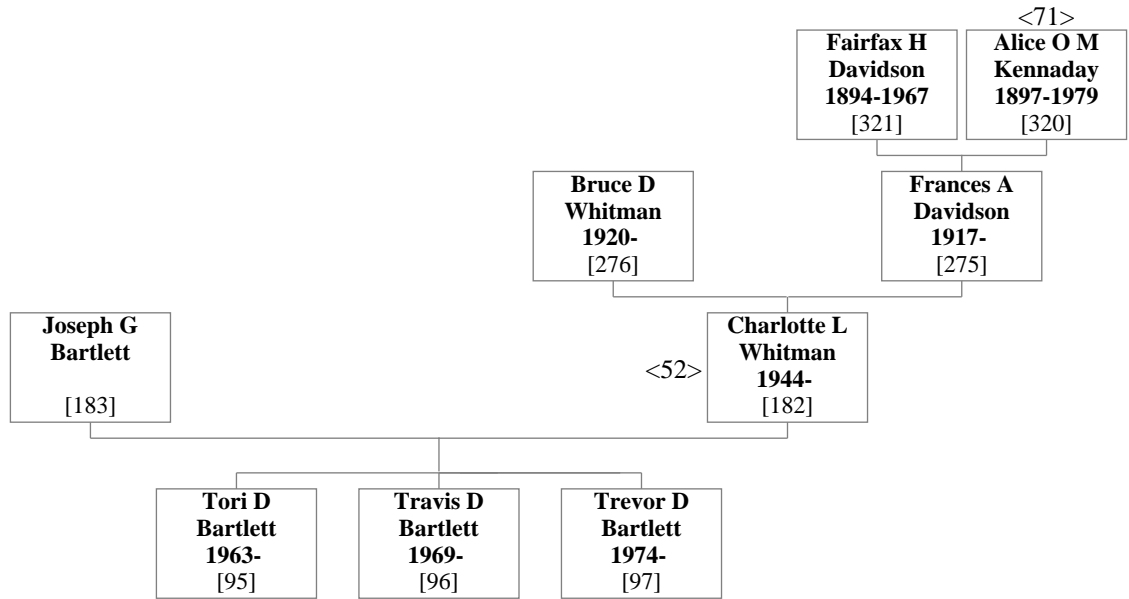

34. Tommy M Thompson & Marcella Ann Whitman

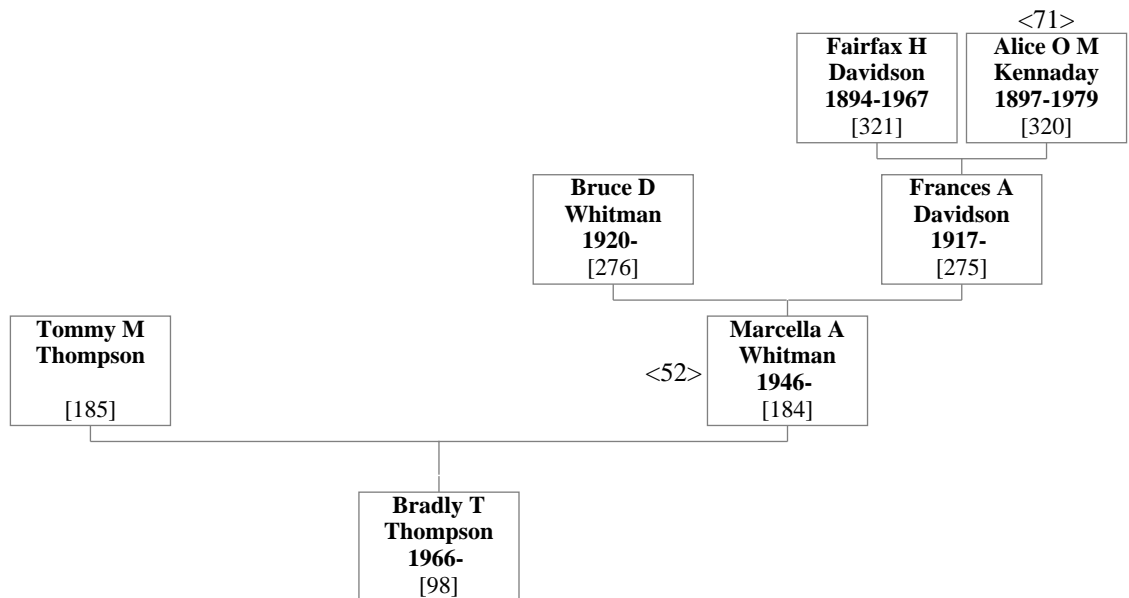

35. Fred Winton Smith & Phillis Lana Whitman

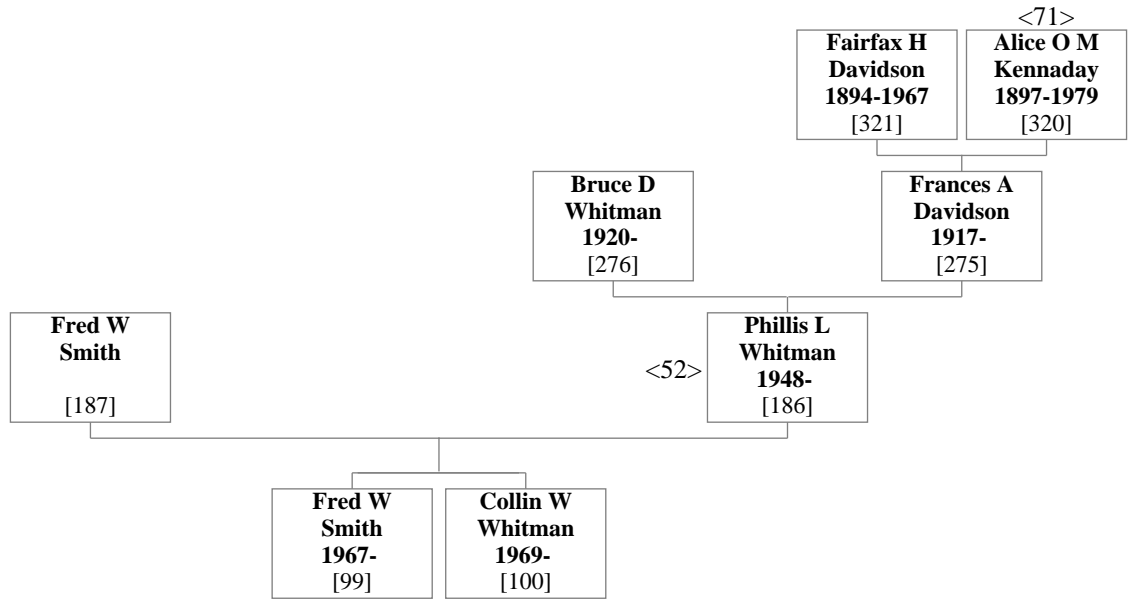

36. Stanley Howard Self & Laurel Alice Whitman

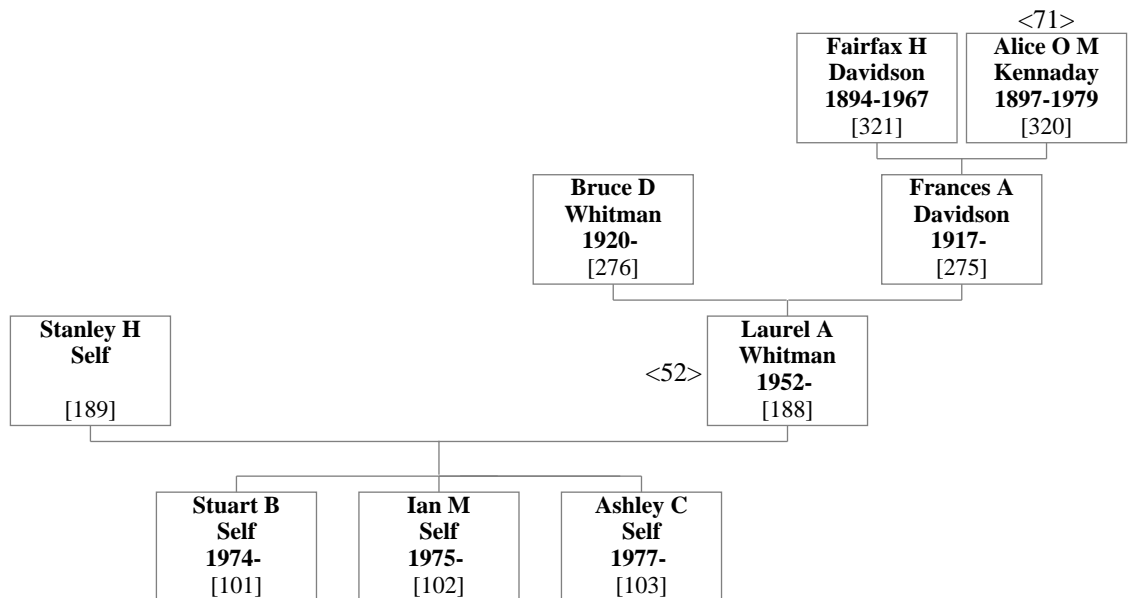

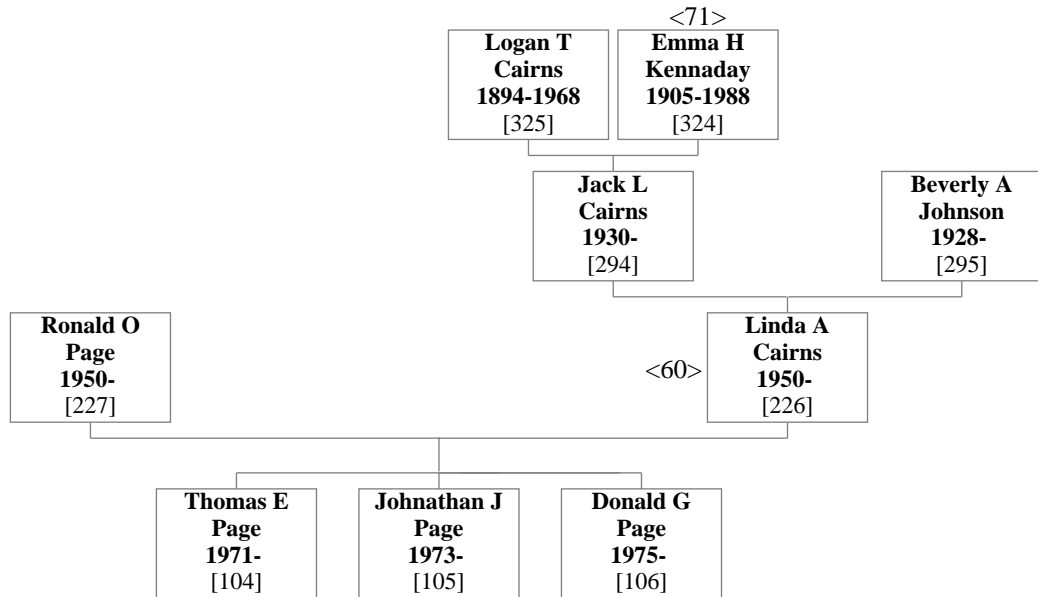
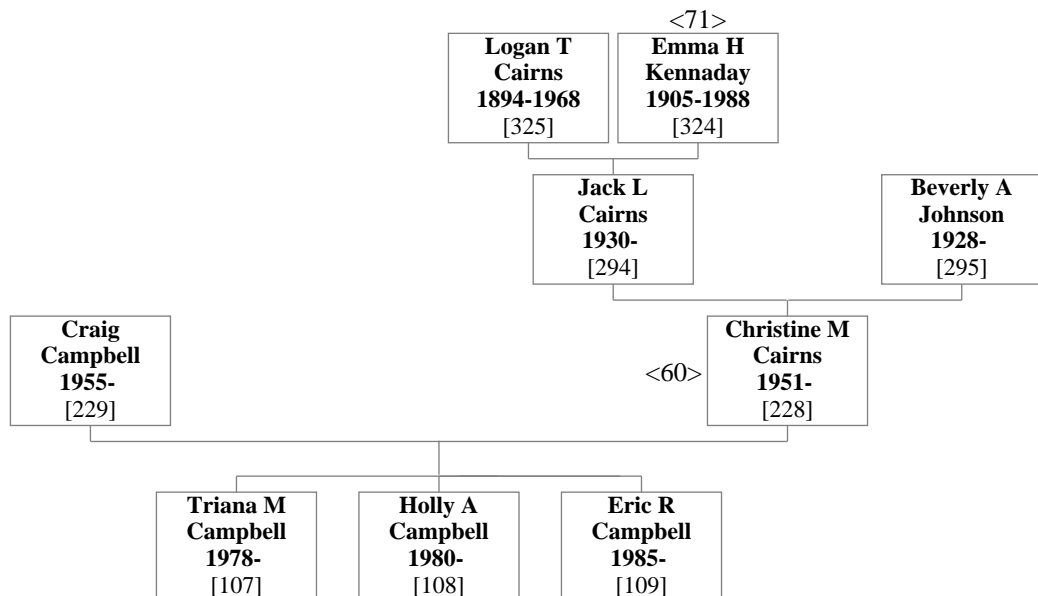
37. Ronald Otis Page & Linda Ann Cairns**38. Craig Campbell & Christine Marie Cairns**

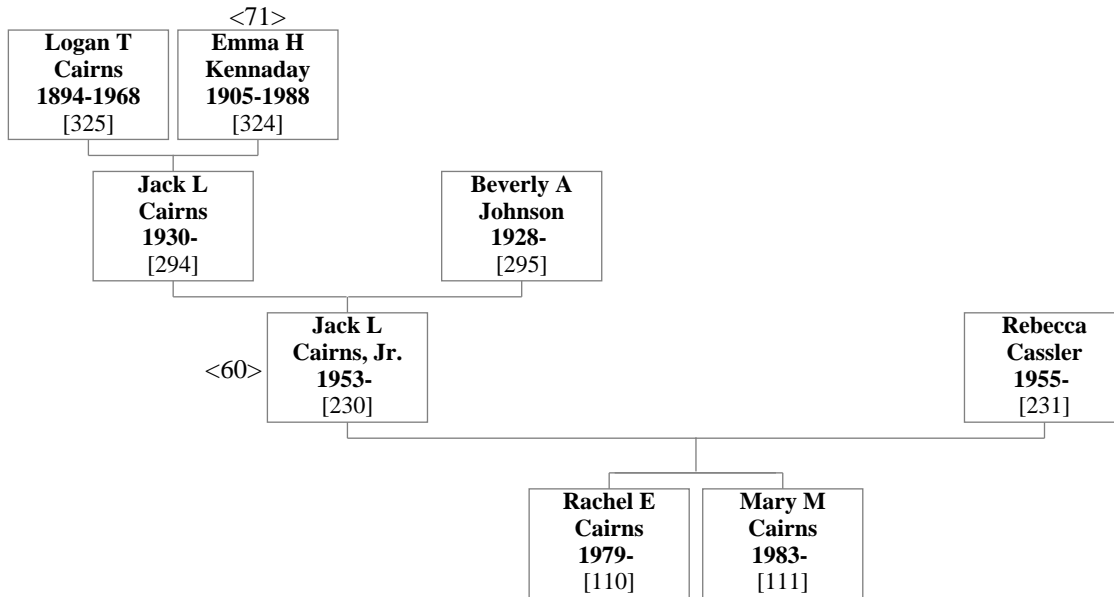
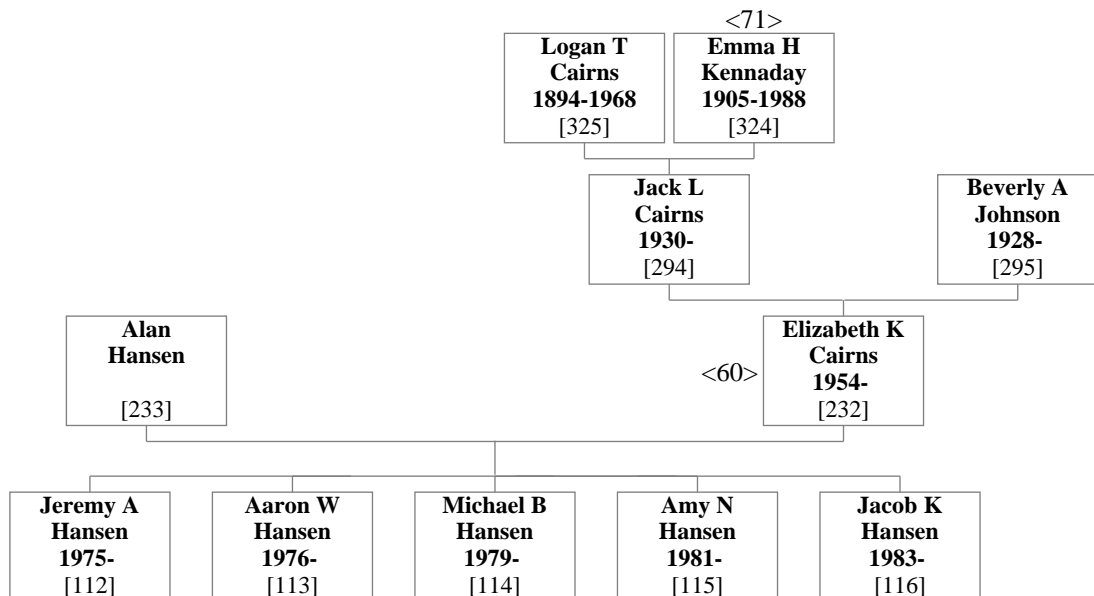
39. Jack Lavoy Cairns, Jr. & Rebecca Cassler**40. Alan Hansen & Elizabeth Kay Cairns**

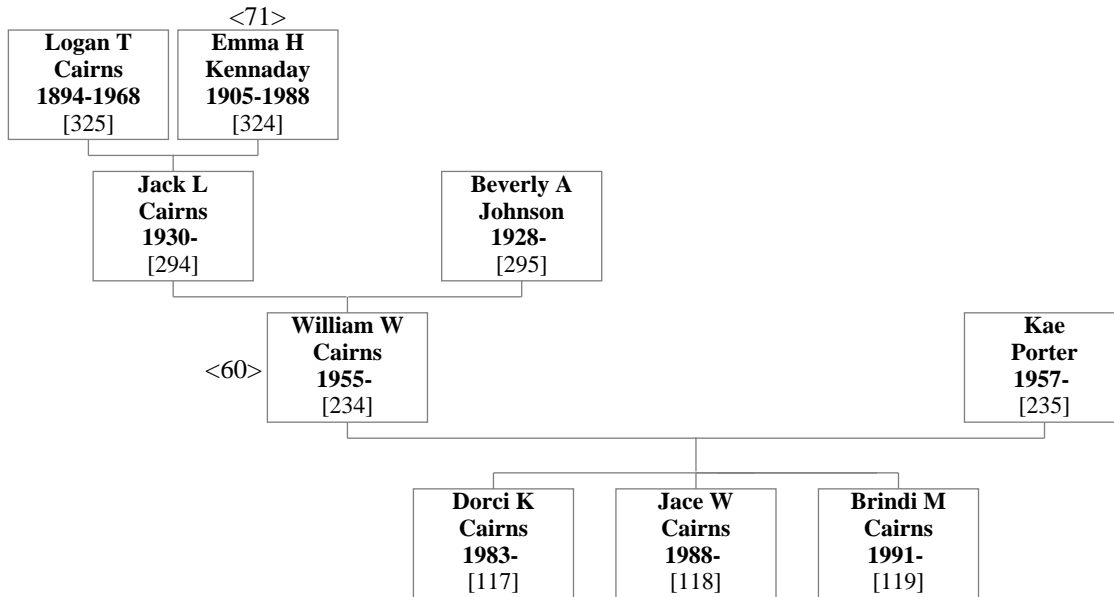
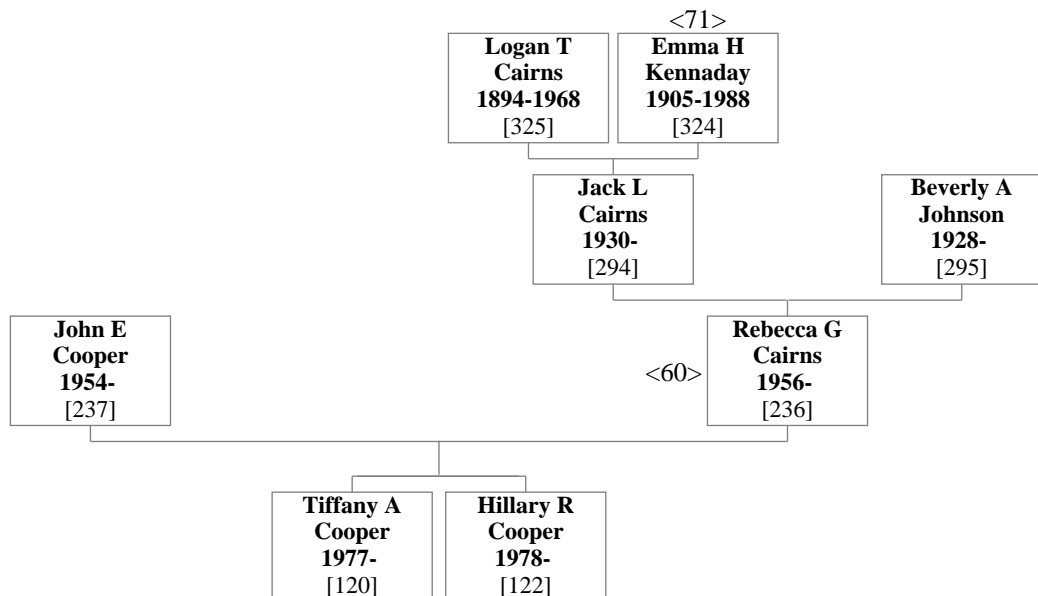
41. William Wayne Cairns & Kae Porter42. John Ellery Cooper & Rebecca Gay Cairns

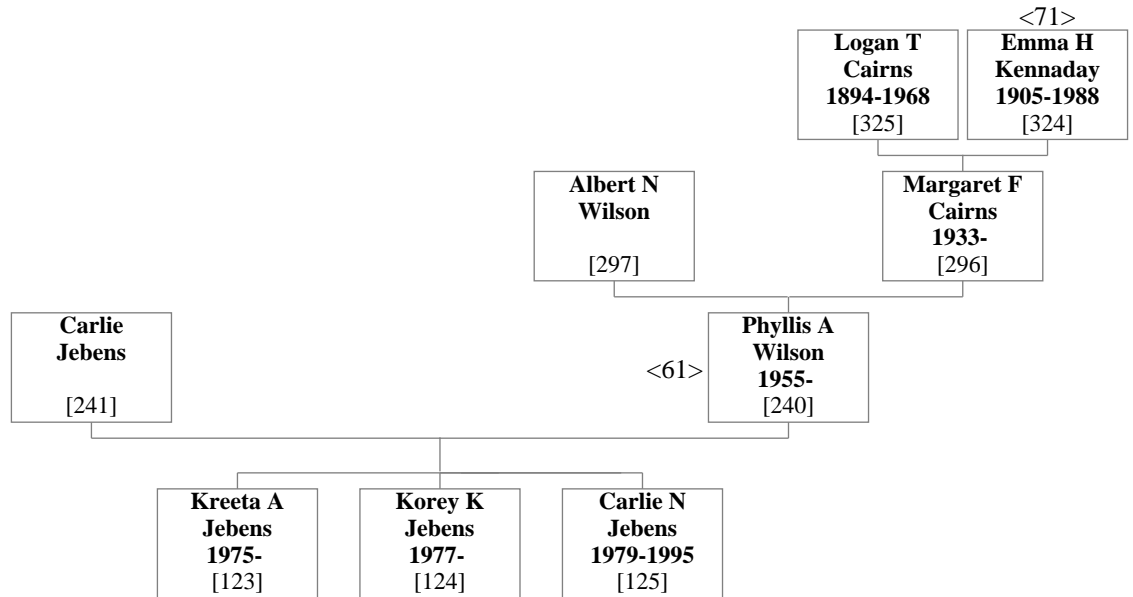
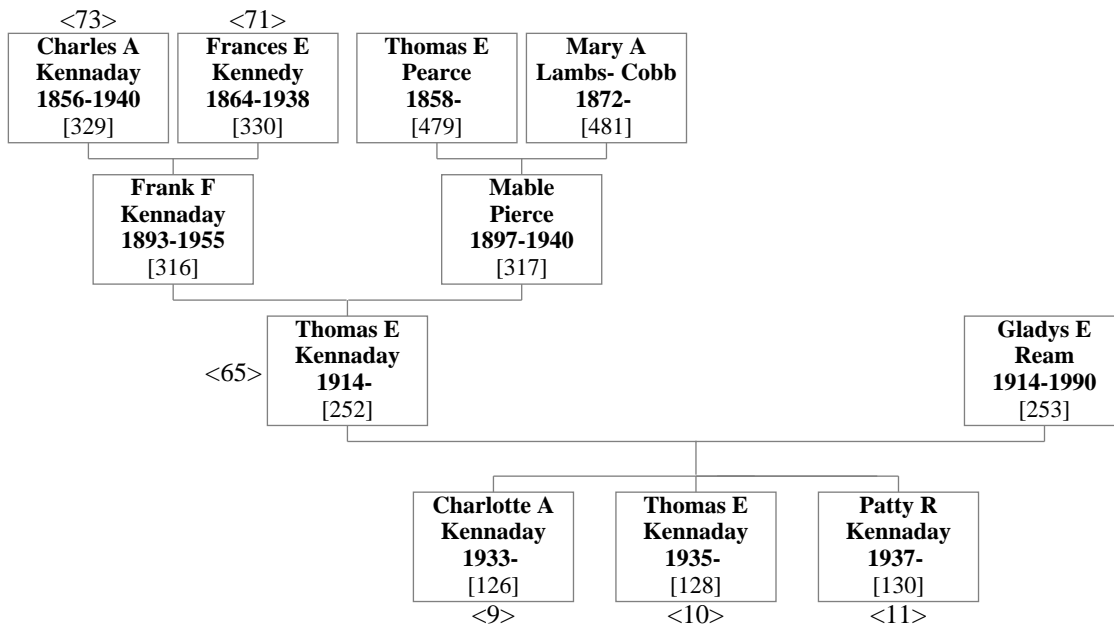
43. Carlie Jebens & Phyllis Ann Wilson44. Thomas Earl Kennaday & Gladys Eleanor Ream

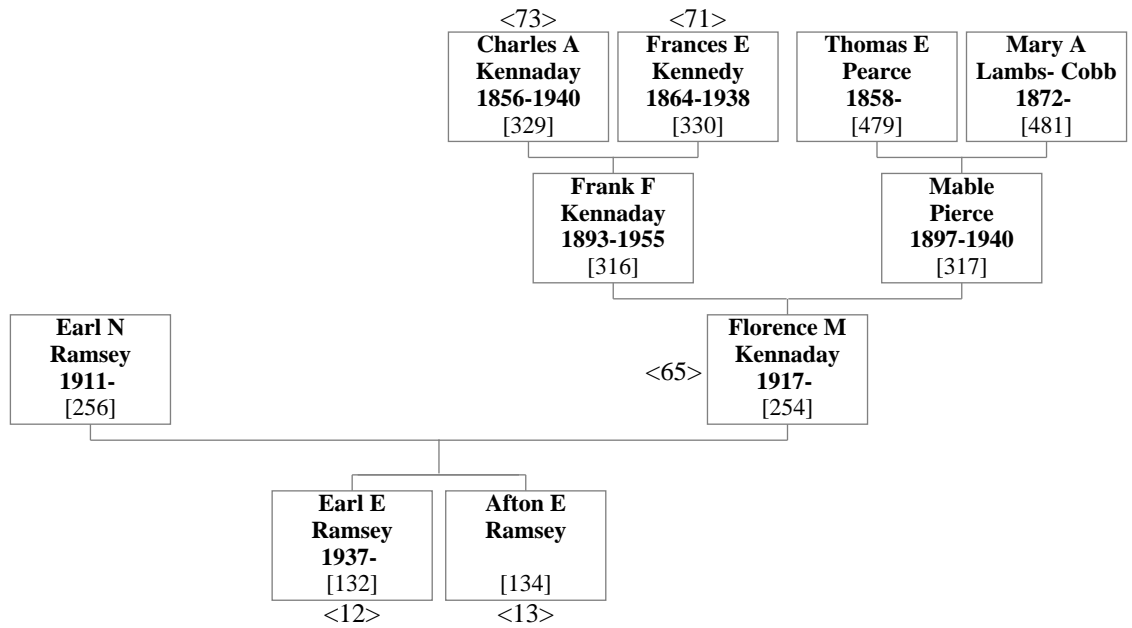
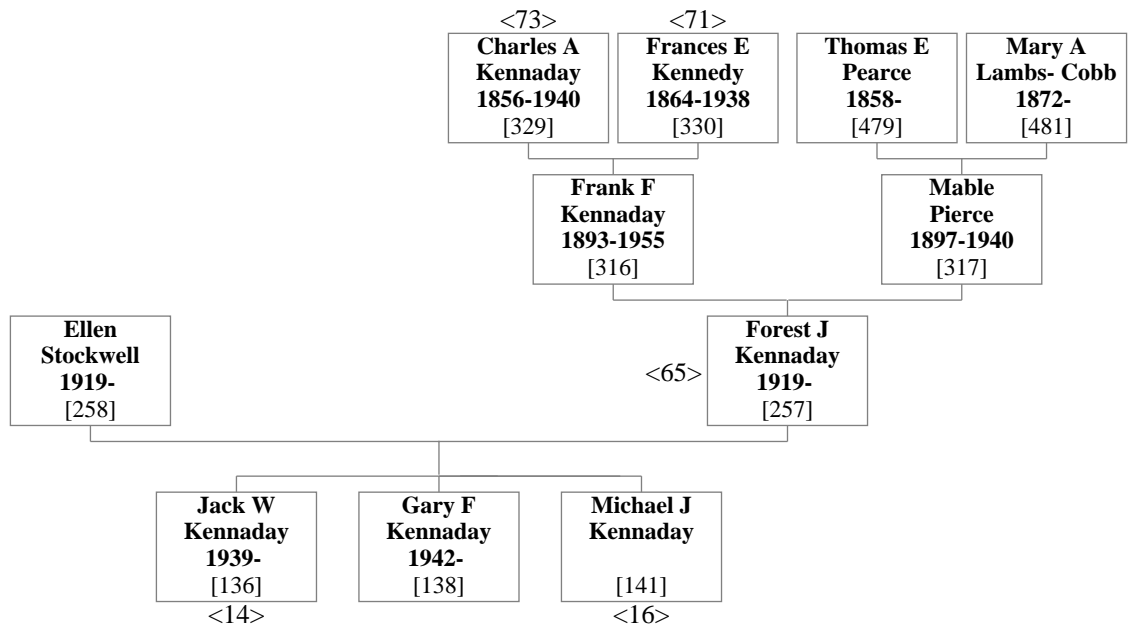
45. Earl N Ramsey & Florence Mae Kennaday**46. Ellen (Dude) Stockwell & Forest Jack Kennaday**

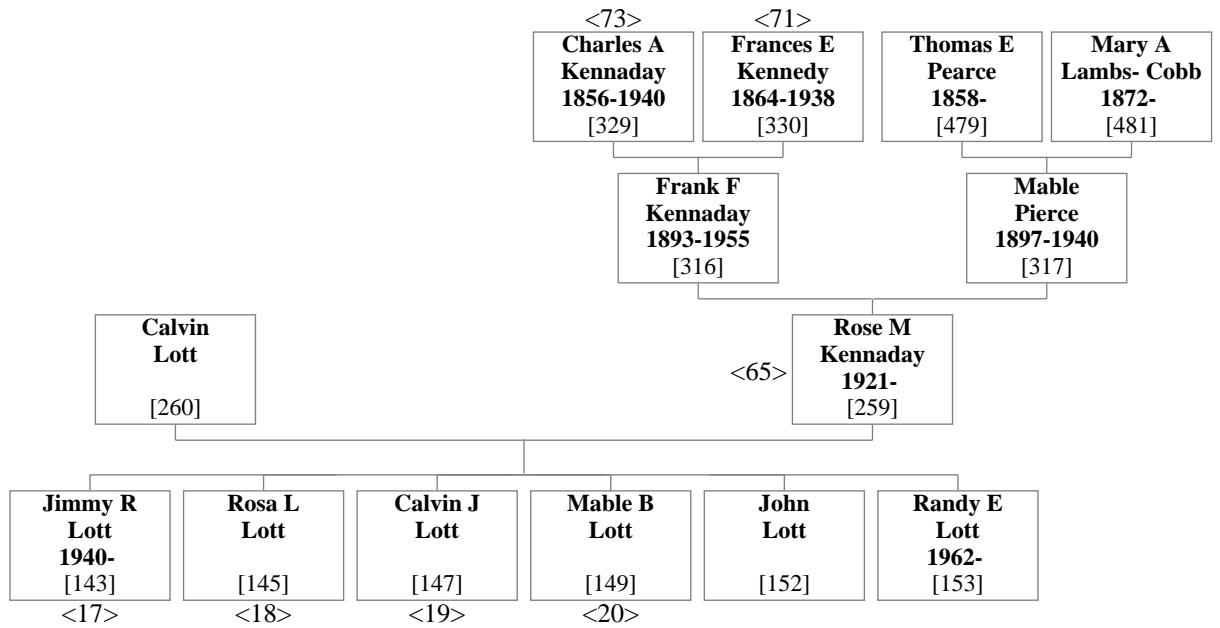
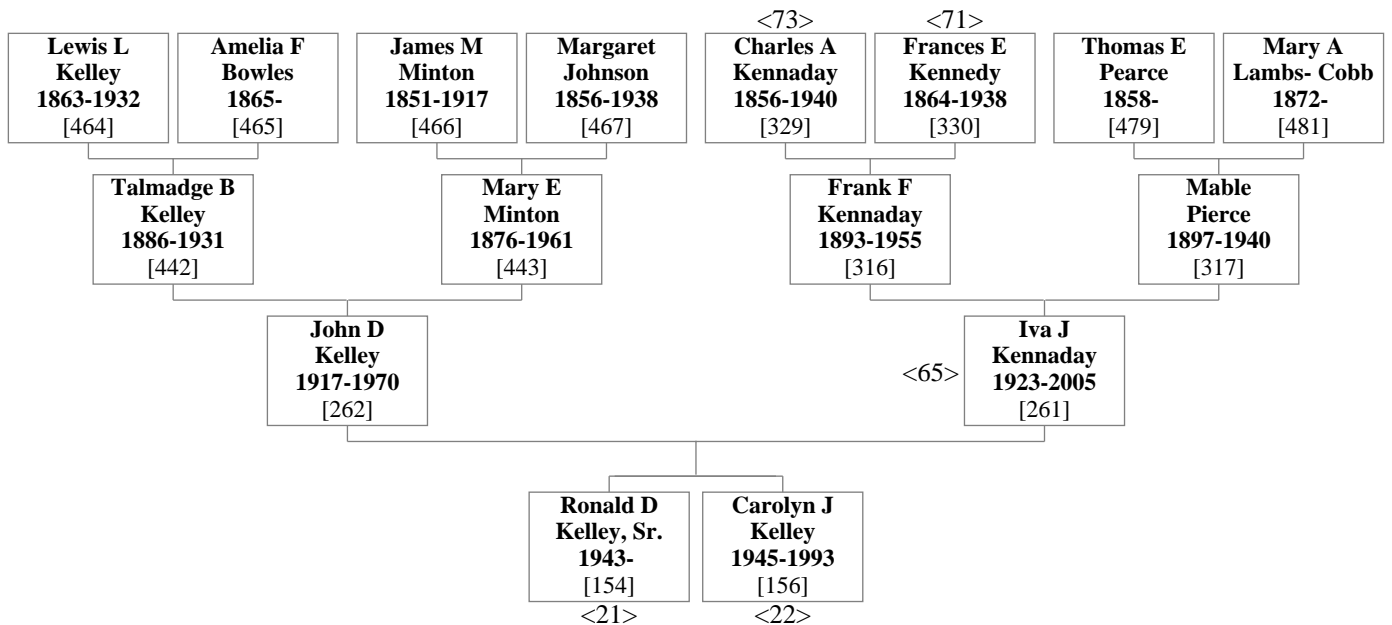
47. Calvin Lott & Rose Marie Kennaday**48. John David Kelley & Iva June Kennaday**

49. Gordon Johnson & Bonnie Jean Kennaday

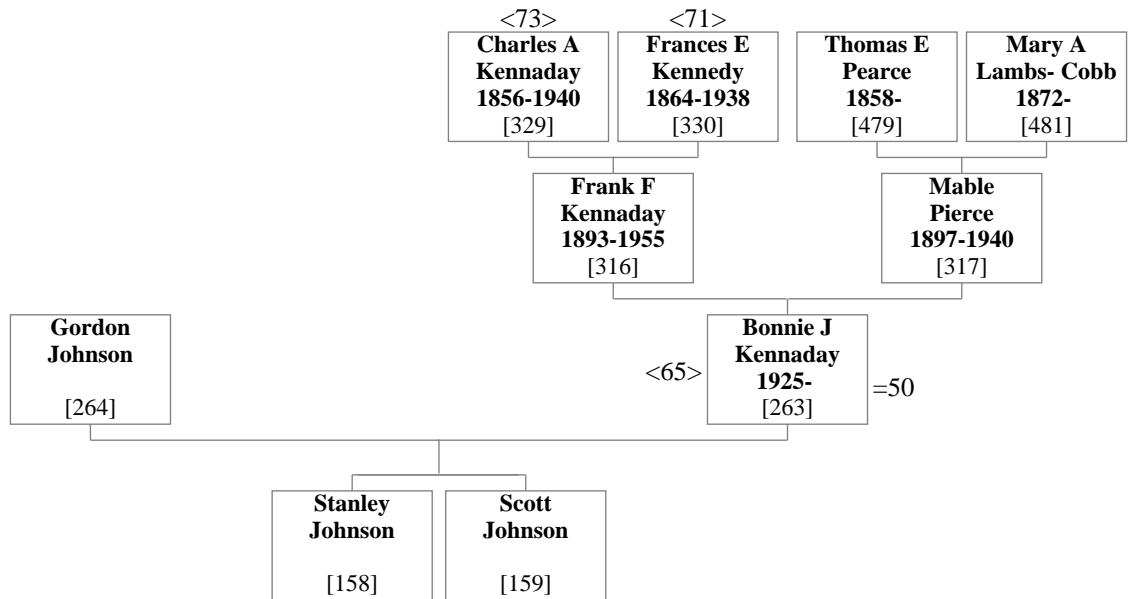

50. James Martin Marier & Bonnie Jean Kennaday

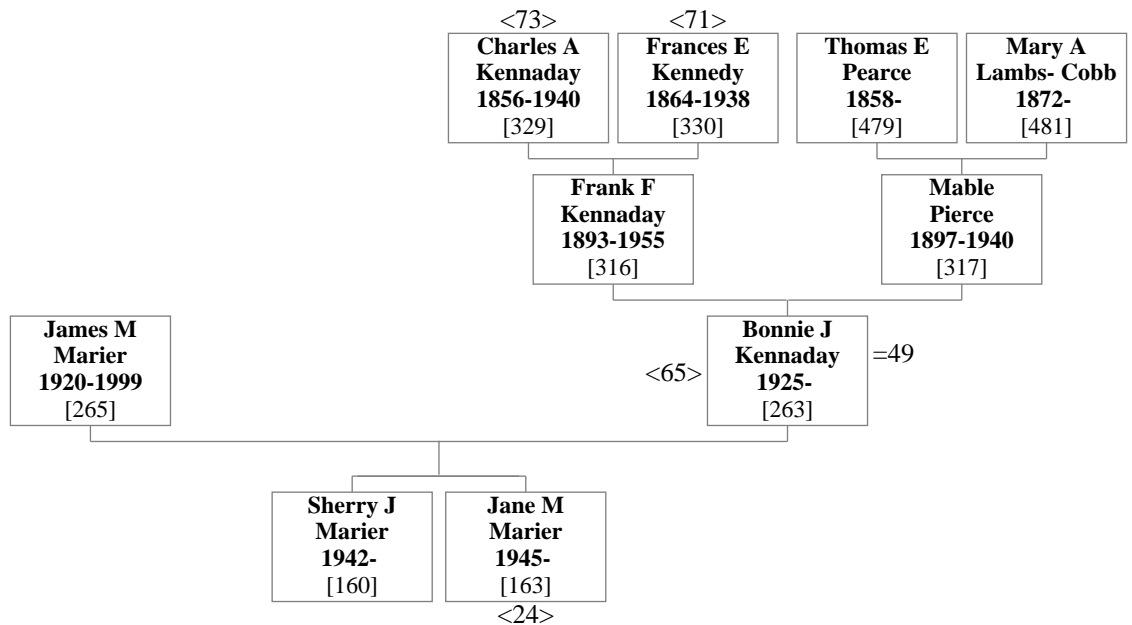

51. Lincoln Frank Kennaday & Joan Olivia Debernardi

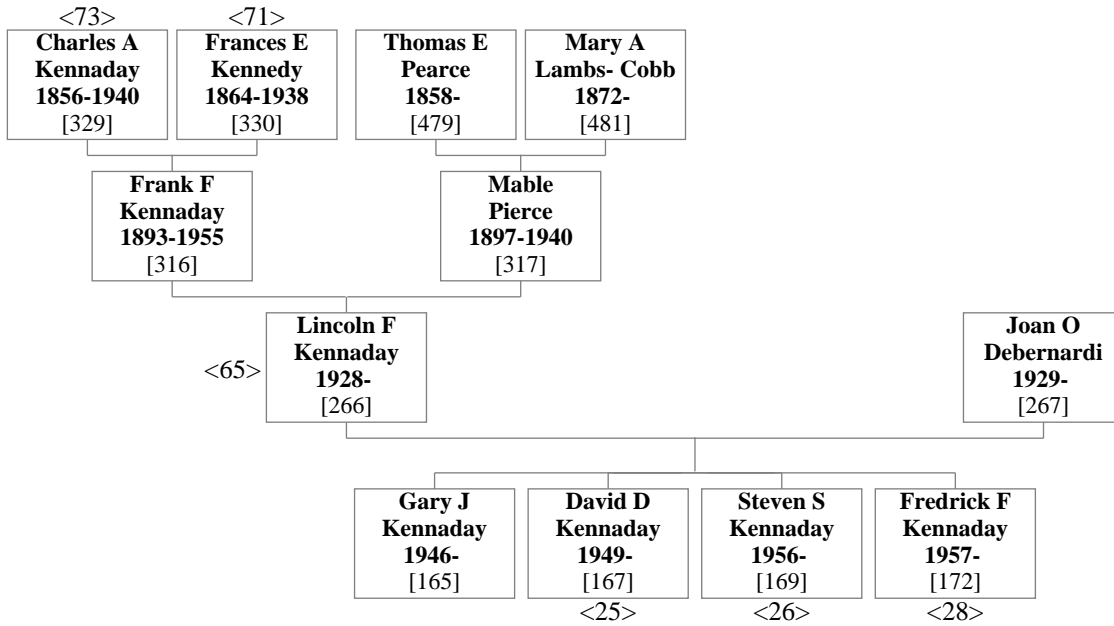

52. Bruce Douglas Whitman & Frances Amonda Davidson

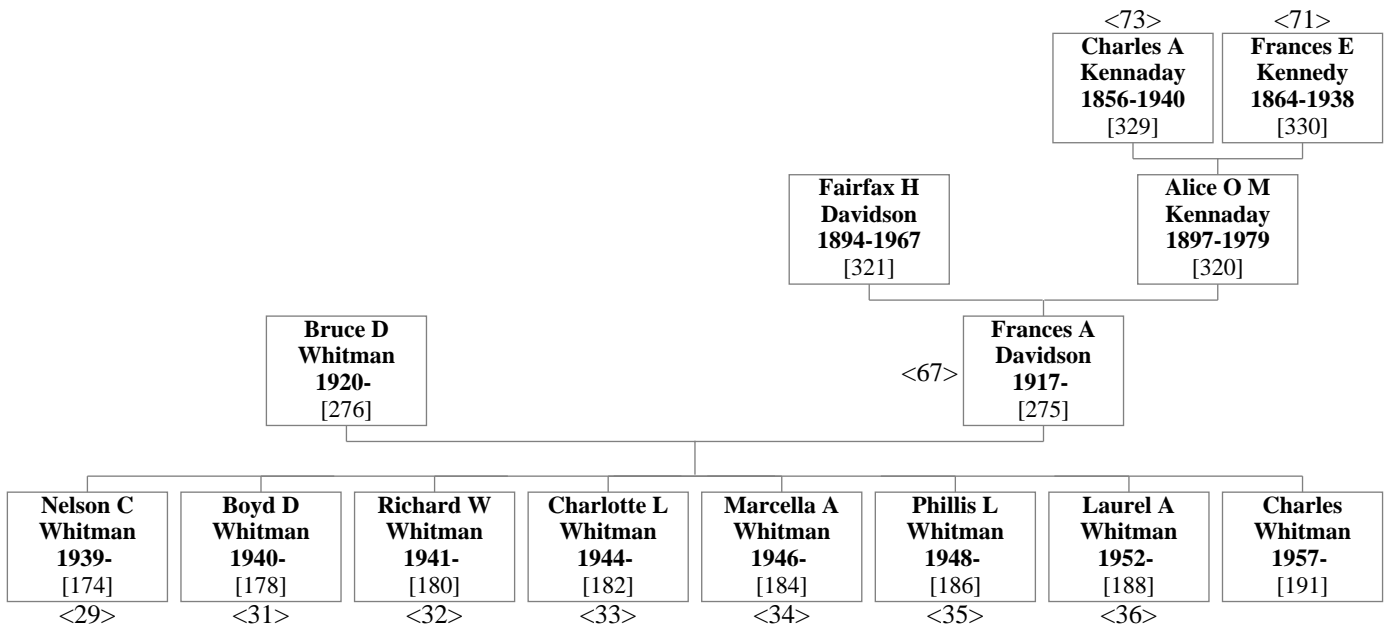

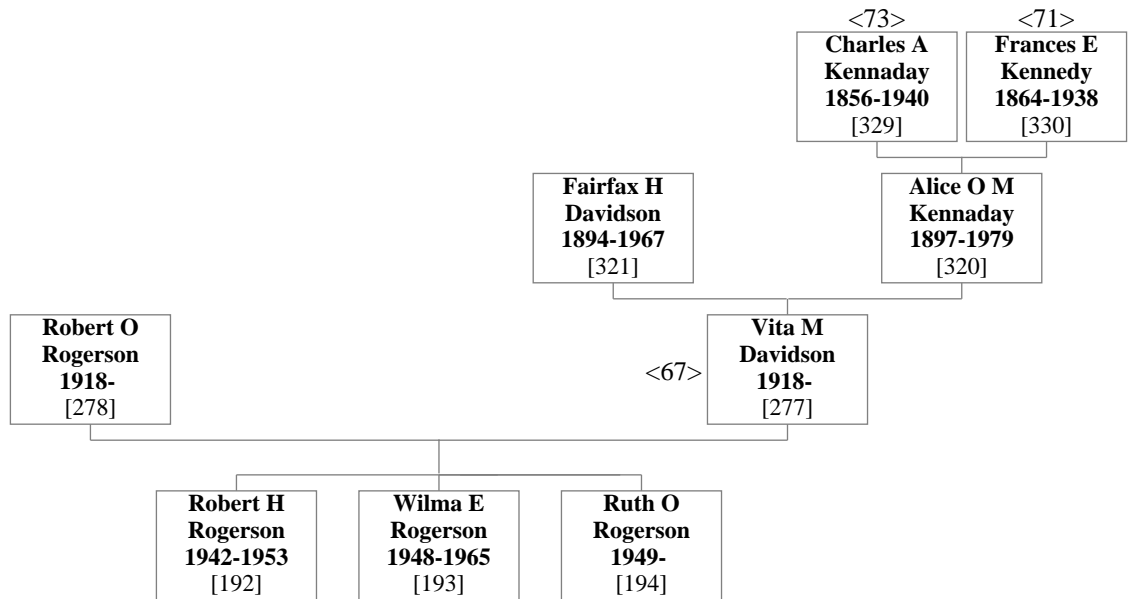
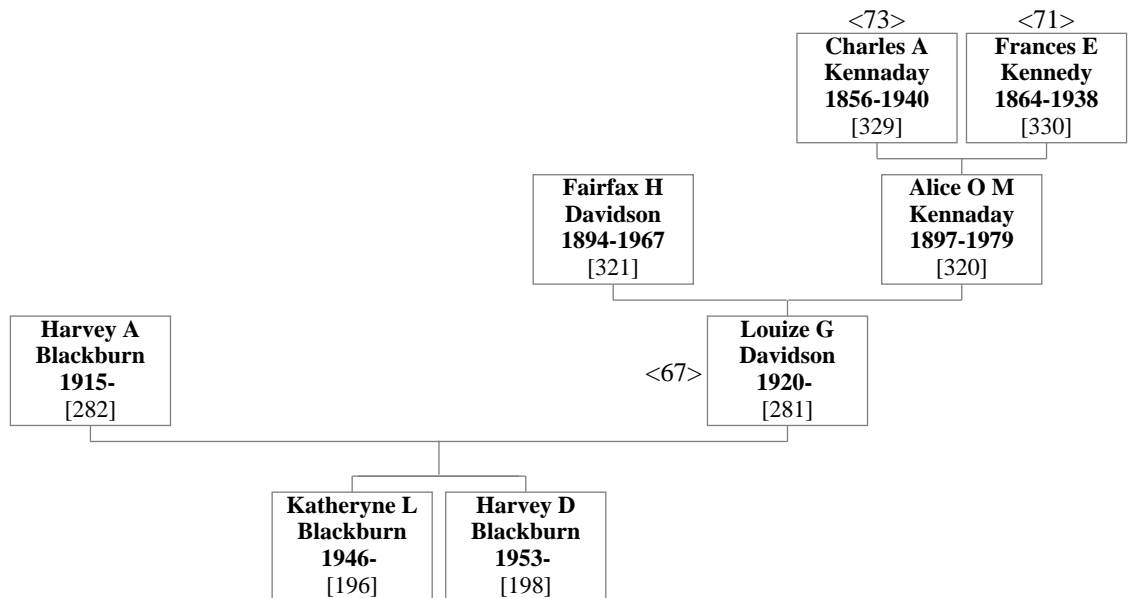
53. Robert Orrin Rogerson & Vita Maude Davidson**54. Harvey Alton Blackburn & Louize Gertrude Davidson**

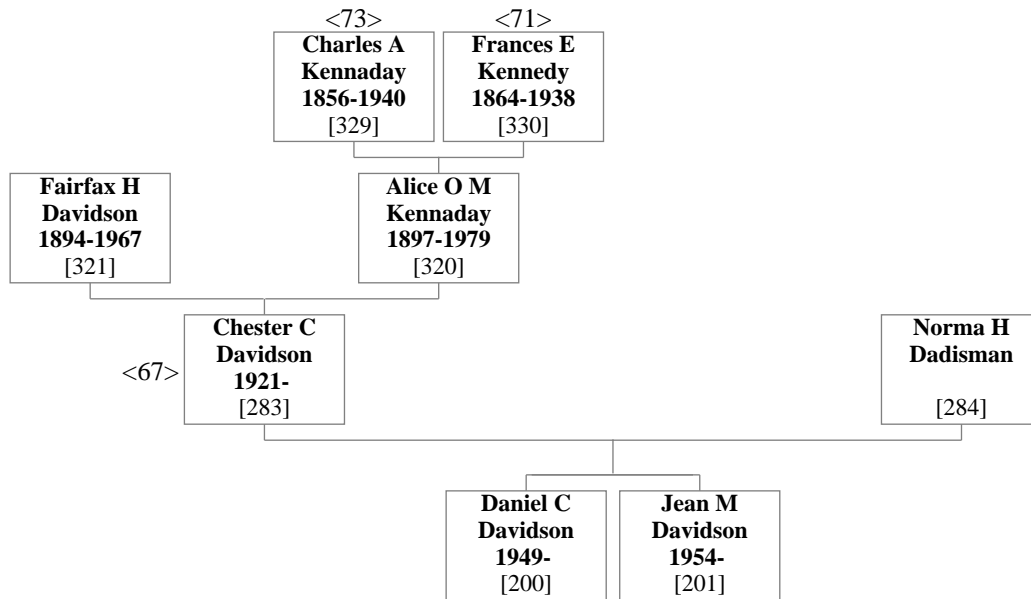
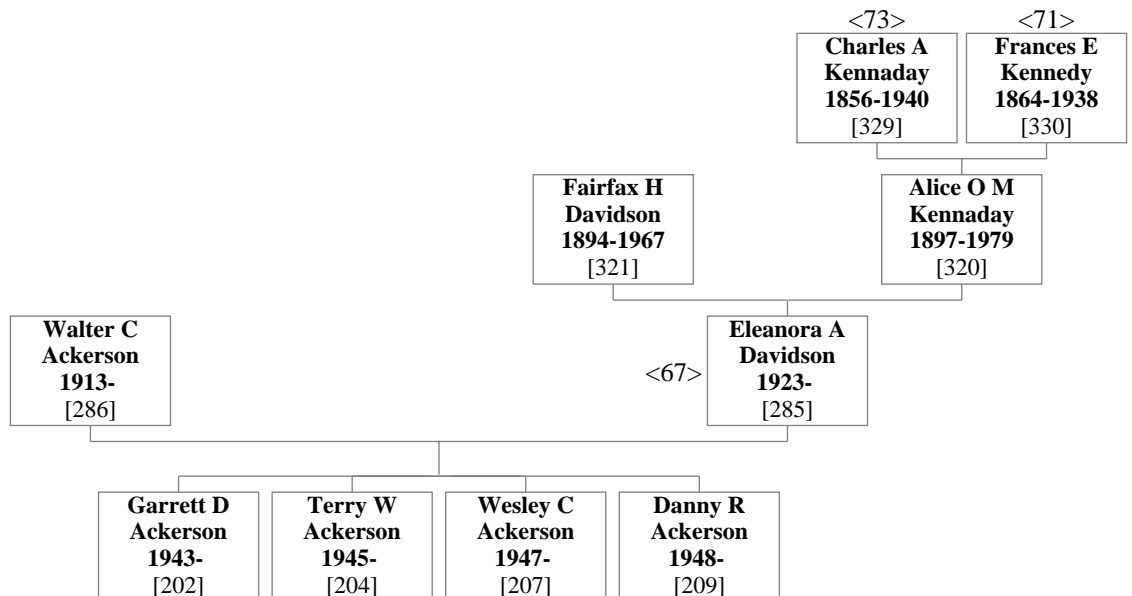
55. Chester Clark Davidson & Norma Hilda Dadisman**56. Walter Cecil Ackerson & Eleanora Alice Davidson**

57. Charles Daniel Davidson & Earlene Dee Noller

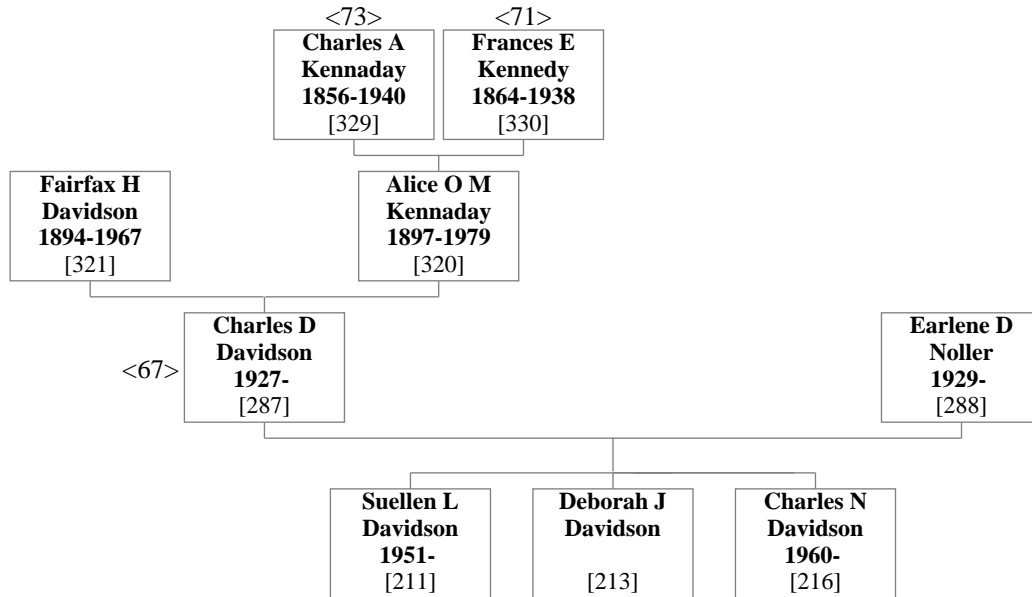

58. David Debernardi Harned & Myrtle Rae Davidson

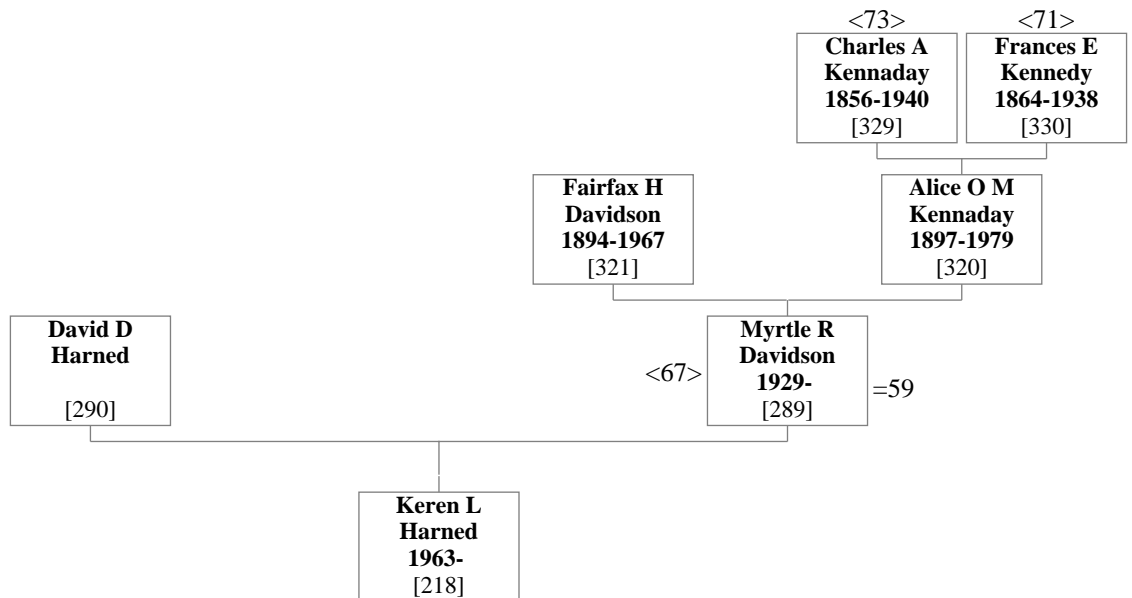

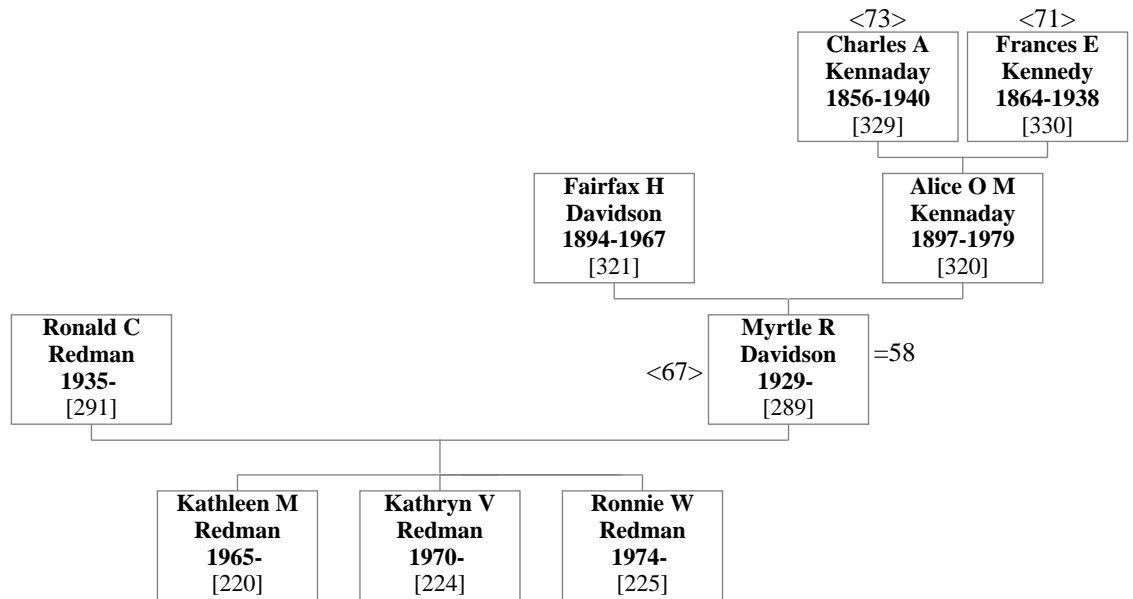
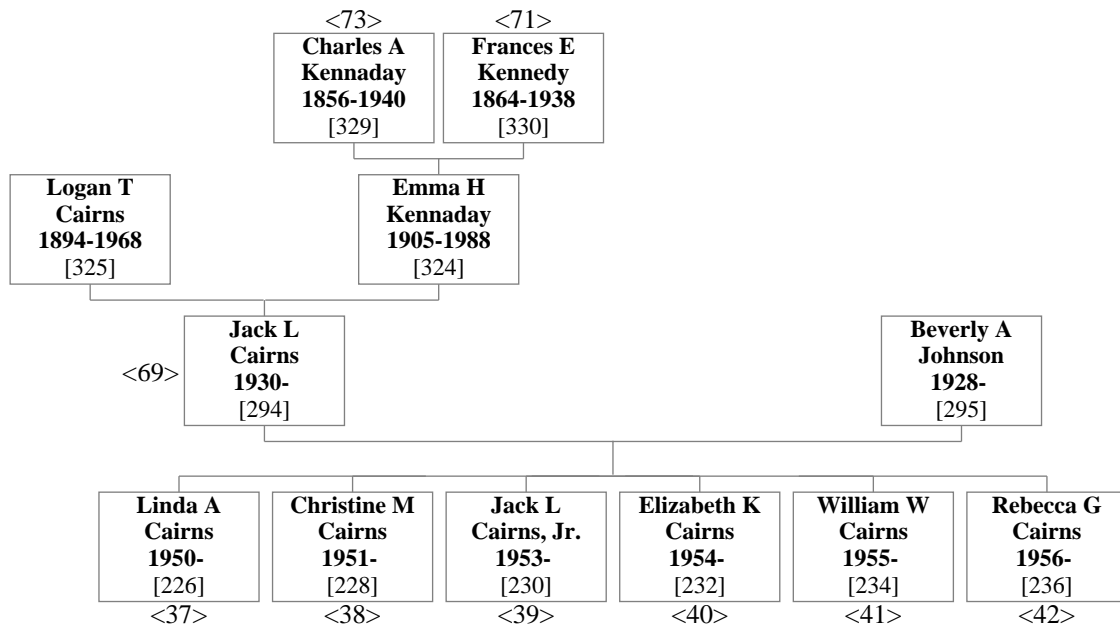
59. Ronald Clark Redman & Myrtle Rae Davidson**60. Jack Lavoy Cairns & Beverly Ann Johnson**

61. Albert Norman Wilson & Margaret Faunita Cairns

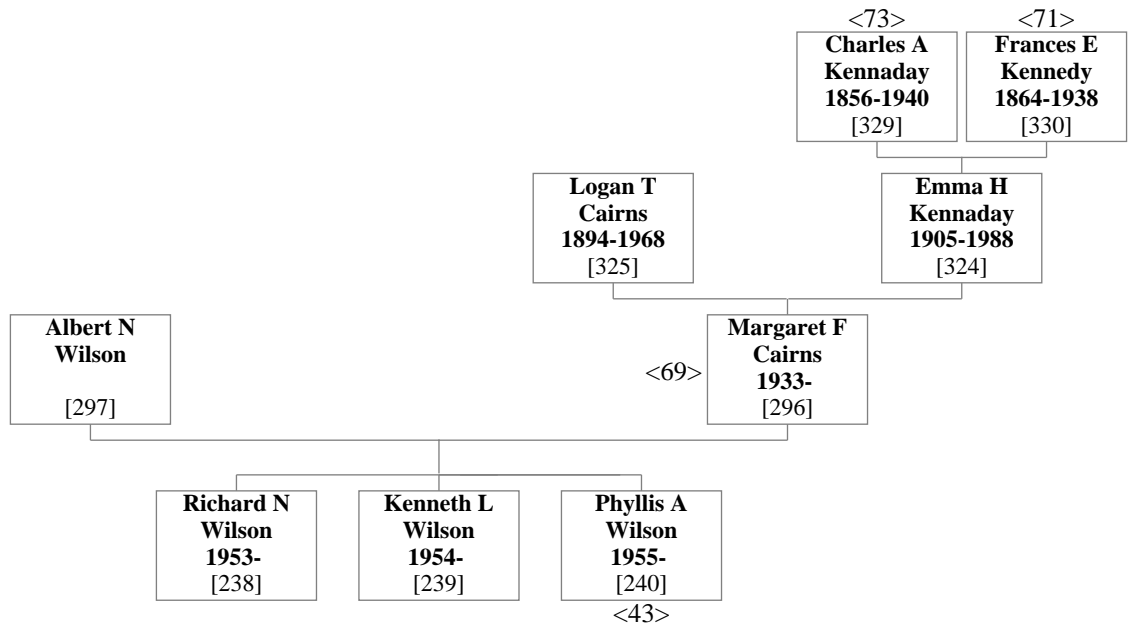

62. Craig Martin Schmeling & Judy Ann Cairns

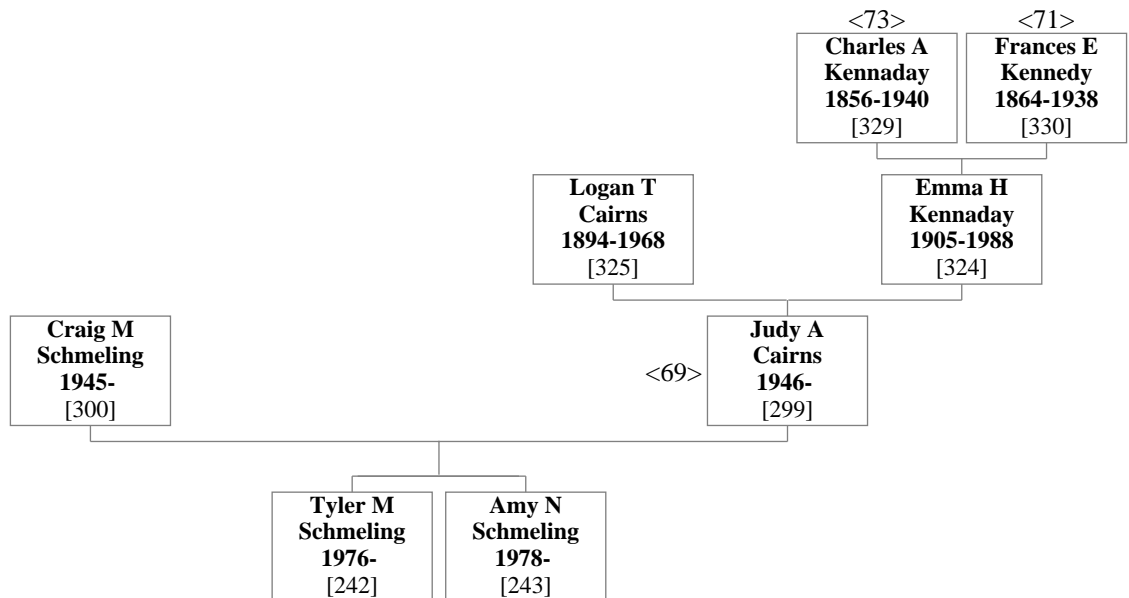

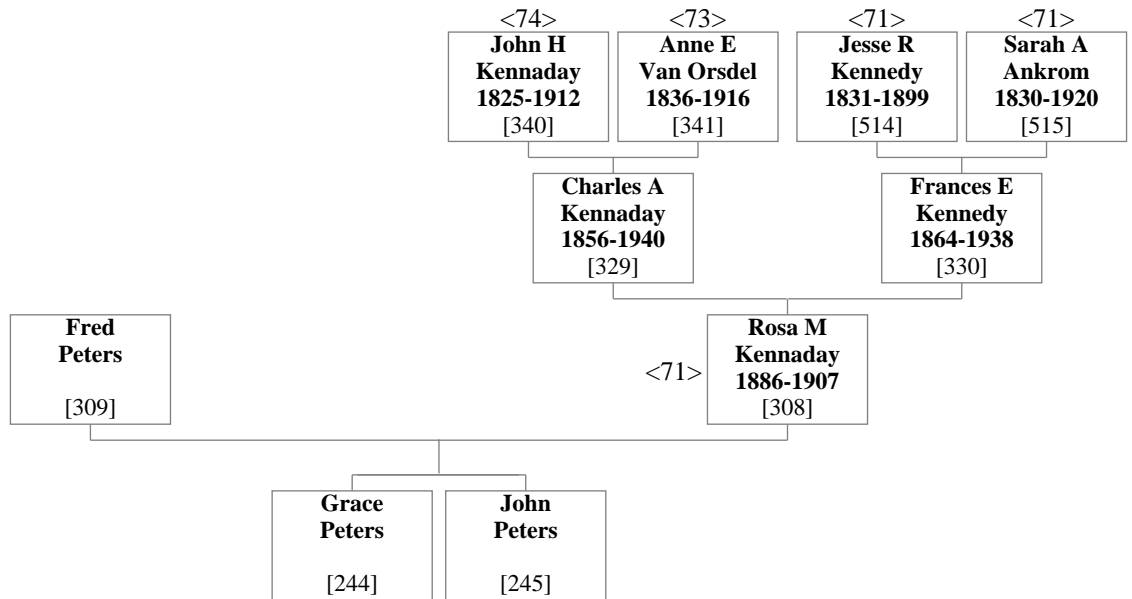
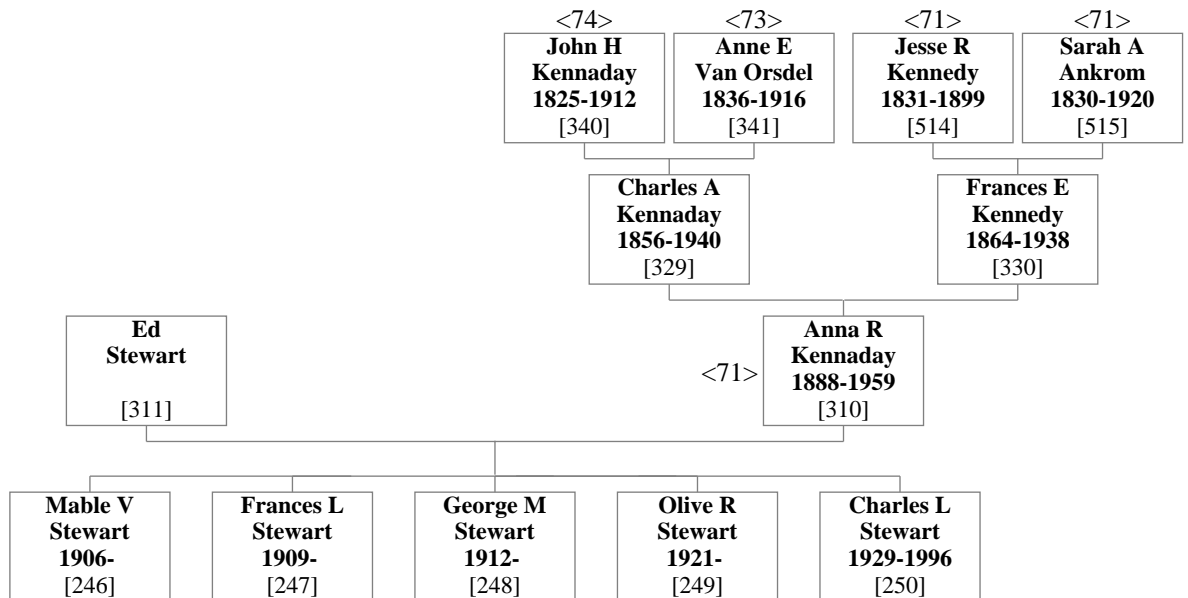
63. Fred Peters & Rosa Marie Kennaday**64. Ed Stewart & Anna Ruth Kennaday**

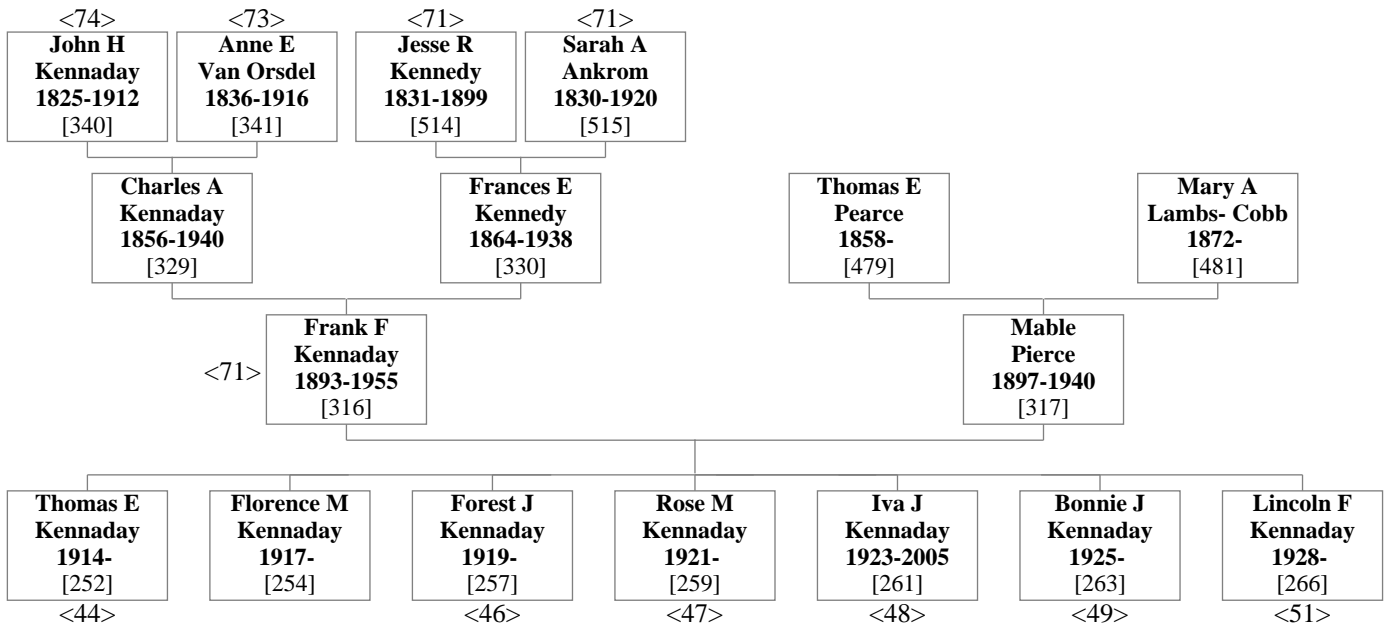
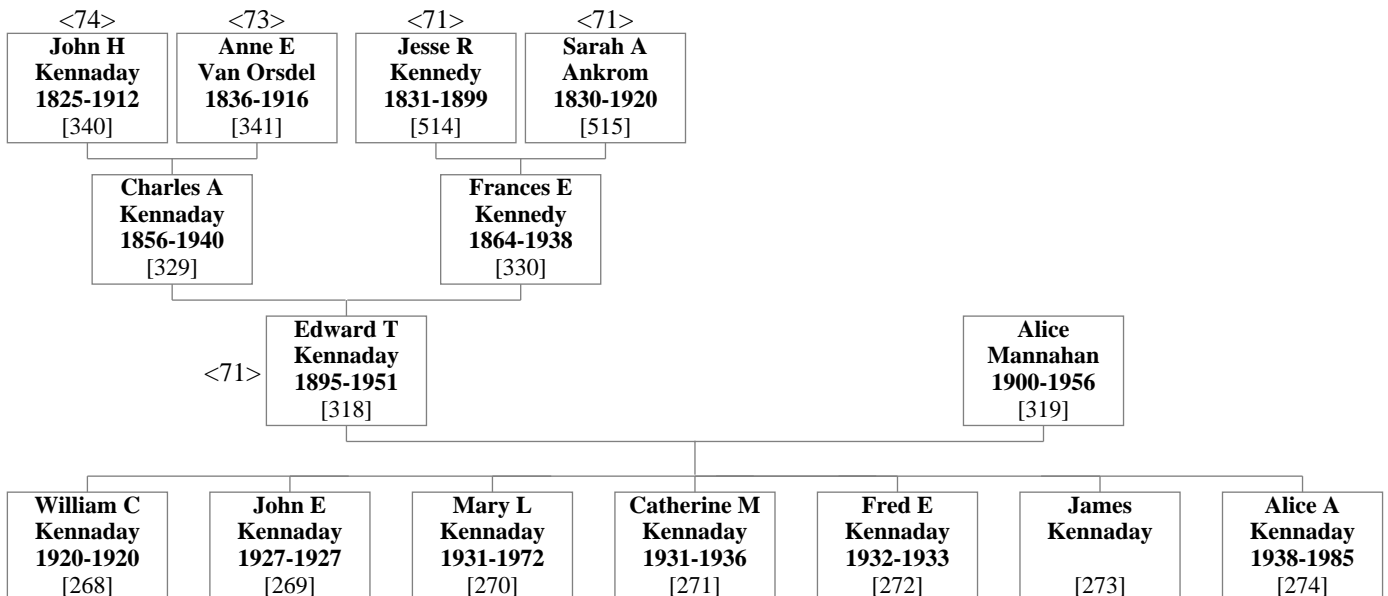
65. Frank Forest Kennaday & Mable Pierce**66. Edward Thomas Kennaday & Alice Mannahan**

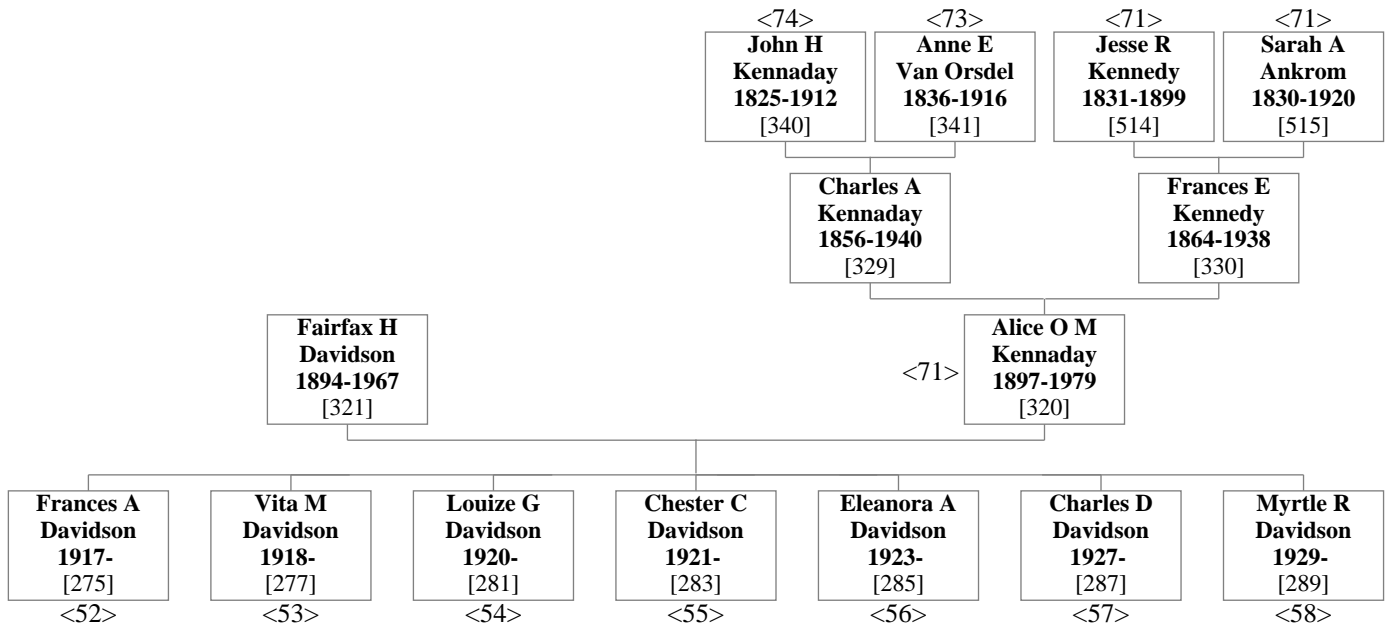
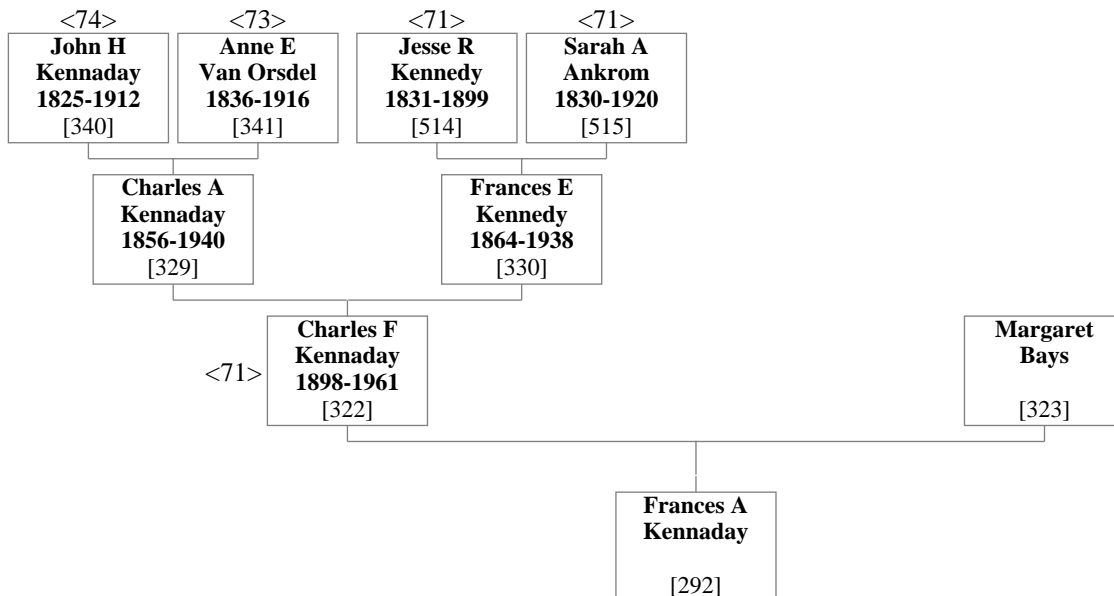
67. Fairfax Harry Davidson & Alice Oda May Kennaday**68. Charles Fredrick Kennaday & Margaret Bays**

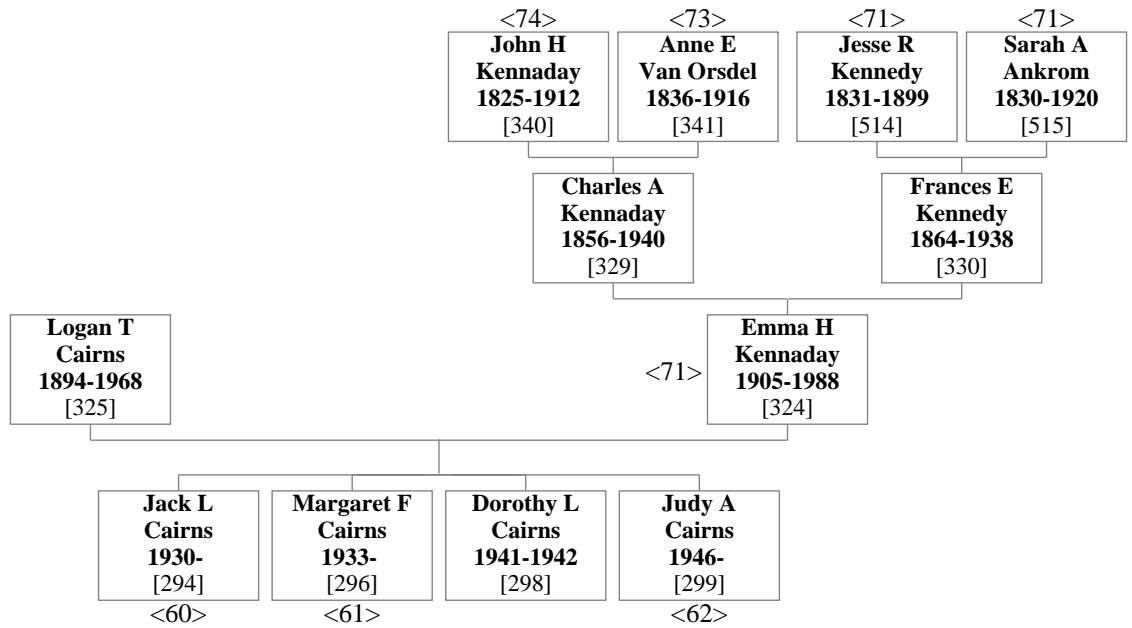
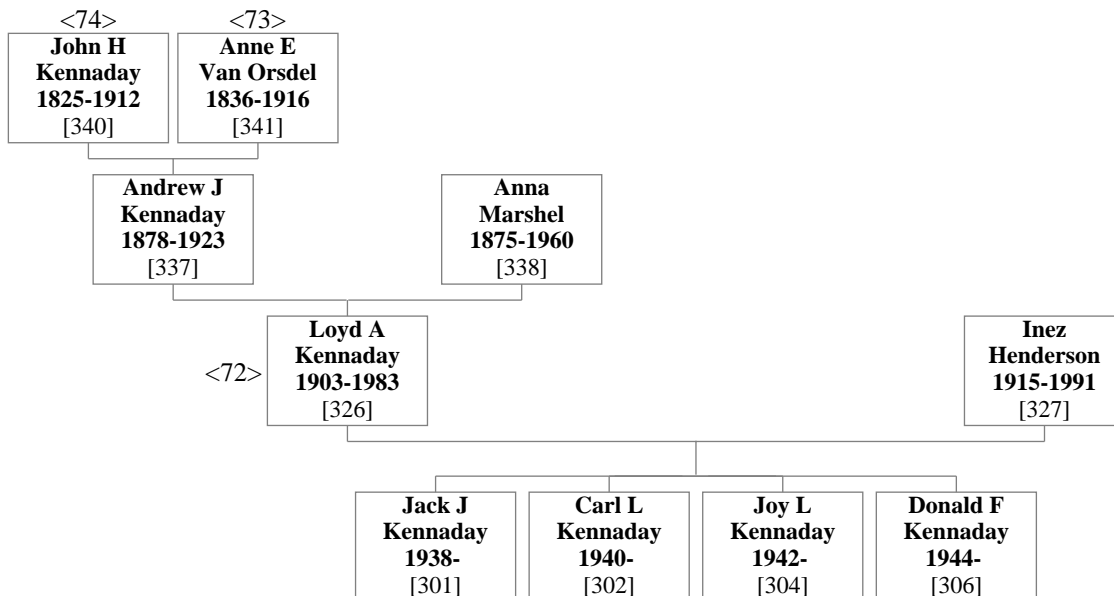
69. Logan Turner Cairns & Emma Helen Kennaday**70. Loyd Andrew Kennaday & Inez Henderson**

71. Charles Alonzo Kennaday & Frances Elizabeth Kennedy

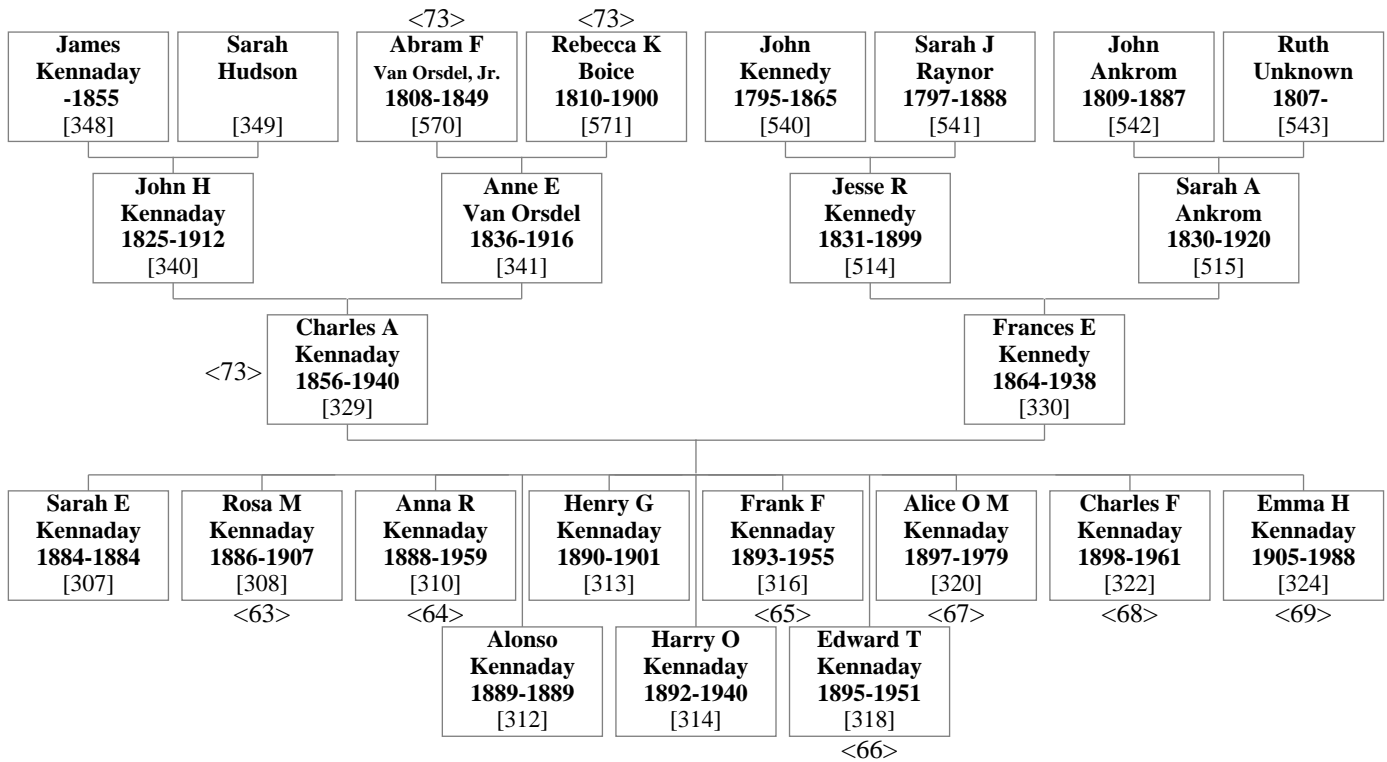

72. Andrew Jackson Kennaday & Anna Marshal

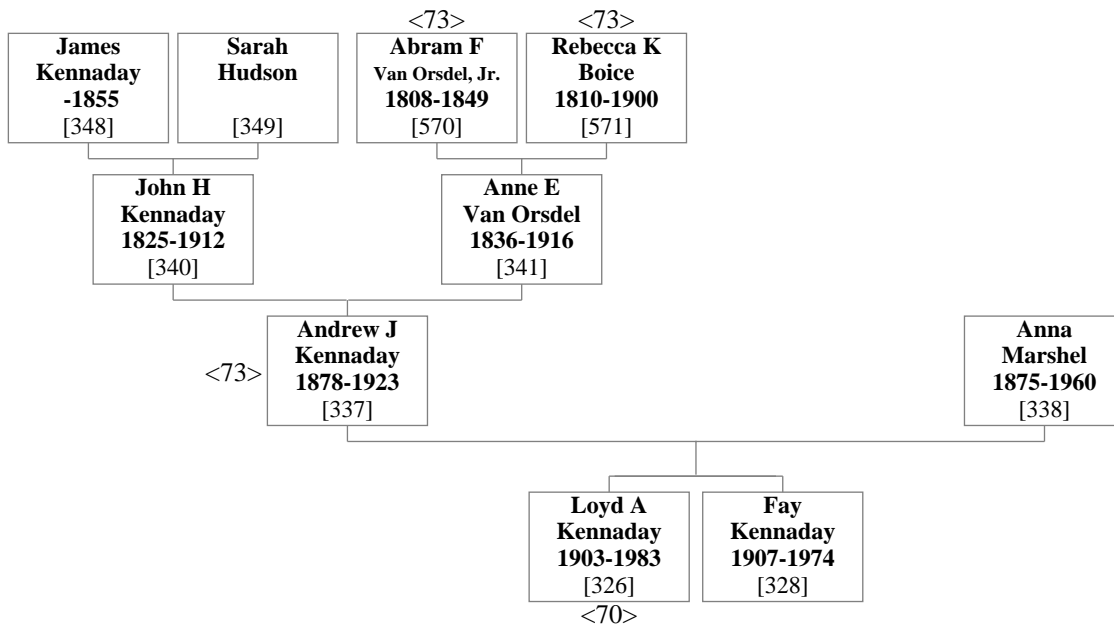

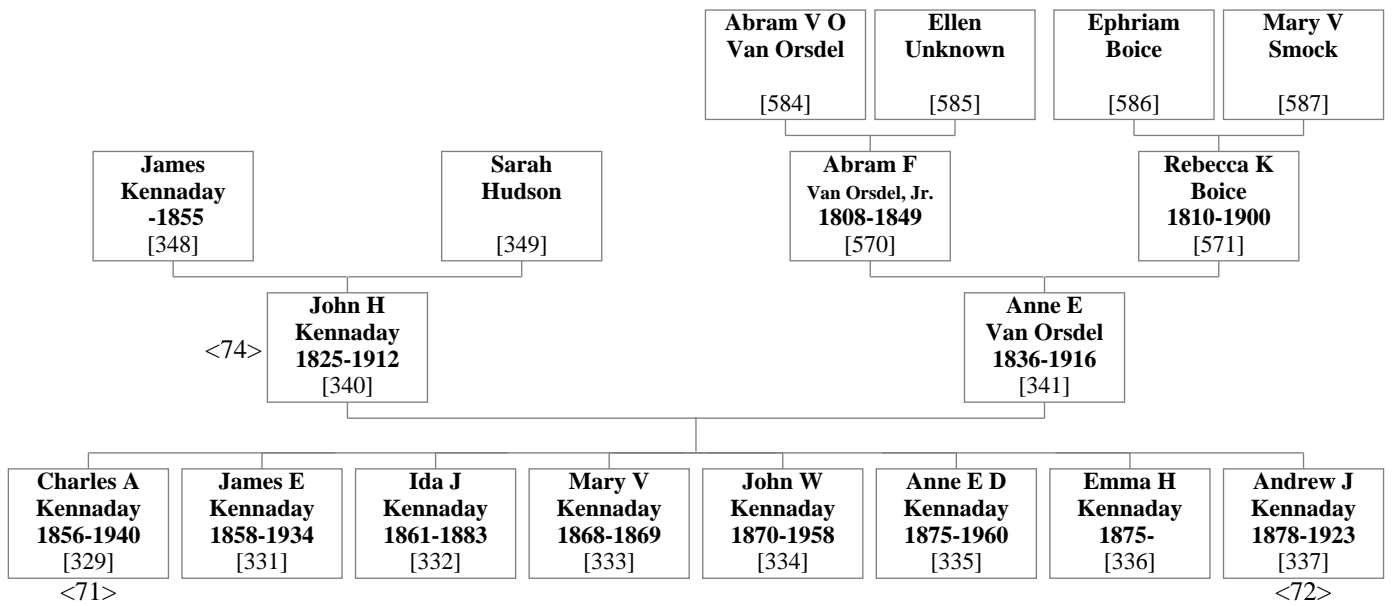
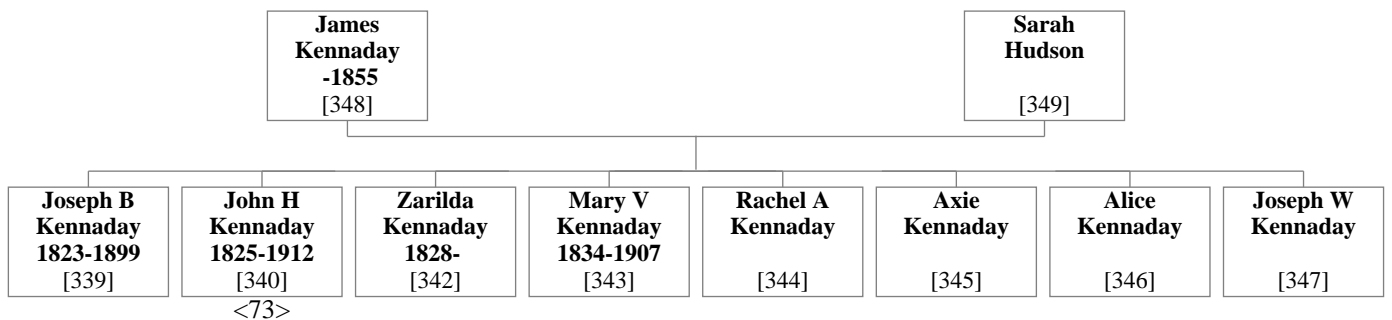
73. John Hudson Kennaday & Anne Elizabeth Van Orsdel**74. James Kennaday & Sarah Hudson**

15. INDEX OF PLACES

1951

Birth of Rita Dianne Rhoads¹⁶⁶.

AD RICHEYS HOME IN MYERS STATION

Death of Lewis Lute Kelley⁴⁶⁴ on 25 July 1932.

CARLISLE KENTUCKY, CARLISLE CEMETARY

Burial of John David Kelley²⁶².

COLORADO, DENVER

Marriage of Thomas Earl Pearce⁴⁷⁹ and Mary Adele Lambs- Cobb⁴⁸¹.

Birth of Alice Pearce⁴⁷⁷ on 28 December 1893.

Birth of Mable Pierce³¹⁷ on 5 January 1897.

CREMATION: ASHES ON GRAVE OF MELONY JO CURTIS DAUGHTER

Burial of Carolyn June Kelley¹⁵⁶.

ENGLAND, LONDON

Birth of James Phipps⁴⁸⁰.

Birth of Thomas Earl Pearce⁴⁷⁹ on 6 June 1858.

ILLINOIS, MACON, BOODY

Birth of James Franklin Kennedy⁵⁰⁷ on 15 November 1866.

Birth of William Edson Kennedy⁵⁰⁹ on 15 October 1868.

INDIANA, INDIANAPOLIS, WASHINGTON PARK CEMETERY

Burial of Ronald David Kelley, Jr.⁵⁸.

IRELAND, DUBLIN

Birth of James Kennaday³⁴⁸.

Birth of John Kennedy⁵⁴⁰ on 9 January 1795.

KENNADAY RANCH

Burial of Anne Elizabeth Van Orsdel³⁴¹.

KENTUCKY, BRETTHETT

Birth of Millard Gullett³⁷⁷ on 11 August 1883.

KENTUCKY, CARLISLE, CARLISLE CEMETARY

Burial of Iva June Kennaday²⁶¹.

KENTUCKY, CARLISLE, CEMETERY, CARLISLE

Burial of Melony Jo Curtis⁶⁹.

KENTUCKY, COUNTY, NICHLOS

Birth of Lewis Lute Kelley⁴⁶⁴ on 5 February 1863.

KENTUCKY, VANDERVILL

Birth of Talmadge Blane Kelley⁴⁴² on 12 July 1886.

MISSOURI, MACON

Birth of Mary Adele Lambs- Cobb⁴⁸¹ on 24 September 1872.

NICARAQUA, MANAQUA

Birth of Caitlin Arlena Boyd¹ in 1992.

NOBEL

Marriage of Jonn Kennedy⁵²² and Lydia Jarvis⁵²³ on 6 October 1861.

OHIO

Marriage of Jesse Rufus Kennedy⁵¹⁴ and Sarah Ann Ankrom⁵¹⁵ on 11 December 1851.

OREGON

Birth of Todd Kennaday³³ on 5 May 1960.

PENNSYLVANIA USA, GREEN, WAYNESBURG

Birth of Sarah Jane Raynor⁵⁴¹ on 10 October 1797.

Birth of James Leighton Kennedy⁵²⁰ on 10 November 1826.

PENNSYLVANIA USA, GREEN, WANYNESBURG

Birth of Jacob Kennedy⁵¹⁹ on 10 November 1826.

TENNESSE

Birth of Cristian Hunnicutt⁵³.

TENNESSEE

Marriage of James M Minton⁴⁶⁶ and Margaret Johnson⁴⁶⁷.

TEXAS, ANTONIO

Marriage of Thomas Eugene Kennaday¹²⁸ and Janice Benson¹²⁹ in 1960.

USA AT CHURCH OF CRIST, KANSAS, CHAUAUQUA, CEDARVALE

Marriage of Charles Alonzo Kennaday³²⁹ and Frances Elizabeth Kennedy³³⁰ on 11 November 1883.

USA, ALABAMA, HUNTSVILLE

Birth of Donna Denice Thompson³⁶¹ on 6 January 1964.

Death of Donna Denice Thompson³⁶¹ on 18 February 1964.

USA, ARIZONA, ORANGE, PHOENIX

Birth of Joyce Ellen Jorgensen³⁴ in 1962.

USA, CALAFORINA, HUMBOLDT, BLUE LAKE

Birth of Olive Ruth Stewart²⁴⁹ in 1921.

Birth of Charles Leroy Stewart²⁵⁰ in 1929.

USA, CALAFORINA, ORANGE, ANAHEIM

Birth of Adam Malaki Kennaday⁷ in 1987.

Birth of Aaron Forest Kennaday⁸ in 1990.

USA, CALIFORINA, NAPA, VALLEJO

Birth of Karla Lynn Kennaday²⁶ on 8 July 1961.

Birth of Kathy Kay Kennaday²⁷ in 1962.

USA, CALIFORNIA, LOS ANGELES, BURBANK

Birth of Brigid Ann Young¹⁷³ in 1956.

USA, CALIFORNIA, SAN DIAGO, SAN DIAGO

Birth of Patricia Leigh Kennaday⁸⁰ in 1979.

USA, CALIFORNIA, VAN NUYS

Birth of Catherine Susan Lavelle¹⁷⁰ in 1956.

USA, CHEROKEE NATION

Birth of Mary V Kennaday³³³ on 12 January 1868.

USA, COLORADO, ADAMS, DENVER

Birth of Frances Amonda Davidson²⁷⁵ in 1917.

USA, COLORADO, DENVER, DENVER

Marriage of Logan Turner Cairns³²⁵ and Emma Helen Kennaday³²⁴ on 3 December 1925.

USA, COLORADO, ELPASO, COLORADO SPRINGS

Birth of Ronald Otis Page²²⁷ in 1950.

USA, COLORADO, MOFFAT, CRAIG

Birth of Jeremy Alan Hansen¹¹² in 1975.

USA, COLORADO, PUEBLO

Birth of Ronald David Kelley, Sr.¹⁵⁴ on 10 September 1943.

USA, COLORADO, SUPERIOR

Birth of Gladys Eleanor Ream²⁵³ in 1914.

USA, FLORIDA, PASCO, HOLIDAY

Death of Virginia Ruth Gullett³⁷⁴ on 21 January 2007.

USA, IDAHO, BONNEVILLE, IDAHO FALLS

Birth of Aaron Wayne Hansen¹¹³ in 1976.

Birth of Michael Brent Hansen¹¹⁴ in 1979.

Birth of Amy Nicole Hansen¹¹⁵ in 1981.

Birth of Dorci Kae Cairns¹¹⁷ in 1983.

Birth of Jacob Karl Hansen¹¹⁶ in 1983.

Birth of Jace William Cairns¹¹⁸ in 1988.

Birth of Brindi Michelle Cairns¹¹⁹ in 1991.

USA, ILLINOIS, MCLEAN, LEXINGTON

Birth of James Edward Kennaday³³¹ on 15 July 1858.

Birth of Ida Jane Kennaday³³² on 4 April 1861.

Birth of Anne E D Kennaday³³⁵ on 29 April 1875.

USA, INDIANA, INDIANAPOLIS

Marriage of Cristian Hunnicutt⁵³ and Lisa June Kelley⁵² on 13 February 1982.

Birth of Christian David Hunnicutt⁹ on 10 January 1983.

Marriage of Gregory Wert⁵⁷ and Anna Carol Kelley⁵⁶ on 28 May 1983.

Death of Iva June Kennaday²⁶¹ on 16 March 2005.

USA, INDIANA, KNOX

Birth of James H Van Orsdel⁵⁵³ on 11 February 1830.

Birth of Mary B Van Orsdel⁵⁵⁵ on 21 June 1834.

Birth of Anne Elizabeth Van Orsdel³⁴¹ on 1 August 1836.

USA, INDIANA, MARION, INDIANAPOLIS

Birth of Norman Perry Curtis, Jr.⁶⁷ on 28 August 1966.

Birth of Melony Jo Curtis⁶⁹ on 14 January 1970.

Death of Melony Jo Curtis⁶⁹ on 8 December 1970.

Birth of David Earl Curtis⁷² on 17 April 1973.

Birth of Mercedes Curtis¹⁷ in August 1994.

Birth of Savanna June Curtis¹⁸ on 14 June 1995.

Death of Ronald David Kelley, Jr.⁵⁸ on 15 September 1997.

USA, KANSAS, CHAUTAUQUA, CEADER VALE

Death of Jesse Rufus Kennedy⁵¹⁴ on 7 August 1899.

USA, KANSAS, CHAUTAUQUA, CEDER VALE

Birth of George Washington Kennedy⁵¹⁰ on 11 October 1870.

Birth of Sarah Jane Kennedy⁵¹² on 11 December 1872.

Birth of Andrew Jackson Kennaday³³⁷ on 15 July 1878.

Birth of Sarah Elizabeth Kennaday³⁰⁷ on 1 November 1884.

Birth of Jesse Rufus Kennedy⁴⁸⁸ on 17 May 1885.

Birth of Rosa Marie Kennaday³⁰⁸ on 22 January 1886.

USA, KANSAS, CHAUTAUQUA, CEDER VALE (continued)

- Birth of Fredrick Fay Kennedy⁴⁹⁰ on 21 January 1888.
- Birth of Anna Ruth Kennaday³¹⁰ on 30 January 1888.
- Birth of Alonso Kennaday³¹² on 4 April 1889.
- Birth of Sadie Bell Kennedy⁴⁹¹ on 2 January 1890.
- Birth of Henry George Kennaday³¹³ on 11 May 1890.
- Birth of Lillie Irene Kennedy⁴⁹³ on 4 May 1906.
- Death of Sarah Ann Ankrom⁵¹⁵ on 29 March 1920.
- Death of Anna Ruth Kennaday³¹⁰ on 6 November 1959.
- Birth of Clarence Bland Kennedy⁴⁹⁵ on 9 April 1980.

USA, KANSAS, COWLEY, WINDFIELD

- Birth of Emma H Kennaday³³⁶ on 10 September 1875.

USA, KENTUCKY, BOONE

- Marriage of John Hudson Kennaday³⁴⁰ and Anne Elizabeth Van Orsdel³⁴¹ on 30 August 1855.

USA, KENTUCKY, BOURBON

- Birth of Abram Van Orsdel⁵⁶⁴ on 31 December 1845.
- Birth of Edward S (Pete) Fitzpatrick³⁷² on 8 July 1916.
- Death of Edward S (Pete) Fitzpatrick³⁷² on 8 November 1978.

USA, KENTUCKY, BOURBON, PARIS

- Birth of Betty Carol Fitzpatrick¹⁵⁵ on 14 April 1947.

USA, KENTUCKY, CARLISLE

- Birth of Dorthy Mae Kelley⁴⁰⁷ on 3 December 1932.
- Birth of Eugene Kelley⁴⁰⁹ on 25 April 1935.
- Birth of Juanita Kelley⁴¹¹ on 15 March 1937.
- Birth of Mary Elizabeth Kelley⁴¹⁴ on 2 January 1939.
- Birth of Wanda Lou Kelley⁴¹⁶ on 22 February 1942.
- Birth of Carolyn June Kelley¹⁵⁶ on 8 February 1945.
- Birth of Cristine Faye Kelley⁴¹⁸ on 9 December 1945.
- Birth of Brenda Jane Kelley⁴²¹ on 25 August 1951.
- Birth of James Luther Kelley, Jr.⁴²² on 14 February 1953.
- Birth of Bobby Gene Kelley³⁸⁵ on 8 August 1954.
- Birth of Freddie Warren Kelley⁴²³ on 24 September 1954.
- Birth of Donnie Lee Kelley⁴²⁴ on 25 November 1955.
- Death of James Luther Kelley⁴³² on 27 March 1956.
- Death of Freddie Warren Kelley⁴²³ on 4 November 1956.
- Birth of Billy Dean Kelley⁴²⁵ on 9 June 1958.
- Death of Mary Elizabeth Minton⁴⁴³ on 26 January 1961.
- Marriage of Norman Perry Curtis¹⁵⁷ and Carolyn June Kelley¹⁵⁶ on 12 January 1963.
- Marriage of Ronald David Kelley, Sr.¹⁵⁴ and Betty Carol Fitzpatrick¹⁵⁵ on 6 April 1963.
- Birth of Lisa June Kelley⁵² on 18 December 1963.
- Death of John David Kelley²⁶² on 21 April 1970.

USA, KENTUCKY, CITY POWEL, CLAY

- Death of Rebecca K Boice⁵⁷¹ on 6 April 1900.

USA, KENTUCKY, CLAY

- Birth of Charles Alonzo Kennaday³²⁹ on 8 November 1856.

USA, KENTUCKY, CYNTHIANA

- Birth of James Mickel Asbury⁵⁴.

USA, KENTUCKY, FAYETTE, LEXINGTON

- Birth of Rebecca Ellen Van Orsdel⁵⁵⁷ on 24 February 1839.
- Birth of Melinda Catherine Van Orsdel⁵⁵⁹ on 14 October 1841.

USA, KENTUCKY, FLEMMINGBURG

Marriage of John David Kelley²⁶² and Iva June Kennaday²⁶¹ on 8 August 1948.

USA, KENTUCKY, LEXINGTON

Birth of Ronald David Kelley, Jr.⁵⁸ on 9 June 1966.

Birth of James Mathew Asbury¹⁰ on 28 June 1991.

USA, KENTUCKY, MERCER, HARRISBURG

Birth of Jacob Boice⁵⁷⁶.

Birth of Katie Boice⁵⁷⁴.

Birth of Rebecca K Boice⁵⁷¹ on 16 April 1810.

Marriage of Gideon Wood⁵⁷³ and Mary B Boice⁵⁷² in 1820.

Birth of William George Van Orsdel⁵⁵¹ on 15 December 1827.

Death of Millard Gulett³⁷⁷ on 8 March 1960.

USA, KENTUCKY, NICHLOS, ICARLISLE

Birth of Anita Carol Curtis⁶² on 9 April 1964.

USA, KENTUCKY, NORTHMIDDLE TOWN

Death of Betty Jack Osburn³⁷⁶ in April 1961.

Death of William Allen Fitzpatrick³⁷⁵ on 12 March 1965.

USA, KENTUCKY, OWEN

Birth of Henery George Van Orsdel⁵⁶⁷ on 17 June 1849.

USA, KENTUCKY, RICHMOND

Birth of Virginia Ruth Gulett³⁷⁴ on 23 February 1923.

USA, KENTUCKY, SCOTT, CYNTHIANA

Birth of Sarah E Van Orsdel⁵⁶¹ on 31 August 1843.

Birth of Isabell Van Orsdel⁵⁶⁵ on 1 December 1846.

Marriage of James Mickel Asbury⁵⁴ and Lisa June Kelley⁵² on 26 May 1990.

USA, MISSOURI

Marriage of George Washington Kennedy⁵¹⁰ and Mary Elizabeth Skelton⁵¹¹ on 7 April 1889.

USA, MISSOURI, BARRY, SELIGMAN

Birth of Mary Elizabeth Skelton⁵¹¹ on 14 August 1863.

USA, MISSOURI, GREEN, SPRINGFIELD

Birth of John W Kennaday³³⁴ on 5 November 1870.

USA, MISSOURI, POLK

Death of Nancy Alice Martindale⁵⁰² on 27 August 1952.

USA, NEW JERSEY

Birth of Jacob Scomp⁵⁸⁸.

USA, NEW MEXICO, RIO ARRIBA, EL VADO

Birth of James Martin Marier²⁶⁵ on 22 February 1920.

USA, NEW YORK, YONKERS

Birth of John Ellery Cooper²³⁷ in 1954.

USA, OHIO, CLEVELAND

Birth of James Vencent Boyd²¹ in 1956.

USA, OHIO, GURNSEY

Birth of Jesse Rufus Kennedy⁵¹⁴ on 2 March 1831.

USA, OHIO, JACKSONTOWNSH

Death of John Kennedy⁵⁴⁰ on 10 August 1865.

USA, OHIO, NOBLE

Birth of Emiline Kennedy⁵²⁴ on 9 January 1836.

USA, OHIO, VENTON, ZALESKI

Birth of Frances Elizabeth Kennedy³³⁰ on 19 September 1864.

USA, OHIO, VINTON

Birth of Jonn Kennedy⁵²² on 19 June 1833.

Birth of Rebecca Kennedy⁵²⁸ on 9 April 1845.

Birth of John Ronnie Kennedy⁵⁰¹ on 26 December 1857.

Birth of Andrew Kennedy⁵⁰³ on 20 August 1860.

USA, OHIO, VINTON, ZALESKI

Birth of Samuel Kennedy⁵²⁵ on 28 February 1837.

Birth of Sarah Jane Kennedy⁵²⁶ on 16 June 1840.

USA, OREGON, DOUGLAS, GLIDE

Birth of Joshua Jolin Kennaday⁷⁷ in 1982.

USA, OREGON, DOUGLAS, ROSEBURG

Birth of Joan Olivia Debernardi²⁶⁷ on 30 April 1929.

Birth of Gary Jo Kennaday¹⁶⁵ on 4 March 1946.

Birth of David Debernardi Kennaday¹⁶⁷ on 8 January 1949.

Birth of Paula Jo Smith¹⁶⁸ in 1953.

Birth of Steven Scott Kennaday¹⁶⁹ on 5 March 1956.

Birth of Fredrick Frank Kennaday¹⁷² on 5 May 1957.

Birth of Nicholas Isaiah Kennaday⁷⁴ in 1978.

Birth of Elizabeth Alta Olivia Kennaday⁷⁵ in 1980.

Birth of Anthony Joseph Kennaday⁸¹ in 1981.

Birth of Cristina Dianne Kennaday⁷⁶ in 1982.

USA, ORGAN, JACKSON, MEDFORD

Birth of Randy Eugene Sobo²² on 7 July 1959.

Birth of Teresa Lynn Sobo²⁴ on 19 August 1960.

Birth of Justin Kyle Sobo³ in 1982.

Birth of Julie Erin Sobo⁴ in 1985.

Birth of Tyler Jamison Sobo⁶ in 1987.

Birth of Travis Andrew Sobo⁵ in 1987.

USA, ORGAN, KLAMATH, FALLS, KLAMATH

Birth of Brenda Sue Sobo²⁰ on 22 March 1958.

USA, ORGAND, WASHINGTON, PORTLAND

Birth of August Henry Geppert¹³¹ in 1937.

Birth of Lori Ann Geppert²⁸ on 18 February 1960.

Birth of Judy Arlene Geppert³⁰ in 1962.

Birth of Tommy Duane Geppert³² in 1964.

USA, PENNSYLVANIA, GREEN

Birth of John Ankrom⁵⁴² on 9 August 1809.

Birth of Richard Ankrom⁵²⁹ on 5 February 1827.

Birth of Solomon Ankrom⁵³⁰ on 8 August 1828.

Birth of Sarah Ann Ankrom⁵¹⁵ on 12 September 1830.

Birth of John Ellery Ankrom⁵³¹ on 2 June 1833.

Birth of Martha Ann Ankrom⁵³³ on 4 November 1837.

Birth of William Ankrom⁵³⁴ on 7 April 1840.

Birth of Uriah Ankrom⁵³⁵ on 29 May 1842.

Birth of Elizabeth Ankrom⁵³⁶ on 27 June 1844.

Birth of Miriah Ankrom⁵³⁷ on 28 December 1846.

USA, PENNSYLVANIA, GREEN (continued)

Birth of Clementine Ankrom⁵³⁸ on 21 November 1848.
 Birth of Thomas Ankrom⁵³⁹ on 1 May 1853.

USA, PENNSYLVANIA, GREEN, WANESBURG

Birth of Nancy Kennedy⁵¹⁶ on 1 January 1821.
 Birth of Christine Kennedy⁵¹⁸ on 11 July 1822.

USA, UTAH, CACHE, LOGAN

Birth of Tiffany Anne Cooper¹²⁰ in 1977.
 Birth of Hillary Ranee Cooper¹²² in 1978.

USA, UTAH, IRON, CEDER CITY

Birth of Kae Porter²³⁵ in 1957.

USA, UTAH, SALT LAKE, SALT LAKE CITY

Birth of Triana Marie Campbell¹⁰⁷ in 1978.
 Birth of Holly Ann Campbell¹⁰⁸ in 1980.
 Birth of Eric Raymond Campbell¹⁰⁹ in 1985.

USA, UTAH, WEBER, OGDEN

Birth of Thomas Elliott Page¹⁰⁴ in 1971.

USA, WYOMING, CARBON

Death of Anne Elizabeth Van Orsdel³⁴¹ on 10 February 1916.

USA, WYOMING, CARBON, DEC. 9 1940 AT SARATOGA

Burial of Charles Alonzo Kennaday³²⁹.

USA, WYOMING, CARBON, HANNA

Birth of Beverly Ann Johnson²⁹⁵ in 1928.

USA, WYOMING, CARBON, RAWLINS

Birth of Logan Turner Cairns³²⁵ in 1894.
 Birth of Jack Lavoy Cairns²⁹⁴ in 1930.
 Marriage of Thomas Earl Kennaday²⁵² and Gladys Eleanor Ream²⁵³ on 13 May 1933.
 Birth of Margaret Faunita Cairns²⁹⁶ in 1933.
 Birth of Patty Ray Kennaday¹³⁰ on 3 August 1937.
 Birth of Dorothy Lorraine Cairns²⁹⁸ in 1941.
 Birth of Judy Ann Cairns²⁹⁹ in 1946.
 Birth of Christine Marie Cairns²²⁸ in 1951.
 Birth of Richard Norman Wilson²³⁸ in 1953.
 Birth of Kenneth Logan Wilson²³⁹ in 1954.
 Birth of Elizabeth Kay Cairns²³² in 1954.
 Birth of William Wayne Cairns²³⁴ in 1955.
 Birth of Phyllis Ann Wilson²⁴⁰ in 1955.
 Birth of Rebecca Gay Cairns²³⁶ in 1956.
 Birth of Johnathan Jack Page¹⁰⁵ in 1973.
 Birth of Donald Grant Page¹⁰⁶ in 1975.
 Birth of Kreeta Ann Jebens¹²³ in 1975.
 Birth of Korey Kay Jebens¹²⁴ in 1977.
 Death of Alice Oda May Kennaday³²⁰ on 6 December 1979.
 Birth of Carlie Norman Jebens¹²⁵ in 1979.
 Death of Emma Helen Kennaday³²⁴ on 26 August 1988.

USA, WYOMING, CARBON, SARATOGA

Birth of Harry Otis Kennaday³¹⁴ on 8 October 1892.
 Birth of Frank Forest Kennaday³¹⁶ on 6 November 1893.
 Birth of Edward Thomas Kennaday³¹⁸ on 9 October 1895.
 Birth of Alice Oda May Kennaday³²⁰ on 13 April 1897.
 Birth of Charles Fredrick Kennaday³²² on 30 November 1898.

USA, WYOMING, CARBON, SARATOGA (continued)

- Birth of Alice Mannahan³¹⁹ in 1900.
 Birth of Loyd Andrew Kennaday³²⁶ on 2 August 1903.
 Birth of Emma Helen Kennaday³²⁴ on 8 December 1905.
 Birth of Fay Kennaday³²⁸ on 14 June 1907.
 Birth of Thomas Earl Kennaday²⁵² on 7 July 1914.
 Birth of Florence Mae Kennaday²⁵⁴ on 28 June 1917.
 Birth of Vita Maude Davidson²⁷⁷ in 1918.
 Birth of Forest Jack Kennaday²⁵⁷ on 22 November 1919.
 Birth of Ellen (Dude) Stockwell²⁵⁸ in 1919.
 Birth of Louize Gertrude Davidson²⁸¹ in 1920.
 Birth of William C Kennaday²⁶⁸ in 1920.
 Birth of Rose Marie Kennaday²⁵⁹ on 10 October 1921.
 Birth of Iva June Kennaday²⁶¹ on 13 June 1923.
 Death of Andrew Jackson Kennaday³³⁷ on 8 December 1923.
 Birth of John E Kennaday²⁶⁹ in 1927.
 Birth of Lincoln Frank Kennaday²⁶⁶ on 9 April 1928.
 Birth of Catherine Marie Kennaday²⁷¹ in 1931.
 Birth of Mary Lou Kennaday²⁷⁰ in 1931.
 Birth of Fred E Kennaday²⁷² in 1932.
 Birth of Thomas Eugene Kennaday¹²⁸ on 14 August 1935.
 Marriage of Loyd Andrew Kennaday³²⁶ and Inez Henderson³²⁷ on 23 October 1937.
 Death of Frances Elizabeth Kennedy³³⁰ on 10 June 1938.
 Birth of Jack J Kennaday³⁰¹ on 18 September 1938.
 Birth of Alice Ann Kennaday²⁷⁴ in 1938.
 Death of Mable Pierce³¹⁷ on 27 May 1940.
 Death of Charles Alonzo Kennaday³²⁹ on 6 December 1940.
 Birth of Carl L Kennaday³⁰² on 18 December 1940.
 Birth of Joy L Kennaday³⁰⁴ on 17 April 1942.
 Birth of Donald Fay Kennaday³⁰⁶ on 18 May 1944.
 Death of Anna Marshel³³⁸ on 8 December 1960.
 Death of Inez Henderson³²⁷ on 22 September 1991.

USA, WYOMING, LARAMIE, CHEYENNE

- Death of Harry Otis Kennaday³¹⁴ on 25 April 1940.
 Birth of Amy Nichole Schmeling²⁴³ in 1978.

USA, WYOMING, PLATTE, WEATLAND

- Birth of Tyler Martin Schmeling²⁴² in 1976.

USA, WYOMING, PLATTE, WHITTEMORE

- Birth of Craig Martin Schmeling³⁰⁰ in 1945.

USA, WYOMING, SUBLETTE, BIGPINEY

- Birth of Nelson Chester Whitman¹⁷⁴ in 1939.
 Birth of Boyd David Whitman¹⁷⁸ in 1940.
 Birth of Richard Ward Whitman¹⁸⁰ in 1941.
 Birth of Charlotte Louize Whitman¹⁸² in 1944.

USA, WYOMING, SWEETWATER, ROCK SPRINGS

- Birth of Jack Lavoy Cairns, Jr.²³⁰ in 1953.

VIRGINIA, OLD VIRGINIA

- Birth of Mary Elizabeth Minton⁴⁴³ on 26 August 1876.

WYOMING, 1988 RAWLINS, AUG 30

- Burial of Emma Helen Kennaday³²⁴.

WYOMING, JUNE 13 1938 SARATOGA

Burial of Frances Elizabeth Kennedy³³⁰.

WYOMING, SARATOGA

Burial of Harry Otis Kennaday³¹⁴.

Marriage of Fred Peters³⁰⁹ and Rosa Marie Kennaday³⁰⁸ on 7 March 1904.

Death of Rosa Marie Kennaday³⁰⁸ on 22 July 1907.

16. INDEX OF DATES

- 1795** Birth of John Kennedy⁵⁴⁰ on 9 January, in Dublin, Ireland.
- 1797** Birth of Sarah Jane Raynor⁵⁴¹ on 10 October, in Waynesburg, Green, Pennsylvania USA.
- 1807** Birth of Ruth Unknown⁵⁴³ on 2 April.
- 1808** Birth of Abram F Van Orsdel, Jr.⁵⁷⁰.
- 1809** Birth of John Ankrom⁵⁴² on 9 August, in Green, Pennsylvania, USA.
- 1810** Birth of Rebecca K Boice⁵⁷¹ on 16 April, in Harrisburg, Mercer, Kentucky, USA.
- 1818** Marriage of John Kennedy⁵⁴⁰ and Sarah Jane Raynor⁵⁴¹.
- 1820** Marriage of Gideon Wood⁵⁷³ and Mary B Boice⁵⁷² in Harrisburg, Mercer, Kentucky, USA.
- 1821** Birth of Nancy Kennedy⁵¹⁶ on 1 January, in Wanesburg, Green, Pennsylvania, USA.
- 1822** Birth of Christine Kennedy⁵¹⁸ on 11 July, in Wanesburg, Green, Pennsylvania, USA.
- 1823** Birth of Joseph Bryson Kennaday³³⁹ on 22 February.
- 1825** Birth of John Hudson Kennaday³⁴⁰ on 13 June.
- 1826** Marriage of John Ankrom⁵⁴² and Ruth Unknown⁵⁴³ on 7 May.
Birth of James Leighton Kennedy⁵²⁰ on 10 November, in Waynesburg, Green, Pennsylvania USA.
Birth of Jacob Kennedy⁵¹⁹ on 10 November, in Wanyesburg, Green, Pennsylvania USA.
- 1827** Birth of Richard Ankrom⁵²⁹ on 5 February, in Green, Pennsylvania, USA.
Marriage of Abram F Van Orsdel, Jr.⁵⁷⁰ and Rebecca K Boice⁵⁷¹ on 27 February.
Birth of William George Van Orsdel⁵⁵¹ on 15 December, in Harrisburg, Mercer, Kentucky, USA.
- 1828** Birth of Zarilda Kennaday³⁴² on 16 March.
Birth of Solomon Ankrom⁵³⁰ on 8 August, in Green, Pennsylvania, USA.
- 1830** Birth of James H Van Orsdel⁵⁵³ on 11 February, in Knox, Indiana, USA.
Birth of Sarah Ann Ankrom⁵¹⁵ on 12 September, in Green, Pennsylvania, USA.
- 1831** Birth of Jesse Rufus Kennedy⁵¹⁴ on 2 March, in Gurnsey, Ohio, USA.
- 1833** Birth of John Ellery Ankrom⁵³¹ on 2 June, in Green, Pennsylvania, USA.
Birth of Jonn Kennedy⁵²² on 19 June, in Vinton, Ohio, USA.
- 1834** Marriage of Edward Kelley⁴⁷² and America Mull⁴⁷³ on 16 February.
Birth of Mary Vicker Kennaday³⁴³ on 18 March.
Birth of Mary B Van Orsdel⁵⁵⁵ on 21 June, in Knox, Indiana, USA.
- 1835** Birth of Mary Ann Ankrom⁵³² on 14 July.
- 1836** Birth of Emiline Kennedy⁵²⁴ on 9 January, in Noble, Ohio, USA.
Birth of Anne Elizabeth Van Orsdel³⁴¹ on 1 August, in Knox, Indiana, USA.
- 1837** Birth of Samuel Kennedy⁵²⁵ on 28 February, in Zaleski, Vinton, Ohio, USA.
Birth of Martha Ann Ankrom⁵³³ on 4 November, in Green, Pennsylvania, USA.
- 1839** Birth of Rebecca Ellen Van Orsdel⁵⁵⁷ on 24 February, in Lexington, Fayette, Kentucky, USA.
- 1840** Birth of William Ankrom⁵³⁴ on 7 April, in Green, Pennsylvania, USA.
Birth of Sarah Jane Kennedy⁵²⁶ on 16 June, in Zaleski, Vinton, Ohio, USA.

- 1841**
Birth of Melinda Catherine Van Orsdel⁵⁵⁹ on 14 October, in Lexington, Fayette, Kentucky, USA.
- 1842**
Birth of Uriah Ankrom⁵³⁵ on 29 May, in Green, Pennsylvania, USA.
Birth of Elizabeth Kennedy⁵²⁷ on 16 June.
Marriage of Benjamin Kirk Shepherd⁵¹⁷ and Nancy Kennedy⁵¹⁶ on 29 December.
- 1843**
Birth of Sarah E Van Orsdel⁵⁶¹ on 31 August, in Cynthiana, Scott, Kentucky, USA.
- 1844**
Birth of Elizabeth Ankrom⁵³⁶ on 27 June, in Green, Pennsylvania, USA.
- 1845**
Birth of Rebecca Kennedy⁵²⁸ on 9 April, in Vinton, Ohio, USA.
Birth of Abram Van Orsdel⁵⁶⁴ on 31 December, in Bourbon, Kentucky, USA.
- 1846**
Death of Abram Van Orsdel⁵⁶⁴ on 4 January.
Birth of Isabell Van Orsdel⁵⁶⁵ on 1 December, in Cynthiana, Scott, Kentucky, USA.
Birth of Miriah Ankrom⁵³⁷ on 28 December, in Green, Pennsylvania, USA.
- 1848**
Birth of Clementine Ankrom⁵³⁸ on 21 November, in Green, Pennsylvania, USA.
- 1849**
Birth of Henery George Van Orsdel⁵⁶⁷ on 17 June, in Owen, Kentucky, USA.
Death of Abram F Van Orsdel, Jr.⁵⁷⁰.
- 1850**
Death of Solomon Ankrom⁵³⁰ on 2 June.
Death of John Ellery Ankrom⁵³¹ on 14 June.
- 1851**
Marriage of William George Van Orsdel⁵⁵¹ and Sarah Catterson⁵⁵² on 22 February.
Birth of James M Minton⁴⁶⁶ on 3 April.
Marriage of Jesse Rufus Kennedy⁵¹⁴ and Sarah Ann Ankrom⁵¹⁵ on 11 December, in Ohio.
- 1852**
Birth of Emaline Kennedy⁴⁹⁷ on 25 October.
- 1853**
Birth of Thomas Ankrom⁵³⁹ on 1 May, in Green, Pennsylvania, USA.
- 1854**
Birth of Mariah Kennedy⁴⁹⁸ on 13 March.
Marriage of James H Van Orsdel⁵⁵³ and Sallie Matoxx⁵⁵⁴ on 22 July.
- 1855**
Death of James Kennaday³⁴⁸ on 5 May.
Death of Martha Ann Ankrom⁵³³ on 24 June.
Marriage of John Hudson Kennaday³⁴⁰ and Anne Elizabeth Van Orsdel³⁴¹ on 30 August, in Boone, Kentucky, USA.
Birth of Nanch Isabell Kennedy⁵⁰⁰ on 25 December.
- 1856**
Marriage of Erasmus E Kelley⁴⁷⁰ and Mary Mc Iwoan⁴⁷¹ on 17 March.
Birth of Margaret Johnson⁴⁶⁷ on 8 May.
Birth of Charles Alonzo Kennaday³²⁹ on 8 November, in Clay, Kentucky, USA.
- 1857**
Birth of John Ronnie Kennedy⁵⁰¹ on 26 December, in Vinton, Ohio, USA.
- 1858**
Birth of Thomas Earl Pearce⁴⁷⁹ on 6 June, in London, England.
Birth of James Edward Kennaday³³¹ on 15 July, in Lexington, Mclean, Illinois, USA.
- 1860**
Marriage of William B Hewitt⁵⁵⁸ and Rebecca Ellen Van Orsdel⁵⁵⁷ on 13 February.
Death of Emaline Kennedy⁴⁹⁷ on 27 February.
Death of Uriah Ankrom⁵³⁵ on 3 March.
Death of Nanch Isabell Kennedy⁵⁰⁰ in March.
Birth of Andrew Kennedy⁵⁰³ on 20 August, in Vinton, Ohio, USA.
- 1861**
Birth of Ida Jane Kennaday³³² on 4 April, in Lexington, Mclean, Illinois, USA.
Marriage of Jonn Kennedy⁵²² and Lydia Jarvis⁵²³ on 6 October, in Nobel.
Marriage of John Benjamin Pollard⁵⁶⁰ and Melinda Catherine Van Orsdel⁵⁵⁹ on 31 December.

- 1862**
Birth of Samuel Rufus Kennedy⁵⁰⁵ on 24 October.
- 1863**
Birth of Lewis Lute Kelley⁴⁶⁴ on 5 February, in Nichlos, County, Kentucky.
Death of William George Van Orsdel⁵⁵¹ on 19 February.
Birth of Mary Elizabeth Skelton⁵¹¹ on 14 August, in Seligman, Barry, Missouri, USA.
- 1864**
Birth of Frances Elizabeth Kennedy³³⁰ on 19 September, in Zaleski, Venton, Ohio, USA.
Birth of Nancy Alice Martindale⁵⁰² on 2 November.
- 1865**
Birth of Amelia Frances Bowles⁴⁶⁵ on 20 June.
Death of John Kennedy⁵⁴⁰ on 10 August, in JacksoTownsh, Ohio, USA.
- 1866**
Death of Clementine Ankrom⁵³⁸ on 8 April.
Birth of James Franklin Kennedy⁵⁰⁷ on 15 November, in Boody, Macon, Illinois.
Marriage of James H Wallace⁵⁶⁶ and Isabell Van Orsdel⁵⁶⁵ on 25 December.
Marriage of Henery George Van Orsdel⁵⁶⁷ and Annie E Mitchell⁵⁶⁸.
- 1868**
Birth of Mary V Kennaday³³³ on 12 January, in Cherokee Nation, USA.
Marriage of Thomas Rogers⁵⁶² and Sarah E Van Orsdel⁵⁶¹ on 3 July.
Birth of William Edson Kennedy⁵⁰⁹ on 15 October, in Boody, Macon, Illinois.
- 1869**
Death of Mary V Kennaday³³³ on 4 October.
- 1870**
Marriage of William S Kelley⁴⁶⁸ and Elizabeth Smith⁴⁶⁹ on 21 May.
Birth of George Washington Kennedy⁵¹⁰ on 11 October, in Ceder Vale, Chautauqua, Kansas, USA.
Birth of John W Kennaday³³⁴ on 5 November, in Springfield, Green, Missouri, USA.
- 1872**
Birth of Mary Adele Lambs- Cobb⁴⁸¹ on 24 September, in Macon, Missouri.
Birth of Sarah Jane Kennedy⁵¹² on 11 December, in Ceder Vale, Chautauqua, Kansas, USA.
- 1875**
Death of James Leighton Kennedy⁵²⁰ on 19 March.
Death of Elizabeth Rhineheart⁵²¹ on 19 March.
Birth of Anne E D Kennaday³³⁵ on 29 April, in Lexington, Mclean, Illinois, USA.
Birth of Emma H Kennaday³³⁶ on 10 September, in Windfield, Cowley, Kansas, USA.
Birth of Anna Marshel³³⁸.
- 1876**
Birth of Della Minton⁴⁵² on 26 February.
Birth of Mary Elizabeth Minton⁴⁴³ on 26 August, in Old Virginia, Virginia.
- 1877**
Marriage of Alferd Shidler⁴⁹⁹ and Mariah Kennedy⁴⁹⁸ on 20 August.
Marriage of Henery George Van Orsdel⁵⁶⁷ and Mattie Anderson⁵⁶⁹.
- 1878**
Birth of Andrew Jackson Kennaday³³⁷ on 15 July, in Ceder Vale, Chautauqua, Kansas, USA.
- 1880**
Death of Sarah Jane Kennedy⁵¹² on 20 March.
Birth of Isabell May Minton⁴⁵³ on 15 May.
- 1882**
Death of Rebecca Kennedy⁵²⁸ on 1 January.
Marriage of Andrew Kennedy⁵⁰³ and Effie Bacus⁵⁰⁴ on 9 May.
Birth of Ida Catherine Minton⁴⁵⁴ on 9 May.
Marriage of John Ronnie Kennedy⁵⁰¹ and Nancy Alice Martindale⁵⁰² on 6 September.
- 1883**
Death of Ida Jane Kennaday³³² on 5 April.
Birth of Millard Gulett³⁷⁷ on 11 August, in Bretthett, Kentucky.
Marriage of Charles Alonzo Kennaday³²⁹ and Frances Elizabeth Kennedy³³⁰ on 11 November, in Cedarvale, Chauauqua, Kansas, USA at Church of Crist.
- 1884**
Birth of James Minton⁴⁵⁵ on 7 August.
Marriage of Lewis Lute Kelley⁴⁶⁴ and Amelia Frances Bowles⁴⁶⁵ on 14 October.
Death of Sarah Elizabeth Kennaday³⁰⁷ on 1 November.
Birth of Sarah Elizabeth Kennaday³⁰⁷ on 1 November, in Ceder Vale, Chautauqua, Kansas, USA.

1885

Birth of Jesse Rufus Kennedy⁴⁸⁸ on 17 May, in Ceder Vale, Chautauqua, Kansas, USA.

1886

Birth of Rosa Marie Kennaday³⁰⁸ on 22 January, in Ceder Vale, Chautauqua, Kansas, USA.

Birth of Maggie Minton⁴⁵⁶ on 13 April.

Marriage of Samuel Rufus Kennedy⁵⁰⁵ and Lillie Tredway⁵⁰⁶ on 8 July.

Birth of Talmadge Blane Kelley⁴⁴² on 12 July, in Vandervill, Kentucky.

1887

Birth of William Allen Fitzpatrick³⁷⁵ on 3 February.

Death of John Ankrom⁵⁴² on 12 May.

1888

Birth of Fredrick Fay Kennedy⁴⁹⁰ on 21 January, in Ceder Vale, Chautauqua, Kansas, USA.

Birth of Anna Ruth Kennaday³¹⁰ on 30 January, in Ceder Vale, Chautauqua, Kansas, USA.

Death of Sarah Jane Raynor⁵⁴¹ on 8 April.

Birth of Carrie Minton⁴⁵⁷ on 7 June.

Marriage of Noah Diehl⁵⁶³ and Sarah E Van Orsdel⁵⁶¹ on 13 June.

Birth of Cora Elizabeth Hutchchison³⁷⁸ on 29 September.

Marriage of James Phipps⁴⁸⁰ and Mary Adele Lambs- Cobb⁴⁸¹.

1889

Death of William Edson Kennedy⁵⁰⁹ on 12 March.

Death of Alonso Kennaday³¹² on 4 April.

Birth of Alonso Kennaday³¹² on 4 April, in Ceder Vale, Chautauqua, Kansas, USA.

Marriage of George Washington Kennedy⁵¹⁰ and Mary Elizabeth Skelton⁵¹¹ on 7 April, in Missouri, USA.

1890

Birth of Sadie Bell Kennedy⁴⁹¹ on 2 January, in Ceder Vale, Chautauqua, Kansas, USA.

Death of Isabell Van Orsdel⁵⁶⁵ on 24 March.

Birth of Henry George Kennaday³¹³ on 11 May, in Ceder Vale, Chautauqua, Kansas, USA.

Birth of Rosayella Minton⁴⁵⁹ on 7 October.

1892

Birth of Phillys Minton⁴⁶⁰ on 8 October.

Birth of Harry Otis Kennaday³¹⁴ on 8 October, in Saratoga, Carbon, Wyoming, USA.

1893

Birth of Frank Forest Kennaday³¹⁶ on 6 November, in Saratoga, Carbon, Wyoming, USA.

Birth of Alice Pearce⁴⁷⁷ on 28 December, in Denver, Colorado.

1894

Birth of Walter Minton⁴⁶² on 12 August.

Birth of Fairfax Harry Davidson³²¹.

Birth of Logan Turner Cairns³²⁵ in Rawlins, Carbon, Wyoming, USA.

1895

Death of Sarah E Van Orsdel⁵⁶¹ on 27 February.

Birth of Edward Thomas Kennaday³¹⁸ on 9 October, in Saratoga, Carbon, Wyoming, USA.

1896

Death of Samuel Rufus Kennedy⁵⁰⁵ on 29 January.

Birth of Ethel Minton⁴⁶³ on 1 June.

1897

Birth of Mable Pierce³¹⁷ on 5 January, in Denver, Colorado.

Birth of Alice Oda May Kennaday³²⁰ on 13 April, in Saratoga, Carbon, Wyoming, USA.

1898

Birth of Charles Fredrick Kennaday³²² on 30 November, in Saratoga, Carbon, Wyoming, USA.

1899

Marriage of James Franklin Kennedy⁵⁰⁷ and Louise Whited⁵⁰⁸ on 11 March.

Death of Joseph Bryson Kennaday³³⁹ on 20 May.

Death of Jesse Rufus Kennedy⁵¹⁴ on 7 August, in Ceder Vale, Chautauqua, Kansas, USA.

1900

Death of Rebecca K Boice⁵⁷¹ on 6 April, in Clay, City Powel, Kentucky, USA.

Birth of Alice Mannahan³¹⁹ in Saratoga, Carbon, Wyoming, USA.

1901

Death of Henry George Kennaday³¹³ on 20 May.

Death of Nancy Kennedy⁵¹⁶.

1903

Birth of Loyd Andrew Kennaday³²⁶ on 2 August, in Saratoga, Carbon, Wyoming, USA.

1904

Marriage of Fred Peters³⁰⁹ and Rosa Marie Kennaday³⁰⁸ on 7 March, in Saratoga, Wyoming.

1905

Marriage of Ed Stewart³¹¹ and Anna Ruth Kennaday³¹⁰ on 30 September.

Birth of Emma Helen Kennaday³²⁴ on 8 December, in Saratoga, Carbon, Wyoming, USA.

1906

Birth of Lillie Irene Kennedy⁴⁹³ on 4 May, in Ceder Vale, Chautauqua, Kansas, USA.

Birth of Mable Vilote Stewart²⁴⁶.

1907

Death of Mary Vicker Kennaday³⁴³ on 18 February.

Birth of Fay Kennaday³²⁸ on 14 June, in Saratoga, Carbon, Wyoming, USA.

Death of Rosa Marie Kennaday³⁰⁸ on 22 July, in Saratoga, Wyoming.

1908

Marriage of Jay McClure⁴⁹² and Sadie Bell Kennedy⁴⁹¹ on 29 January.

Death of Fredrick Fay Kennedy⁴⁹⁰ on 29 November.

1909

Marriage of Talmadge Blane Kelley⁴⁴² and Mary Elizabeth Minton⁴⁴³ on 16 December.

Birth of Frances Luella Stewart²⁴⁷.

1910

Marriage of Jesse Rufus Kennedy⁴⁸⁸ and Fay McClure⁴⁸⁹ on 6 April.

1911

Birth of James Luther Kelley⁴³² on 31 March.

Death of Mariah Kennedy⁴⁹⁸ on 14 November.

Birth of Earl N Ramsey²⁵⁶.

1912

Death of John Hudson Kennaday³⁴⁰ on 8 November.

Birth of George Martin Stewart²⁴⁸.

1913

Marriage of Frank Forest Kennaday³¹⁶ and Mable Pierce³¹⁷ on 4 July.

Birth of Walter Cecil Ackerson²⁸⁶.

1914

Death of Mary B Van Orsdel⁵⁵⁵ on 11 March.

Birth of Thomas Earl Kennaday²⁵² on 7 July, in Saratoga, Carbon, Wyoming, USA.

Birth of Gladys Eleanor Ream²⁵³ in Superior, Colorado, USA.

1915

Birth of Inez Henderson³²⁷ on 3 February.

Birth of Harvey Alton Blackburn²⁸².

1916

Death of Anne Elizabeth Van Orsdel³⁴¹ on 10 February, in Carbon, Wyoming, USA.

Marriage of Fairfax Harry Davidson³²¹ and Alice Oda May Kennaday³²⁰ on 11 May.

Birth of Edward S (Pete) Fitzpatrick³⁷² on 8 July, in Bourbon, Kentucky, USA.

1917

Birth of Talmadge Blane Kelley, Jr.⁴³⁴ on 28 January.

Birth of Florence Mae Kennaday²⁵⁴ on 28 June, in Saratoga, Carbon, Wyoming, USA.

Death of James M Minton⁴⁶⁶ on 23 October.

Birth of John David Kelley²⁶² on 28 December.

Birth of Frances Amonda Davidson²⁷⁵ in Denver, Adams, Colorado, USA.

1918

Death of James Franklin Kennedy⁵⁰⁷ on 21 January.

Marriage of Edward Thomas Kennaday³¹⁸ and Alice Mannahan³¹⁹ on 11 August.

Birth of Vita Maude Davidson²⁷⁷ in Saratoga, Carbon, Wyoming, USA.

Birth of Robert Orrin Rogerson²⁷⁸.

1919

Birth of Cristine Sapp⁴³³ on 15 February.

Birth of Forest Jack Kennaday²⁵⁷ on 22 November, in Saratoga, Carbon, Wyoming, USA.

Birth of Ellen (Dude) Stockwell²⁵⁸ in Saratoga, Carbon, Wyoming, USA.

- 1920**
 Birth of James Martin Marier²⁶⁵ on 22 February, in El Vado, Rio Arriba, New Mexico, USA.
 Death of Sarah Ann Ankrom⁵¹⁵ on 29 March, in Ceder Vale, Chautauqua, Kansas, USA.
 Birth of Louize Gertrude Davidson²⁸¹ in Saratoga, Carbon, Wyoming, USA.
 Death of William C Kennaday²⁶⁸.
 Birth of William C Kennaday²⁶⁸ in Saratoga, Carbon, Wyoming, USA.
 Birth of Bruce Douglas Whitman²⁷⁶.
- 1921**
 Death of Rebecca Ellen Van Orsdel⁵⁵⁷ on 18 January.
 Birth of Rose Marie Kennaday²⁵⁹ on 10 October, in Saratoga, Carbon, Wyoming, USA.
 Birth of Olive Ruth Stewart²⁴⁹ in Blue Lake, Humboldt, Calaforina, USA.
 Birth of Chester Clark Davidson²⁸³.
- 1922**
 Death of Sadie Bell Kennedy⁴⁹¹ on 5 December.
- 1923**
 Birth of Virginia Ruth Gulett³⁷⁴ on 23 February, in Richmond, Kentucky, USA.
 Death of Emiline Kennedy⁵²⁴ on 19 May.
 Birth of Iva June Kennaday²⁶¹ on 13 June, in Saratoga, Carbon, Wyoming, USA.
 Death of Andrew Jackson Kennaday³³⁷ on 8 December, in Saratoga, Carbon, Wyoming, USA.
 Birth of Eleanora Alice Davidson²⁸⁵.
- 1925**
 Birth of Bonnie Jean Kennaday²⁶³ on 6 April.
 Marriage of Logan Turner Cairns³²⁵ and Emma Helen Kennaday³²⁴ on 3 December, in Denver, Denver, Colorado, USA.
- 1926**
 Death of John Ronnie Kennedy⁵⁰¹ on 20 January.
- 1927**
 Birth of John E Kennaday²⁶⁹ in Saratoga, Carbon, Wyoming, USA.
 Death of John E Kennaday²⁶⁹.
 Birth of Charles Daniel Davidson²⁸⁷.
- 1928**
 Birth of Lincoln Frank Kennaday²⁶⁶ on 9 April, in Saratoga, Carbon, Wyoming, USA.
 Birth of Beverly Ann Johnson²⁹⁵ in Hanna, Carbon, Wyoming, USA.
- 1929**
 Birth of Joan Olivia Debernardi²⁶⁷ on 30 April, in Roseburg, Douglas, Oregon, USA.
 Death of Andrew Kennedy⁵⁰³ on 12 September.
 Birth of Earlene Dee Noller²⁸⁸.
 Birth of Myrtle Rae Davidson²⁸⁹.
 Birth of Charles Leroy Stewart²⁵⁰ in Blue Lake, Humboldt, Calaforina, USA.
- 1930**
 Birth of Jack Lavoy Cairns²⁹⁴ in Rawlins, Carbon, Wyoming, USA.
- 1931**
 Death of Talmadge Blane Kelley⁴⁴² on 6 February.
 Death of George Washington Kennedy⁵¹⁰ on 30 March.
 Birth of Mary Lou Kennaday²⁷⁰ in Saratoga, Carbon, Wyoming, USA.
 Birth of Catherine Marie Kennaday²⁷¹ in Saratoga, Carbon, Wyoming, USA.
- 1932**
 Marriage of James Luther Kelley⁴³² and Cristine Sapp⁴³³ on 10 June.
 Death of Lewis Lute Kelley⁴⁶⁴ on 25 July, in Ad Richeys home in Myers station.
 Birth of Dorthy Mae Kelley⁴⁰⁷ on 3 December, in Carlisle, Kentucky, USA.
 Birth of Fred E Kennaday²⁷² in Saratoga, Carbon, Wyoming, USA.
- 1933**
 Marriage of Thomas Earl Kennaday²⁵² and Gladys Eleanor Ream²⁵³ on 13 May, in Rawlins, Carbon, Wyoming, USA.
 Marriage of Charles Fredrick Kennaday³²² and Margaret Bays³²³ on 18 July.
 Birth of Cornell Alexander Sobo, Jr.¹²⁷ on 28 October.
 Birth of Charlotte Arlene Kennaday¹²⁶ on 28 October.
 Birth of Margaret Faunita Cairns²⁹⁶ in Rawlins, Carbon, Wyoming, USA.
 Death of Fred E Kennaday²⁷².
- 1934**
 Death of Melinda Catherine Van Orsdel⁵⁵⁹ on 6 June.
 Death of James Edward Kennaday³³¹ on 6 June.

1935

Birth of Eugene Kelley⁴⁰⁹ on 25 April, in Carlisle, Kentucky, USA.
 Birth of Thomas Eugene Kennaday¹²⁸ on 14 August, in Saratoga, Carbon, Wyoming, USA.
 Marriage of Earl N Ramsey²⁵⁶ and Florence Mae Kennaday²⁵⁴ on 21 October.
 Birth of Ronald Clark Redman²⁹¹.

1936

Death of Catherine Marie Kennaday²⁷¹.

1937

Birth of Juanita Kelley⁴¹¹ on 15 March, in Carlisle, Kentucky, USA.
 Birth of Earl Efton (Butch) Ramsey¹³² on 24 April.
 Birth of Patty Ray Kennaday¹³⁰ on 3 August, in Rawlins, Carbon, Wyoming, USA.
 Birth of Rosa L Hubbard¹³³ on 26 September.
 Marriage of Loyd Andrew Kennaday³²⁶ and Inez Henderson³²⁷ on 23 October, in Saratoga, Carbon, Wyoming, USA.
 Birth of August Henry Geppert¹³¹ in Portland, Washington, Oregon, USA.

1938

Death of Margaret Johnson⁴⁶⁷ on 7 March.
 Death of Frances Elizabeth Kennedy³³⁰ on 10 June, in Saratoga, Carbon, Wyoming, USA.
 Birth of Jack J Kennaday³⁰¹ on 18 September, in Saratoga, Carbon, Wyoming, USA.
 Birth of Alice Ann Kennaday²⁷⁴ in Saratoga, Carbon, Wyoming, USA.

1939

Birth of Mary Elizabeth Kelley⁴¹⁴ on 2 January, in Carlisle, Kentucky, USA.
 Birth of Jack Wayne Kennaday¹³⁶ on 15 December.
 Birth of Nelson Chester Whitman¹⁷⁴ in BigPiney, Sublette, Wyoming, USA.

1940

Birth of Jimmy Ray Lott¹⁴³ on 22 March.
 Death of Harry Otis Kennaday³¹⁴ on 25 April, in Cheyenne, Laramie, Wyoming, USA.
 Death of Mable Pierce³¹⁷ on 27 May, in Saratoga, Carbon, Wyoming, USA.
 Death of Charles Alonzo Kennaday³²⁹ on 6 December, in Saratoga, Carbon, Wyoming, USA.
 Birth of Carl L Kennaday³⁰² on 18 December, in Saratoga, Carbon, Wyoming, USA.
 Birth of Boyd David Whitman¹⁷⁸ in BigPiney, Sublette, Wyoming, USA.
 Birth of Norman Perry Curtis¹⁵⁷.

1941

Birth of Richard Ward Whitman¹⁸⁰ in BigPiney, Sublette, Wyoming, USA.
 Birth of Dorothy Lorraine Cairns²⁹⁸ in Rawlins, Carbon, Wyoming, USA.

1942

Birth of Gary Forrest Kennaday¹³⁸ on 7 February.
 Birth of Wanda Lou Kelley⁴¹⁶ on 22 February, in Carlisle, Kentucky, USA.
 Birth of Joy L Kennaday³⁰⁴ on 17 April, in Saratoga, Carbon, Wyoming, USA.
 Birth of Sherry Jean Marier¹⁶⁰ on 22 November.
 Birth of Robert Harry Rogerson¹⁹².
 Death of Dorothy Lorraine Cairns²⁹⁸.

1943

Birth of Ronald David Kelley, Sr.¹⁵⁴ on 10 September, in Pueblo, Colorado, USA.
 Birth of Garrett David Ackerson²⁰².

1944

Birth of Donald Fay Kennaday³⁰⁶ on 18 May, in Saratoga, Carbon, Wyoming, USA.
 Birth of Charlotte Louise Whitman¹⁸² in BigPiney, Sublette, Wyoming, USA.

1945

Birth of Jane Marie Marier¹⁶³ on 4 February.
 Birth of Carolyn June Kelley¹⁵⁶ on 8 February, in Carlisle, Kentucky, USA.
 Marriage of Ellen (Dude) Stockwell²⁵⁸ and Forest Jack Kennaday²⁵⁷ on 9 June.
 Marriage of Lincoln Frank Kennaday²⁶⁶ and Joan Olivia Debernardi²⁶⁷ on 25 October.
 Birth of Cristine Faye Kelley⁴¹⁸ on 9 December, in Carlisle, Kentucky, USA.
 Birth of Edward J McCrea¹⁹⁷.
 Birth of Terry Walter Ackerson²⁰⁴.
 Birth of Craig Martin Schmeling³⁰⁰ in Whittemore, Platte, Wyoming, USA.

1946

Birth of Gary Jo Kennaday¹⁶⁵ on 4 March, in Roseburg, Douglas, Oregon, USA.
 Birth of Marcella Ann Whitman¹⁸⁴.
 Birth of Kay Harding²⁰⁵.
 Birth of Patricia Cox²⁰⁶.
 Birth of Katheryne Louise Blackburn¹⁹⁶.

1946 (continued)

Death of Mary Miranda Unknown⁵⁹⁷.
 Birth of Judy Ann Cairns²⁹⁹ in Rawlins, Carbon, Wyoming, USA.

1947

Birth of Betty Carol Fitzpatrick¹⁵⁵ on 14 April, in Paris, Bourbon, Kentucky, USA.
 Birth of Wesley Cecil Ackerson²⁰⁷.

1948

Marriage of James Martin Marier²⁶⁵ and Bonnie Jean Kennaday²⁶³ on 6 April.
 Marriage of John David Kelley²⁶² and Iva June Kennaday²⁶¹ on 8 August, in Flemmingburg, Kentucky, USA.
 Birth of Evelyn Anderson²⁰³.
 Birth of Phillis Lana Whitman¹⁸⁶.
 Birth of Wilma Elaine Rogerson¹⁹³.
 Birth of Danny Ray Ackerson²⁰⁹.

1949

Birth of David Debernardi Kennaday¹⁶⁷ on 8 January, in Roseburg, Douglas, Oregon, USA.
 Birth of Ruth Orrine Rogerson¹⁹⁴.
 Birth of Daniel Clark Davidson²⁰⁰.

1950

Birth of Linda Ann Cairns²²⁶.
 Birth of Ronald Otis Page²²⁷ in Colorado Springs, ElPaso, Colorado, USA.
 Birth of Nancy Sue Kurth²¹⁰.

1951

Birth of Gary Scott³⁸³ on 3 January.
 Birth of Brenda Jane Kelley⁴²¹ on 25 August, in Carlisle, Kentucky, USA.
 Death of Edward Thomas Kennaday³¹⁸ on 16 October.
 Birth of Suellen Louise Davidson²¹¹.
 Birth of Christine Marie Cairns²²⁸ in Rawlins, Carbon, Wyoming, USA.

1952

Death of Nancy Alice Martindale⁵⁰² on 27 August, in Polk, Missouri, USA.
 Birth of Laurel Alice Whitman¹⁸⁸.

1953

Birth of James Luther Kelley, Jr.⁴²² on 14 February, in Carlisle, Kentucky, USA.
 Birth of John Ellery Masters²¹².
 Birth of Jack Lavoy Cairns, Jr.²³⁰ in Rock Springs, Sweetwater, Wyoming, USA.
 Birth of Richard Norman Wilson²³⁸ in Rawlins, Carbon, Wyoming, USA.
 Birth of Harvey David Blackburn¹⁹⁸.
 Birth of Paula Jo Smith¹⁶⁸ in Roseburg, Douglas, Oregon, USA.
 Death of Robert Harry Rogerson¹⁹².

1954

Birth of Bobby Gene Kelley³⁸⁵ on 8 August, in Carlisle, Kentucky, USA.
 Birth of Freddie Warren Kelley⁴²³ on 24 September, in Carlisle, Kentucky, USA.
 Birth of Kenneth Logan Wilson²³⁹ in Rawlins, Carbon, Wyoming, USA.
 Birth of John Ellery Cooper²³⁷ in Yonkers, New York, USA.
 Birth of Elizabeth Kay Cairns²³² in Rawlins, Carbon, Wyoming, USA.
 Birth of Jean Marie Davidson²⁰¹.

1955

Death of Frank Forest Kennaday³¹⁶ on 11 November.
 Birth of Donnie Lee Kelley⁴²⁴ on 25 November, in Carlisle, Kentucky, USA.
 Birth of Phyllis Ann Wilson²⁴⁰ in Rawlins, Carbon, Wyoming, USA.
 Birth of William Wayne Cairns²³⁴ in Rawlins, Carbon, Wyoming, USA.
 Birth of Craig Campbell²²⁹.
 Birth of Rebecca Cassler²³¹.
 Birth of Kristy Lee Ary²⁰⁸.

1956

Birth of Steven Scott Kennaday¹⁶⁹ on 5 March, in Roseburg, Douglas, Oregon, USA.
 Death of James Luther Kelley⁴³² on 27 March, in Carlisle, Kentucky, USA.
 Death of Freddie Warren Kelley⁴²³ on 4 November, in Carlisle, Kentucky, USA.
 Death of Alice Mannahan³¹⁹.
 Birth of Catherine Susan Lavelle¹⁷⁰ in Van Nuys, California, USA.
 Birth of James Vencent Boyd²¹ in Cleveland, Ohio, USA.
 Birth of Brigid Ann Young¹⁷³ in Burbank, Los Angeles, California, USA.
 Birth of Rebecca Gay Cairns²³⁶ in Rawlins, Carbon, Wyoming, USA.

1957

Birth of Fredrick Frank Kennaday¹⁷² on 5 May, in Roseburg, Douglas, Oregon, USA.
 Birth of Charles Whitman¹⁹¹.
 Birth of Linda Hayes⁶⁶.
 Birth of Kae Porter²³⁵ in Ceder City, Iron, Utah, USA.

1958

Birth of Brenda Sue Sobo²⁰ on 22 March, in Klamath, Falls, Klamath, Organ, USA.
 Birth of Billy Dean Kelley⁴²⁵ on 9 June, in Carlisle, Kentucky, USA.
 Marriage of August Henry Geppert¹³¹ and Patty Ray Kennaday¹³⁰ on 26 July.
 Birth of Delera Kay Lott³⁸ on 8 November.
 Death of John Harvey Sapp⁵⁹⁶ on 18 December.
 Death of John W Kennaday³³⁴ on 19 December.
 Birth of Toby Hayes⁷⁰.

1959

Birth of Randy Eugene Sobo²² on 7 July, in Medford, Jackson, Organ, USA.
 Birth of Donna Scott³⁸⁴ on 4 August.
 Birth of Rosa e Mary Berryman³⁹⁵ on 26 September.
 Death of Anna Ruth Kennaday³¹⁰ on 6 November, in Ceder Vale, Chautauqua, Kansas, USA.
 Birth of Robbyn Cherter Whitman⁸⁷.

1960

Birth of Lori Ann Geppert²⁸ on 18 February, in Portland, Washington, Organd, USA.
 Death of Millard Gulett³⁷⁷ on 8 March, in Harrisburg, Mercer, Kentucky, USA.
 Birth of Todd Kennaday³³ on 5 May, in Oregon.
 Birth of Lee Ann Marie Lott⁴² in August.
 Birth of Teresa Lynn Sobo²⁴ on 19 August, in Medford, Jackson, Organ, USA.
 Birth of John Frank Lott⁴⁶ on 23 September.
 Death of Anne E D Kennaday³³⁵ on 4 October.
 Death of Anna Marshal³³⁸ on 8 December, in Saratoga, Carbon, Wyoming, USA.
 Birth of Kathy Ann Lott³⁹ on 12 December.
 Birth of Peri Ann Whitman⁸⁸.
 Marriage of Thomas Eugene Kennaday¹²⁸ and Janice Benson¹²⁹ in Antonio, Texas.
 Birth of Charles Noller Davidson²¹⁶.
 Birth of Gerald Noller Tomayer²¹⁵.

1961

Death of Mary Elizabeth Minton⁴⁴³ on 26 January, in Carlisle, Kentucky, USA.
 Death of Betty Jack Osburn³⁷⁶ in April, in Northmiddle Town, Kentucky, USA.
 Birth of Gilbert Berryman³⁹⁶ on 20 April.
 Birth of Karla Lynn Kennaday²⁶ on 8 July, in Vallejo, Napa, Califorina, USA.
 Death of Charles Fredrick Kennaday³²² on 6 December.
 Marriage of John Jennings³⁰⁵ and Joy L Kennaday³⁰⁴.

1962

Birth of Julie Mae Berryman³⁹⁷ on 2 June.
 Birth of Calvin E Terett Lott⁴³ in July.
 Birth of Gordon Scott (Scotty) Johnson⁸² on 10 August.
 Birth of Randy Eugene Lott¹⁵³ on 29 December.
 Birth of Kathy Kay Kennaday²⁷ in Vallejo, Napa, Califorina, USA.
 Birth of Judy Arlene Geppert³⁰ in Portland, Washington, Organd, USA.
 Birth of Karen Hayes⁷¹.
 Birth of Joyce Ellen Jorgensen³⁴ in Phoenix, Orange, Arizona, USA.
 Birth of Richard Lee Wells²¹⁹.
 Birth of Marcus Pine Whitman⁴⁷⁴.
 Birth of Marcus Pine Whitman⁸⁹.
 Birth of Lorraine Madden¹⁷⁷.

1963

Marriage of Norman Perry Curtis¹⁵⁷ and Carolyn June Kelley¹⁵⁶ on 12 January, in Carlisle, Kentucky, USA.
 Marriage of Ronald David Kelley, Sr.¹⁵⁴ and Betty Carol Fitzpatrick¹⁵⁵ on 6 April, in Carlisle, Kentucky, USA.
 Death of Julie Mae Berryman³⁹⁷ on 3 September.
 Birth of Diana Lott⁴⁷ on 13 September.
 Birth of Freda Jean Berryman³⁹⁸ on 14 September.
 Marriage of Charles Raymond Thompson³⁷¹ and Sandra Darlene Fitzpatrick³⁷⁰ in November.
 Birth of Lisa June Kelley⁵² on 18 December, in Carlisle, Kentucky, USA.
 Birth of Celeste Marie Hoffman¹⁹⁹.

1963 (continued)

Birth of Keren Lynne Harned²¹⁸.
 Birth of Tori Dawn Bartlett⁹⁵.

1964

Birth of Donna Denice Thompson³⁶¹ on 6 January, in Huntsville, Alabama, USA.
 Death of Donna Denice Thompson³⁶¹ on 18 February, in Huntsville, Alabama, USA.
 Birth of Darren Kennaday³⁵ on 19 February.
 Birth of Anita Carol Curtis⁶² on 9 April, in Carlisle, Nicholas, Kentucky, USA.
 Birth of MAnnett Marie Lott⁴⁰ on 4 June.
 Birth of Tommy Berryman, II³⁹⁹ on 3 September.
 Birth of Anna Carol Kelley⁵⁶ on 27 November.
 Birth of Tommy Duane Geppert³² in Portland, Washington, Oregon, USA.

1965

Death of William Allen Fitzpatrick³⁷⁵ on 12 March, in Northmiddle Town, Kentucky, USA.
 Birth of Stanley (Stan) Johnson⁸³ on 14 June.
 Birth of Katy Sue Blunt⁴⁴ on 21 June.
 Birth of Kelly Michele Kennaday³⁶ on 9 July.
 Marriage of Robert Therman Williams³⁶⁸ and Tempie Ann Fitzpatrick³⁶⁶ on 27 November.
 Death of Wilma Elaine Rogerson¹⁹³.
 Birth of Kathleen Marie Redman²²⁰.

1966

Birth of Mike Allen Forrester, Jr.⁸⁴ on 22 January.
 Birth of Roxy Ann Lott⁴¹ on 24 January.
 Birth of Ronald David Kelley, Jr.⁵⁸ on 9 June, in Lexington, Kentucky, USA.
 Birth of Norman Perry Curtis, Jr.⁶⁷ on 28 August, in Indianapolis, Marion, Indiana, USA.
 Birth of Bradly Tommy Thompson⁹⁸.

1967

Marriage of Cecil Ray Montgomery³⁷³ and Virginia Ruth Gulett³⁷⁴ on 3 February.
 Birth of Michele Lott⁴⁸ in June.
 Birth of Jeffrey Michael Kennaday³⁷ on 26 September.
 Birth of Grant Douglas Whitman⁹³.
 Birth of Fred Winton Smith⁹⁹.
 Death of Fairfax Harry Davidson³²¹.

1968

Birth of Tommy James Forrester⁸⁵ on 4 May.
 Death of Logan Turner Cairns³²⁵.
 Birth of Gail Robin Whitman⁹⁴.
 Birth of Micheal Gerald Sturm Whitman⁹⁰.

1969

Birth of Collin Wade Whitman¹⁰⁰.
 Birth of Travis Darryl Bartlett⁹⁶.
 Birth of Patrick Keith Whitman⁹¹.

1970

Birth of Melony Jo Curtis⁶⁹ on 14 January, in Indianapolis, Marion, Indiana, USA.
 Death of John David Kelley²⁶² on 21 April, in Carlisle, Kentucky, USA.
 Death of Melony Jo Curtis⁶⁹ on 8 December, in Indianapolis, Marion, Indiana, USA.
 Birth of Kathryn Victoria Redman²²⁴.

1971

Birth of Thomas Elliott Page¹⁰⁴ in Ogden, Weber, Utah, USA.

1972

Marriage of Ronald Lee Abner³⁶⁹ and Tempie Ann Fitzpatrick³⁶⁶ on 4 July.
 Death of Mary Lou Kennaday²⁷⁰.

1973

Birth of David Earl Curtis⁷² on 17 April, in Indianapolis, Marion, Indiana, USA.
 Birth of Johnathan Jack Page¹⁰⁵ in Rawlins, Carbon, Wyoming, USA.
 Birth of Nathanielle Rebecca Whitman⁹².

1974

Death of Fay Kennaday³²⁸ on 23 May.
 Birth of Ronnie Wesley Redman²²⁵.
 Birth of Trevor David Bartlett⁹⁷.
 Marriage of Carl L Kennaday³⁰² and Carol Brugus³⁰³.
 Birth of Stuart Branson Self¹⁰¹.

1975

Birth of Donald Grant Page¹⁰⁶ in Rawlins, Carbon, Wyoming, USA.
 Birth of Kreetta Ann Jebens¹²³ in Rawlins, Carbon, Wyoming, USA.
 Birth of Ian Mathew Self¹⁰².
 Birth of Jeremy Alan Hansen¹¹² in Craig, Moffat, Colorado, USA.

1976

Birth of Aaron Wayne Hansen¹¹³ in Idaho Falls, Bonneville, Idaho, USA.
 Birth of Tyler Martin Schmeling²⁴² in Weatland, Platte, Wyoming, USA.

1977

Birth of Ashley Chester Self¹⁰³.
 Birth of Steve Hix¹²¹.
 Birth of Tiffany Anne Cooper¹²⁰ in Logan, Cache, Utah, USA.
 Birth of Korey Kay Jebens¹²⁴ in Rawlins, Carbon, Wyoming, USA.

1978

Death of Edward S (Pete) Fitzpatrick³⁷² on 8 November, in Bourbon, Kentucky, USA.
 Birth of Nicholas Isaiah Kennaday⁷⁴ in Roseburg, Douglas, Oregon, USA.
 Birth of Triana Marie Campbell¹⁰⁷ in Salt Lake City, Salt Lake, Utah, USA.
 Birth of Hillary Ranee Cooper¹²² in Logan, Cache, Utah, USA.
 Birth of Amy Nichole Schmeling²⁴³ in Cheyenne, Laramie, Wyoming, USA.

1979

Death of Alice Oda May Kennaday³²⁰ on 6 December, in Rawlins, Carbon, Wyoming, USA.
 Birth of Rachel Elizabeth Cairns¹¹⁰.
 Birth of Michael Brent Hansen¹¹⁴ in Idaho Falls, Bonneville, Idaho, USA.
 Birth of Patricia Leigh Kennaday⁸⁰ in San Diego, San Diego, California, USA.
 Birth of Carlie Norman Jebens¹²⁵ in Rawlins, Carbon, Wyoming, USA.

1980

Birth of Clarence Bland Kennedy⁴⁹⁵ on 9 April, in Ceder Vale, Chautauqua, Kansas, USA.
 Birth of Elizabeth Alta Olivia Kennaday⁷⁵ in Roseburg, Douglas, Oregon, USA.
 Birth of Holly Ann Campbell¹⁰⁸ in Salt Lake City, Salt Lake, Utah, USA.

1981

Birth of Anthony Joseph Kennaday⁸¹ in Roseburg, Douglas, Oregon, USA.
 Birth of Amy Nicole Hansen¹¹⁵ in Idaho Falls, Bonneville, Idaho, USA.

1982

Marriage of Cristian Hunnicutt⁵³ and Lisa June Kelley⁵² on 13 February, in Indianapolis, Indiana, USA.
 Birth of Justin Kyle Sobo³ in Medford, Jackson, Organ, USA.
 Birth of Cristina Dianne Kennaday⁷⁶ in Roseburg, Douglas, Oregon, USA.
 Birth of Joshua Jolin Kennaday⁷⁷ in Glide, Douglas, Oregon, USA.

1983

Birth of Christian David Hunnicutt⁹ on 10 January, in Indianapolis, Indiana, USA.
 Marriage of Gregory Wert⁵⁷ and Anna Carol Kelley⁵⁶ on 28 May, in Indianapolis, Indiana, USA.
 Death of Loyd Andrew Kennaday³²⁶ on 10 December.
 Birth of Jacob Karl Hansen¹¹⁶ in Idaho Falls, Bonneville, Idaho, USA.
 Birth of Mary Melissa Cairns¹¹¹.
 Birth of Dorci Kae Cairns¹¹⁷ in Idaho Falls, Bonneville, Idaho, USA.

1984

Marriage of Mike Phelps⁶⁵ and Anita Carol Curtis⁶² on 27 August.

1985

Death of Alice Ann Kennaday²⁷⁴.
 Birth of Julie Erin Sobo⁴ in Medford, Jackson, Organ, USA.
 Birth of Eric Raymond Campbell¹⁰⁹ in Salt Lake City, Salt Lake, Utah, USA.

1987

Marriage of Mark Meyer⁶⁰ and Sherrie (Like a Daughter) Jones⁵⁹ in November.
 Birth of Travis Andrew Sobo⁵ in Medford, Jackson, Organ, USA.
 Birth of Tyler Jamison Sobo⁶ in Medford, Jackson, Organ, USA.
 Birth of Adam Malaki Kennaday⁷ in Anaheim, Orange, Calafornia, USA.

1988

Death of Emma Helen Kennaday³²⁴ on 26 August, in Rawlins, Carbon, Wyoming, USA.
 Birth of Jace William Cairns¹¹⁸ in Idaho Falls, Bonneville, Idaho, USA.

1990

Marriage of James Mickel Asbury⁵⁴ and Lisa June Kelley⁵² on 26 May, in Cynthiana, Scott, Kentucky, USA.
Birth of Aaron Forest Kennaday⁸ in Anaheim, Orange, California, USA.
Death of Robert Therman Williams³⁶⁸.
Death of Gladys Eleanor Ream²⁵³.

1991

Birth of James Mathew Asbury¹⁰ on 28 June, in Lexington, Kentucky, USA.
Death of Inez Henderson³²⁷ on 22 September, in Saratoga, Carbon, Wyoming, USA.
Birth of Brindi Michelle Cairns¹¹⁹ in Idaho Falls, Bonneville, Idaho, USA.

1992

Birth of Caitlin Arlena Boyd¹ in Manaqua, Nicaragua.

1993

Death of Carolyn June Kelley¹⁵⁶ on 25 July.

1994

Birth of Mercedes Curtis¹⁷ in August, in Indianapolis, Marion, Indiana, USA.
Birth of Jason Alexander Boyd².

1995

Birth of Savanna June Curtis¹⁸ on 14 June, in Indianapolis, Marion, Indiana, USA.
Death of Carlie Norman Jebens¹²⁵.

1996

Marriage of David Earl Curtis⁷² and Toni Benner⁷³ on 7 July.
Birth of Ivie Ski Curtis¹⁹ on 11 November.
Death of Charles Leroy Stewart²⁵⁰.

1997

Death of Ronald David Kelley, Jr.⁵⁸ on 15 September, in Indianapolis, Marion, Indiana, USA.

1999

Death of James Martin Marier²⁶⁵.

2005

Death of Iva June Kennaday²⁶¹ on 16 March, in Indianapolis, Indiana, USA.

2007

Death of Virginia Ruth Gullett³⁷⁴ on 21 January, in Holiday, Pasco, Florida, USA.

17. INDEX OF INDIVIDUALS

| <u>Ref.</u> | <u>Tree</u> | <u>Name (Relationship)</u> |
|-------------|-------------|---|
| 437 | | WATKINS, Efrfie Mae (John David Kelley's cousin). |
| 448 | | Mr. (John David Kelley's uncle by marriage). |
| 358 | | ABNER, Jamie Christene (Betty Carol Fitzpatrick's niece). |
| 369 | | Ronald Lee (Betty Carol Fitzpatrick's brother-in-law). |
| 357 | | Ronald Lee, Jr. (Betty Carol Fitzpatrick's nephew). |
| 209 | 56 | ACKERSON, Danny Ray (James's great-great-great-grandson). |
| 202 | 56 | Garrett David (James's great-great-great-grandson). |
| 204 | 56 | Terry Walter (James's great-great-great-grandson). |
| 286 | 56 | Walter Cecil (James's great-great-granddaughter's husband). |
| 207 | 56 | Wesley Cecil (James's great-great-great-grandson). |
| 203 | | ANDERSON, Evelyn (James's great-great-great-grandson's wife). |
| 569 | | Mattie (Anne Elizabeth Van Orsdel's sister-in-law). |
| 538 | | ANKROM, Clementine (Frances Elizabeth Kennedy's aunt). |
| 536 | | Elizabeth (Frances Elizabeth Kennedy's aunt). |
| 542 | | John (Frances Elizabeth Kennedy's grandfather). |
| 531 | | John Ellery (Frances Elizabeth Kennedy's uncle). |
| 548 | | Joseph (Frances Elizabeth Kennedy's great-grandfather). |
| 533 | | Martha Ann (Frances Elizabeth Kennedy's aunt). |
| 532 | | Mary Ann (Frances Elizabeth Kennedy's aunt). |
| 537 | | Miriah (Frances Elizabeth Kennedy's aunt). |
| 529 | | Richard (Frances Elizabeth Kennedy's uncle). |
| 515 | | Sarah Ann (Frances Elizabeth Kennedy's mother). |
| 530 | | Solomon (Frances Elizabeth Kennedy's uncle). |
| 539 | | Thomas (Frances Elizabeth Kennedy's uncle). |
| 535 | | Uriah (Frances Elizabeth Kennedy's uncle). |
| 534 | | William (Frances Elizabeth Kennedy's uncle). |
| 546 | | William (Frances Elizabeth Kennedy's great-grandfather). |
| 208 | | ARY, Kristy Lee (James's great-great-great-grandson's wife). |
| 10 | 5 | ASBURY, James Mathew (James's five-times-great-grandson). |
| 54 | 5 | James Mickel (James's four-times-great-granddaughter's husband). |
| 11 | 5 | Liam Joseph (James's five-times-great-grandson). |
| 504 | | BACUS, Effie (Frances Elizabeth Kennedy's sister-in-law). |
| 183 | 33 | BARTLETT, Joseph Grant (James's great-great-great-granddaughter's husband). |
| 95 | 33 | Tori Dawn (James's four-times-great-granddaughter). |
| 96 | 33 | Travis Darryl (James's four-times-great-grandson). |
| 97 | 33 | Trevor David (James's four-times-great-grandson). |
| 323 | 68 | BAYS, Margaret (James's great-grandson's wife). |
| 73 | 8 | BENNER, Toni (James's four-times-great-grandson's wife). |
| 129 | 10 | BENSON, Janice (James's great-great-great-grandson's wife). |
| 398 | | BERRYMAN, Freda Jean (John David Kelley's great-niece). |
| 396 | | Gilbert (John David Kelley's great-nephew). |
| 397 | | Julie Mae (John David Kelley's great-niece). |
| 395 | | Rosa e Mary (John David Kelley's great-niece). |
| 417 | | Tommy (John David Kelley's niece's husband). |
| 399 | | Tommy, II (John David Kelley's great-nephew). |
| 282 | 54 | BLACKBURN, Harvey Alton (James's great-great-granddaughter's husband). |
| 198 | 54 | Harvey David (James's great-great-great-grandson). |
| 196 | 54 | Katheryne Louize (James's great-great-great-granddaughter). |
| 146 | 18 | BLUNT, Al (James's great-great-great-granddaughter's husband). |
| 45 | 18 | Ed (James's four-times-great-grandson). |
| 44 | 18 | Katy Sue (James's four-times-great-granddaughter). |
| 586 | | BOICE, Ephriam (Anne Elizabeth Van Orsdel's grandfather). |
| 576 | | Jacob (Anne Elizabeth Van Orsdel's uncle). |
| 574 | | Katie (Anne Elizabeth Van Orsdel's aunt). |
| 572 | | Mary B (Anne Elizabeth Van Orsdel's aunt). |
| 571 | | Rebecca K (Anne Elizabeth Van Orsdel's mother). |
| 465 | | BOWLES, Amelia Frances (John David Kelley's grandmother). |
| 1 | 1 | BOYD, Caitlin Arlena (James's five-times-great-granddaughter). |
| 21 | 1 | James Vencent (James's four-times-great-granddaughter's husband). |
| 2 | 1 | Jason Alexander (James's five-times-great-grandson). |
| 356 | | BRANDENBURG, Casey (Betty Carol Fitzpatrick's niece's husband). |
| 137 | 14 | BRANT, Carol Lee (James's great-great-great-grandson's wife). |

| <u>Ref.</u> | <u>Tree</u> | <u>Name (Relationship)</u> |
|-------------|-------------|--|
| 255 | | BRAY, Mr. (James's great-great-granddaughter's husband). |
| 303 | | BRUGUS, Carol (James's great-great-grandson's wife). |
| 119 | 41 | CAIRNS, Brindi Michelle (James's four-times-great-granddaughter). |
| 228 | 60 | Christine Marie (James's great-great-great-granddaughter). |
| 117 | 41 | Dorci Kae (James's four-times-great-granddaughter). |
| 298 | 69 | Dorothy Lorraine (James's great-great-granddaughter). |
| 279 | | Douglas Turner (James's great-great-granddaughter's husband). |
| 232 | 60 | Elizabeth Kay (James's great-great-great-granddaughter). |
| 118 | 41 | Jace William (James's four-times-great-grandson). |
| 294 | 69 | Jack Lavoy (James's great-great-grandson). |
| 230 | 60 | Jack Lavoy, Jr. (James's great-great-great-grandson). |
| 299 | 69 | Judy Ann (James's great-great-granddaughter). |
| 226 | 60 | Linda Ann (James's great-great-great-granddaughter). |
| 325 | 69 | Logan Turner (James's great-granddaughter's husband). |
| 296 | 69 | Margaret Faunita (James's great-great-granddaughter). |
| 111 | 39 | Mary Melissa (James's four-times-great-granddaughter). |
| 110 | 39 | Rachel Elizabeth (James's four-times-great-granddaughter). |
| 236 | 60 | Rebecca Gay (James's great-great-great-granddaughter). |
| 234 | 60 | William Wayne (James's great-great-great-grandson). |
| 229 | 38 | CAMPBELL, Craig (James's great-great-great-granddaughter's husband). |
| 109 | 38 | Eric Raymond (James's four-times-great-grandson). |
| 108 | 38 | Holly Ann (James's four-times-great-granddaughter). |
| 107 | 38 | Triana Marie (James's four-times-great-granddaughter). |
| 231 | 39 | CASSLER, Rebecca (James's great-great-great-grandson's wife). |
| 552 | | CATTERSON, Sarah (Anne Elizabeth Van Orsdel's sister-in-law). |
| 195 | | CAYLOR, Roger (James's great-great-great-granddaughter's husband). |
| 25 | | CLARIDGE, Tom (James's four-times-great-granddaughter's husband). |
| 139 | | COOPTON, Vicki (James's great-great-great-grandson's wife). |
| 122 | 42 | COOPER, Hillary Rane (James's four-times-great-granddaughter). |
| 237 | 42 | John Ellery (James's great-great-great-granddaughter's husband). |
| 120 | 42 | Tiffany Anne (James's four-times-great-granddaughter). |
| 176 | 30 | CORLETT, Claudette Irene (James's great-great-great-grandson's wife). |
| 475 | | Claudette Irene (Bruce Douglas Whitman's wife). |
| 190 | | Everett Michael (James's great-great-great-granddaughter's husband). |
| 420 | | COX, Mr. (John David Kelley's niece's husband). |
| 206 | | Patricia (James's great-great-great-grandson's wife). |
| 62 | 22 | CURTIS, Anita Carol (James's four-times-great-granddaughter). |
| 72 | 22 | David Earl (James's four-times-great-grandson). |
| 19 | 8 | Ivie Ski (James's five-times-great-granddaughter). |
| 69 | 22 | Melony Jo (James's four-times-great-granddaughter). |
| 17 | 8 | Mercedes (James's five-times-great-granddaughter). |
| 157 | 22 | Norman Perry (James's great-great-great-granddaughter's husband). |
| 67 | 22 | Norman Perry, Jr. (James's four-times-great-grandson). |
| 18 | 8 | Savanna June (James's five-times-great-granddaughter). |
| 284 | 55 | DADISMAN, Norma Hilda (James's great-great-grandson's wife). |
| 287 | 67 | DAVIDSON, Charles Daniel (James's great-great-grandson). |
| 216 | 57 | Charles Noller (James's great-great-great-grandson). |
| 283 | 67 | Chester Clark (James's great-great-grandson). |
| 200 | 55 | Daniel Clark (James's great-great-great-grandson). |
| 213 | 57 | Deborah Jeane (James's great-great-great-granddaughter). |
| 285 | 67 | Eleanora Alice (James's great-great-granddaughter). |
| 321 | 67 | Fairfax Harry (James's great-granddaughter's husband). |
| 275 | 67 | Frances Amonda (James's great-great-granddaughter). |
| 201 | 55 | Jean Marie (James's great-great-great-granddaughter). |
| 281 | 67 | Louize Gertrude (James's great-great-granddaughter). |
| 289 | 67 | Myrtle Rae (James's great-great-granddaughter). |
| 211 | 57 | Suellen Louise (James's great-great-great-granddaughter). |
| 277 | 67 | Vita Maude (James's great-great-granddaughter). |
| 267 | 51 | DEBERNARDI, Joan Olivia (James's great-great-grandson's wife). |
| 563 | | DIEHL, Noah (Anne Elizabeth Van Orsdel's brother-in-law). |
| 144 | 17 | DOLLAR HYDE, Ellen (James's great-great-great-grandson's wife). |
| 547 | | EAGOR, Mary (Frances Elizabeth Kennedy's great-grandmother). |

| <u>Ref.</u> | <u>Tree</u> | <u>Name (Relationship)</u> |
|-------------|-------------|--|
| 435 | | EARLYWINE, Betty (John David Kelley's sister-in-law). |
| 222 | | FERRIN, Richard (James's great-great-great-granddaughter's husband). |
| 354 | | FITZPATRICK, A J (Betty Carol Fitzpatrick's nephew). |
| 155 | 21 | Betty Carol (James's great-great-great-grandson's wife). |
| 372 | | Edward S (Pete) (Betty Carol Fitzpatrick's father). |
| 370 | | Sandra Darlene (Betty Carol Fitzpatrick's sister). |
| 352 | | Tammy Lynn (Betty Carol Fitzpatrick's niece). |
| 366 | | Tempie Ann (Betty Carol Fitzpatrick's sister). |
| 351 | | Terri Lyn (Betty Carol Fitzpatrick's niece). |
| 353 | | Virginia Ruth (Betty Carol Fitzpatrick's niece). |
| 375 | | William Allen (Betty Carol Fitzpatrick's grandfather). |
| 362 | | William Terry (Betty Carol Fitzpatrick's brother). |
| 86 | 24 | FORRESTER, Jamie (James's four-times-great-granddaughter). |
| 164 | 24 | Micheal A (James's great-great-great-granddaughter's husband). |
| 84 | 24 | Mike Allen, Jr. (James's four-times-great-grandson). |
| 85 | 24 | Tommy James (James's four-times-great-grandson). |
| 131 | 11 | GEPPERT, August Henry (James's great-great-great-granddaughter's husband). |
| 30 | 11 | Judy Arlene (James's four-times-great-granddaughter). |
| 28 | 11 | Lori Ann (James's four-times-great-granddaughter). |
| 32 | 11 | Tommy Duane (James's four-times-great-grandson). |
| 367 | | GLIPSEY, Johnny (Betty Carol Fitzpatrick's brother-in-law). |
| 379 | | GULETT, John W (Betty Carol Fitzpatrick's great-grandfather). |
| 377 | | Millard (Betty Carol Fitzpatrick's grandfather). |
| 374 | | Virginia Ruth (Betty Carol Fitzpatrick's mother). |
| 113 | 40 | HANSEN, Aaron Wayne (James's four-times-great-grandson). |
| 233 | 40 | Alan (James's great-great-great-granddaughter's husband). |
| 115 | 40 | Amy Nicole (James's four-times-great-granddaughter). |
| 116 | 40 | Jacob Karl (James's four-times-great-grandson). |
| 112 | 40 | Jeremy Alan (James's four-times-great-grandson). |
| 114 | 40 | Michael Brent (James's four-times-great-grandson). |
| 205 | | HARDING, Kay (James's great-great-great-grandson's wife). |
| 290 | 58 | HARNED, David Debernardi (James's great-great-granddaughter's husband). |
| 218 | 58 | Keren Lynne (James's great-great-great-granddaughter). |
| 61 | 13 | HAYES, Bob (James's four-times-great-grandson). |
| 135 | 13 | Bob (James's great-great-great-granddaughter's husband). |
| 71 | 13 | Karen (James's four-times-great-granddaughter). |
| 66 | 13 | Linda (James's four-times-great-granddaughter). |
| 70 | 13 | Toby (James's four-times-great-grandson). |
| 327 | 70 | HENDERSON, Inez (James's great-grandson's wife). |
| 558 | | HEWITT, William B (Anne Elizabeth Van Orsdel's brother-in-law). |
| 121 | | HIX, Steve (James's four-times-great-granddaughter's husband). |
| 199 | | HOFFMAN, Celeste Marie (James's great-great-great-grandson's wife). |
| 133 | 12 | HUBBARD, Rosa L (James's great-great-great-grandson's wife). |
| 349 | 74 | HUDSON, Sarah (James's wife). |
| 9 | 4 | HUNNICUTT, Christian David (James's five-times-great-grandson). |
| 53 | 4 | Cristian (James's four-times-great-granddaughter's husband). |
| 381 | | HUTCHCHISON, Andy (Betty Carol Fitzpatrick's great-grandfather). |
| 378 | | Cora Elizabeth (Betty Carol Fitzpatrick's grandmother). |
| 523 | | JARVIS, Lydia (Frances Elizabeth Kennedy's aunt by marriage). |
| 241 | 43 | JEBENS, Carlie (James's great-great-great-granddaughter's husband). |
| 125 | 43 | Carlie Norman (James's four-times-great-grandson). |
| 124 | 43 | Korey Kay (James's four-times-great-granddaughter). |
| 123 | 43 | Kreetta Ann (James's four-times-great-granddaughter). |
| 217 | | JENKINS, Tonia (James's great-great-great-grandson's wife). |
| 305 | | JENNINGS, John (James's great-great-granddaughter's husband). |
| 295 | 60 | JOHNSON, Beverly Ann (James's great-great-grandson's wife). |
| 162 | 23 | Gordon (James's great-great-great-granddaughter's husband). |
| 264 | 49 | Gordon (James's great-great-granddaughter's husband). |
| 82 | 23 | Gordon Scott (Scotty) (James's four-times-great-grandson). |
| 23 | 2 | Kim Eileen (James's four-times-great-grandson's wife). |
| 467 | | Margaret (John David Kelley's grandmother). |
| 159 | 49 | Scott (James's great-great-great-grandson). |

| <u>Ref.</u> | <u>Tree</u> | <u>Name (Relationship)</u> |
|-------------|-------------|--|
| 158 | 49 | JOHNSON, Stanley (James's great-great-great-grandson). |
| 83 | 23 | Stanley (Stan) (James's four-times-great-grandson). |
| 221 | | Timothy Tol (James's great-great-great-granddaughter's husband). |
| 59 | 21 | JONES, Sherrie (Like a Daughter) (James's four-times-great-granddaughter). |
| 34 | 3 | JORGENSEN, Joyce Ellen (James's four-times-great-grandson's wife). |
| 181 | 32 | JOUETT, Robin Knipp (James's great-great-great-grandson's wife). |
| 405 | | KELLEY, Amanda (John David Kelley's great-niece). |
| 56 | 21 | Anna Carol (James's four-times-great-granddaughter). |
| 429 | | Aquilla David (John David Kelley's nephew). |
| 436 | | Aquilla Durham (John David Kelley's brother). |
| 449 | | Betty Jane (John David Kelley's aunt). |
| 431 | | Beverly (John David Kelley's niece). |
| 425 | | Billy Dean (John David Kelley's nephew). |
| 406 | | Billy Dean (John David Kelley's great-nephew). |
| 385 | | Bobby Gene (John David Kelley's great-nephew). |
| 421 | | Brenda Jane (John David Kelley's niece). |
| 156 | 48 | Carolyn June (James's great-great-great-granddaughter). |
| 418 | | Cristine Faye (John David Kelley's niece). |
| 424 | | Donnie Lee (John David Kelley's nephew). |
| 407 | | Dorthy Mae (John David Kelley's niece). |
| 472 | | Edward (John David Kelley's great-great-great-grandfather). |
| 470 | | Erasmus E (John David Kelley's great-great-grandfather). |
| 409 | | Eugene (John David Kelley's nephew). |
| 423 | | Freddie Warren (John David Kelley's nephew). |
| 445 | | Herbert (John David Kelley's uncle). |
| 446 | | Herman (John David Kelley's uncle). |
| 432 | | James Luther (John David Kelley's brother). |
| 422 | | James Luther, Jr. (John David Kelley's nephew). |
| 262 | 48 | John David (James's great-great-granddaughter's husband). |
| 411 | | Juanita (John David Kelley's niece). |
| 464 | | Lewis Lute (John David Kelley's grandfather). |
| 52 | 21 | Lisa June (James's four-times-great-granddaughter). |
| 598 | | Lou (Betty Earlywine's mother). |
| 447 | | Mabel (John David Kelley's aunt). |
| 414 | | Mary Elizabeth (John David Kelley's niece). |
| 430 | | Mary Lou (John David Kelley's niece). |
| 428 | | Mildred Ann (John David Kelley's niece). |
| 444 | | Milton Varso (John David Kelley's uncle). |
| 58 | 21 | Ronald David, Jr. (James's four-times-great-grandson). |
| 154 | 48 | Ronald David, Sr. (James's great-great-great-grandson). |
| 450 | | Silverine (John David Kelley's aunt). |
| 442 | | Talmadge Blane (John David Kelley's father). |
| 434 | | Talmadge Blane, Jr. (John David Kelley's brother). |
| 416 | | Wanda Lou (John David Kelley's niece). |
| 427 | | William Blaine (John David Kelley's nephew). |
| 468 | | William S (John David Kelley's great-grandfather). |
| 8 | 3 | KENNADAY, Aaron Forest (James's five-times-great-grandson). |
| 7 | 3 | Adam Malaki (James's five-times-great-grandson). |
| 346 | 74 | Alice (James's daughter). |
| 274 | 66 | Alice Ann (James's great-great-granddaughter). |
| 320 | 71 | Alice Oda May (James's great-granddaughter). |
| 312 | 71 | Alonso (James's great-grandson). |
| 337 | 73 | Andrew Jackson (James's grandson). |
| 310 | 71 | Anna Ruth (James's great-granddaughter). |
| 335 | 73 | Anne E D (James's granddaughter). |
| 81 | 28 | Anthony Joseph (James's four-times-great-grandson). |
| 345 | 74 | Axie (James's daughter). |
| 263 | 65 | Bonnie Jean (James's great-great-granddaughter). |
| 302 | 70 | Carl L (James's great-great-grandson). |
| 271 | 66 | Catherine Marie (James's great-great-granddaughter). |
| 329 | 73 | Charles Alonzo (James's grandson). |
| 322 | 71 | Charles Fredrick (James's great-grandson). |

| <u>Ref.</u> | <u>Tree</u> | <u>Name (Relationship)</u> |
|-------------|-------------|---|
| 126 | 44 | KENNADAY, Charlotte Arlene (James's great-great-great-granddaughter). |
| 76 | 25 | Cristina Dianne (James's four-times-great-granddaughter). |
| 35 | 14 | Darren (James's four-times-great-grandson). |
| 167 | 51 | David Debernardi (James's great-great-great-grandson). |
| 306 | 70 | Donald Fay (James's great-great-grandson). |
| 318 | 71 | Edward Thomas (James's great-grandson). |
| 75 | 25 | Elizabeth Alta Olivia (James's four-times-great-granddaughter). |
| 336 | 73 | Emma H (James's granddaughter). |
| 324 | 71 | Emma Helen (James's great-granddaughter). |
| 328 | 72 | Fay (James's great-granddaughter). |
| 254 | 65 | Florence Mae (James's great-great-granddaughter). |
| 257 | 65 | Forest Jack (James's great-great-grandson). |
| 292 | 68 | Frances Ann (James's great-great-granddaughter). |
| 316 | 71 | Frank Forest (James's great-grandson). |
| 272 | 66 | Fred E (James's great-great-grandson). |
| 172 | 51 | Fredrick Frank (James's great-great-great-grandson). |
| 138 | 46 | Gary Forrest (James's great-great-great-grandson). |
| 165 | 51 | Gary Jo (James's great-great-great-grandson). |
| 314 | 71 | Harry Otis (James's great-grandson). |
| 313 | 71 | Henry George (James's great-grandson). |
| 332 | 73 | Ida Jane (James's granddaughter). |
| 261 | 65 | Iva June (James's great-great-granddaughter). |
| 301 | 70 | Jack J (James's great-great-grandson). |
| 136 | 46 | Jack Wayne (James's great-great-great-grandson). |
| 348 | 74 | James (The subject of this report). |
| 273 | 66 | James (James's great-great-grandson). |
| 331 | 73 | James Edward (James's grandson). |
| 37 | 16 | Jeffrey Michael (James's four-times-great-grandson). |
| 269 | 66 | John E (James's great-great-grandson). |
| 340 | 74 | John Hudson (James's son). |
| 334 | 73 | John W (James's grandson). |
| 339 | 74 | Joseph Bryson (James's son). |
| 347 | 74 | Joseph Wright (James's son). |
| 77 | 26 | Joshua Jolin (James's four-times-great-grandson). |
| 304 | 70 | Joy L (James's great-great-granddaughter). |
| 26 | 10 | Karla Lynn (James's four-times-great-granddaughter). |
| 27 | 10 | Kathy Kay (James's four-times-great-granddaughter). |
| 36 | 15 | Kelly Michele (James's four-times-great-granddaughter). |
| 266 | 65 | Lincoln Frank (James's great-great-grandson). |
| 326 | 72 | Loyd Andrew (James's great-grandson). |
| 78 | 27 | Mallory (James's four-times-great-granddaughter). |
| 270 | 66 | Mary Lou (James's great-great-granddaughter). |
| 333 | 73 | Mary V (James's granddaughter). |
| 343 | 74 | Mary Vicker (James's daughter). |
| 141 | 46 | Michael Joseph (James's great-great-great-grandson). |
| 74 | 25 | Nicholas Isaiah (James's four-times-great-grandson). |
| 80 | 28 | Patricia Leigh (James's four-times-great-granddaughter). |
| 130 | 44 | Patty Ray (James's great-great-great-granddaughter). |
| 344 | 74 | Rachel A (James's daughter). |
| 79 | 27 | Reed (James's four-times-great-grandson). |
| 308 | 71 | Rosa Marie (James's great-granddaughter). |
| 259 | 65 | Rose Marie (James's great-great-granddaughter). |
| 307 | 71 | Sarah Elizabeth (James's great-granddaughter). |
| 169 | 51 | Steven Scott (James's great-great-great-grandson). |
| 252 | 65 | Thomas Earl (James's great-great-grandson). |
| 128 | 44 | Thomas Eugene (James's great-great-great-grandson). |
| 33 | 14 | Todd (James's four-times-great-grandson). |
| 268 | 66 | William C (James's great-great-grandson). |
| 342 | 74 | Zarilda (James's daughter). |
| 487 | | KENNEDY, Addie (Frances Elizabeth Kennedy's niece). |
| 484 | | Alvin (Frances Elizabeth Kennedy's nephew). |
| 503 | | Andrew (Frances Elizabeth Kennedy's brother). |

| <u>Ref.</u> | <u>Tree</u> | <u>Name (Relationship)</u> |
|-------------|-------------|---|
| 485 | | KENNEDY, Bearthey (Frances Elizabeth Kennedy's nephew). |
| 518 | | Christine (Frances Elizabeth Kennedy's aunt). |
| 495 | | Clarence Bland (Frances Elizabeth Kennedy's nephew). |
| 483 | | Eddie (Frances Elizabeth Kennedy's nephew). |
| 527 | | Elizabeth (Frances Elizabeth Kennedy's aunt). |
| 497 | | Emaline (Frances Elizabeth Kennedy's sister). |
| 524 | | Emiline (Frances Elizabeth Kennedy's aunt). |
| 330 | 71 | Frances Elizabeth (James's grandson's wife). |
| 490 | | Fredrick Fay (Frances Elizabeth Kennedy's nephew). |
| 510 | | George Washington (Frances Elizabeth Kennedy's brother). |
| 519 | | Jacob (Frances Elizabeth Kennedy's uncle). |
| 507 | | James Franklin (Frances Elizabeth Kennedy's brother). |
| 520 | | James Leighton (Frances Elizabeth Kennedy's uncle). |
| 488 | | Jesse Rufus (Frances Elizabeth Kennedy's nephew). |
| 514 | | Jesse Rufus (Frances Elizabeth Kennedy's father). |
| 540 | | John (Frances Elizabeth Kennedy's grandfather). |
| 501 | | John Ronnie (Frances Elizabeth Kennedy's brother). |
| 522 | | Jonn (Frances Elizabeth Kennedy's uncle). |
| 493 | | Lillie Irene (Frances Elizabeth Kennedy's niece). |
| 482 | | Marcy (Frances Elizabeth Kennedy's niece). |
| 498 | | Mariah (Frances Elizabeth Kennedy's sister). |
| 500 | | Nanch Isabell (Frances Elizabeth Kennedy's sister). |
| 516 | | Nancy (Frances Elizabeth Kennedy's aunt). |
| 528 | | Rebecca (Frances Elizabeth Kennedy's aunt). |
| 491 | | Sadie Bell (Frances Elizabeth Kennedy's niece). |
| 525 | | Samuel (Frances Elizabeth Kennedy's uncle). |
| 505 | | Samuel Rufus (Frances Elizabeth Kennedy's brother). |
| 526 | | Sarah Jane (Frances Elizabeth Kennedy's aunt). |
| 512 | | Sarah Jane (Frances Elizabeth Kennedy's sister). |
| 486 | | Willber (Frances Elizabeth Kennedy's nephew). |
| 544 | | William (Frances Elizabeth Kennedy's great-grandfather). |
| 509 | | William Edson (Frances Elizabeth Kennedy's brother). |
| 210 | | KURTH, Nancy Sue (James's great-great-great-grandson's wife). |
| 481 | | LAMBS- COBB, Mary Adele (Mable Pierce's mother). |
| 170 | 26 | LAVELLE, Catherine Susan (James's great-great-great-grandson's wife). |
| 16 | 7 | LETT, Cory (James's five-times-great-grandson). |
| 15 | 7 | Sara (James's five-times-great-granddaughter). |
| 63 | 7 | Tim (James's four-times-great-granddaughter's husband). |
| 14 | 7 | Tim (James's five-times-great-grandson). |
| 260 | 47 | LOTT, Calvin (James's great-great-granddaughter's husband). |
| 43 | 18 | Calvin E Terett (James's four-times-great-grandson). |
| 147 | 47 | Calvin Jay (James's great-great-great-grandson). |
| 38 | 17 | Delera Kay (James's four-times-great-granddaughter). |
| 47 | 19 | Diana (James's four-times-great-granddaughter). |
| 143 | 47 | Jimmy Ray (James's great-great-great-grandson). |
| 152 | 47 | John (James's great-great-great-grandson). |
| 46 | 19 | John Frank (James's four-times-great-grandson). |
| 39 | 17 | Kathy Ann (James's four-times-great-granddaughter). |
| 42 | 18 | Lee Ann Marie (James's four-times-great-granddaughter). |
| 40 | 17 | MAnnett Marie (James's four-times-great-granddaughter). |
| 149 | 47 | Mable Bea (James's great-great-great-granddaughter). |
| 48 | 19 | Michele (James's four-times-great-granddaughter). |
| 153 | 47 | Randy Eugene (James's great-great-great-grandson). |
| 145 | 47 | Rosa Lee (James's great-great-great-granddaughter). |
| 41 | 17 | Roxy Ann (James's four-times-great-granddaughter). |
| 293 | | LUCAS, Thomas Dean (James's great-great-granddaughter's husband). |
| 476 | | MADDEN, Lorraine (Bruce Douglas Whitman's wife). |
| 177 | | Lorraine (James's great-great-great-grandson's wife). |
| 319 | 66 | MANNAHAN, Alice (James's great-grandson's wife). |
| 265 | 50 | MARIER, James Martin (James's great-great-granddaughter's husband). |
| 163 | 50 | Jane Marie (James's great-great-great-granddaughter). |
| 160 | 50 | Sherry Jean (James's great-great-great-granddaughter). |

| <u>Ref.</u> | <u>Tree</u> | <u>Name (Relationship)</u> |
|-------------|-------------|---|
| 338 | 72 | MARSHEL, Anna (James's grandson's wife). |
| 502 | | MARTINDALE, Nancy Alice (Frances Elizabeth Kennedy's sister-in-law). |
| 212 | | MASTERS, John Ellery (James's great-great-great-granddaughter's husband). |
| 554 | | MATOXX, Sallie (Anne Elizabeth Van Orsdel's sister-in-law). |
| 471 | | MC IWOAN, Mary (John David Kelley's great-great-grandmother). |
| 451 | | MC RUTHER, Tonm (John David Kelley's uncle by marriage). |
| 489 | | MCCLURE, Fay (Frances Elizabeth Kennedy's nephew's wife). |
| 492 | | Jay (Frances Elizabeth Kennedy's niece's husband). |
| 197 | | MCCREA, Edward J (James's great-great-great-granddaughter's husband). |
| 13 | 6 | MEYER, Cody (James's five-times-great-grandson). |
| 12 | 6 | Kayla (James's five-times-great-granddaughter). |
| 60 | 6 | Mark (James's four-times-great-granddaughter's husband). |
| 457 | | MINTON, Carrie (John David Kelley's aunt). |
| 452 | | Della (John David Kelley's aunt). |
| 463 | | Ethel (John David Kelley's aunt). |
| 454 | | Ida Catherine (John David Kelley's aunt). |
| 453 | | Isabell May (John David Kelley's aunt). |
| 455 | | James (John David Kelley's uncle). |
| 466 | | James M (John David Kelley's grandfather). |
| 456 | | Maggie (John David Kelley's aunt). |
| 443 | | Mary Elizabeth (John David Kelley's mother). |
| 460 | | Phillys (John David Kelley's aunt). |
| 459 | | Rosayella (John David Kelley's aunt). |
| 462 | | Walter (John David Kelley's uncle). |
| 568 | | MITCHELL, Annie E (Anne Elizabeth Van Orsdel's sister-in-law). |
| 373 | | MONTGOMERY, Cecil Ray (Betty Carol Fitzpatrick's mother's husband). |
| 364 | | MULBERRY, Brenda Faye (Betty Carol Fitzpatrick's sister-in-law). |
| 473 | | MULL, America (John David Kelley's great-great-grandmother). |
| 413 | | MYERS, Mr. (John David Kelley's niece's husband). |
| 214 | | NATION, Charles William, Jr. (James's great-great-great-granddaughter's husband). |
| 288 | 57 | NOLLER, Earlene Dee (James's great-great-grandson's wife). |
| 376 | | OSBURN, Betty Jack (Betty Carol Fitzpatrick's grandmother). |
| 106 | 37 | PAGE, Donald Grant (James's four-times-great-grandson). |
| 105 | 37 | Johnathan Jack (James's four-times-great-grandson). |
| 227 | 37 | Ronald Otis (James's great-great-great-granddaughter's husband). |
| 104 | 37 | Thomas Elliott (James's four-times-great-grandson). |
| 151 | | PATCHINS, Lawrence P (James's great-great-great-granddaughter's husband). |
| 477 | | PEARCE, Alice (Mable Pierce's sister). |
| 479 | | Thomas Earl (Mable Pierce's father). |
| 175 | 29 | PENDERGRASS, Cecelia Kay (James's great-great-grandson's wife). |
| 494 | | PERRY, Elmer (Frances Elizabeth Kennedy's niece's husband). |
| 309 | 63 | PETERS, Fred (James's great-granddaughter's husband). |
| 244 | 63 | Grace (James's great-great-granddaughter). |
| 245 | 63 | John (James's great-great-grandson). |
| 65 | | PHELPS, Mike (James's four-times-great-granddaughter's husband). |
| 480 | | PHIPPS, James (Mable Pierce's mother's husband). |
| 478 | | Virgie (Mable Pierce's half-sister). |
| 317 | 65 | PIERCE, Mable (James's great-grandson's wife). |
| 560 | | POLLARD, John Benjamin (Anne Elizabeth Van Orsdel's brother-in-law). |
| 235 | 41 | PORTER, Kae (James's great-great-great-grandson's wife). |
| 394 | | PRUITT, Allen Todd (John David Kelley's great-nephew). |
| 392 | | Cristine Mae (John David Kelley's great-niece). |
| 390 | | Danny James (John David Kelley's great-nephew). |
| 415 | | Harold Lee (John David Kelley's niece's husband). |
| 389 | | Haroled Lee, Jr. (John David Kelley's great-nephew). |
| 393 | | Michael Cameron (John David Kelley's great-nephew). |
| 391 | | Ruth Ann (John David Kelley's great-nephew). |
| 51 | 12 | RAMSEY (ADOPTED), Michale (James's four-times-great-grandson). |
| 134 | 45 | RAMSEY, Afton Ernstine (Marier) (James's great-great-great-granddaughter). |
| 132 | 45 | Earl Efton (Butch) (James's great-great-great-grandson). |
| 256 | 45 | Earl N (James's great-great-granddaughter's husband). |
| 55 | 12 | Melinda (adopted) (James's four-times-great-granddaughter). |

| <u>Ref.</u> | <u>Tree</u> | <u>Name (Relationship)</u> |
|-------------|-------------|---|
| 545 | | RAYNOR, Jake (Frances Elizabeth Kennedy's great-grandfather). |
| 541 | | Sarah Jane (Frances Elizabeth Kennedy's grandmother). |
| 253 | 44 | REAM, Gladys Eleanor (James's great-great-grandson's wife). |
| 220 | 59 | REDMAN, Kathleen Marie (James's great-great-great-granddaughter). |
| 224 | 59 | Kathryn Victoria (James's great-great-great-granddaughter). |
| 291 | 59 | Ronald Clark (James's great-great-granddaughter's husband). |
| 225 | 59 | Ronnie Wesley (James's great-great-great-grandson). |
| 171 | 27 | REED, Danielle (James's great-great-great-grandson's wife). |
| 521 | | RHINEHEART, Elizabeth (Frances Elizabeth Kennedy's aunt by marriage). |
| 166 | | RHOADS, Rita Dianne (James's great-great-great-grandson's wife). |
| 562 | | ROGERS, Thomas (Anne Elizabeth Van Orsdel's brother-in-law). |
| 192 | 53 | ROGERSON, Robert Harry (James's great-great-great-grandson). |
| 278 | 53 | Robert Orrin (James's great-great-granddaughter's husband). |
| 194 | 53 | Ruth Orrine (James's great-great-great-granddaughter). |
| 193 | 53 | Wilma Elaine (James's great-great-great-granddaughter). |
| 575 | | RYNEARSON, Samuel (Anne Elizabeth Van Orsdel's uncle by marriage). |
| 458 | | SADLER, Mr. (John David Kelley's uncle by marriage). |
| 438 | | Raymond (John David Kelley's cousin). |
| 593 | | SAPP, Archie (Cristine Sapp's brother). |
| 595 | | Clara Belle (Cristine Sapp's sister). |
| 433 | | Cristine (John David Kelley's sister-in-law). |
| 591 | | Everett (Cristine Sapp's brother). |
| 596 | | John Harvey (Cristine Sapp's father). |
| 592 | | Lizzie (Cristine Sapp's sister). |
| 594 | | Roy (Cristine Sapp's brother). |
| 280 | | SCHILLING, Vyril M (James's great-great-granddaughter's husband). |
| 243 | 62 | SCHMELING, Amy Nichole (James's great-great-great-granddaughter). |
| 300 | 62 | Craig Martin (James's great-great-granddaughter's husband). |
| 242 | 62 | Tyler Martin (James's great-great-great-grandson). |
| 161 | | SCHOENWALD, Jim (James's great-great-great-granddaughter's husband). |
| 581 | | SCOMP, Annie E (Anne Elizabeth Van Orsdel's aunt). |
| 578 | | George (Anne Elizabeth Van Orsdel's uncle). |
| 583 | | Hanna (Anne Elizabeth Van Orsdel's aunt). |
| 580 | | Henry (Anne Elizabeth Van Orsdel's uncle). |
| 588 | | Jacob (Anne Elizabeth Van Orsdel's grandmother's husband). |
| 579 | | John (Anne Elizabeth Van Orsdel's uncle). |
| 582 | | Sally (Anne Elizabeth Van Orsdel's aunt). |
| 384 | | SCOTT, Donna (John David Kelley's great-niece). |
| 383 | | Gary (John David Kelley's great-nephew). |
| 408 | | Pete (John David Kelley's niece's husband). |
| 103 | 36 | SELF, Ashley Chester (James's four-times-great-grandson). |
| 102 | 36 | Ian Mathew (James's four-times-great-grandson). |
| 189 | 36 | Stanley Howard (James's great-great-great-granddaughter's husband). |
| 101 | 36 | Stuart Branson (James's four-times-great-grandson). |
| 549 | | SELLERS, Elizabeth (Frances Elizabeth Kennedy's great-grandmother). |
| 363 | | SHAW, Linda D (Betty Carol Fitzpatrick's sister-in-law). |
| 517 | | SHEPHERD, Benjamin Kirk (Frances Elizabeth Kennedy's uncle by marriage). |
| 499 | | SHIDLER, Alferd (Frances Elizabeth Kennedy's brother-in-law). |
| 223 | | SHOEMAKER, Jamie Paul (James's great-great-great-granddaughter's husband). |
| 380 | | SIZMOORE, Cynthia (Betty Carol Fitzpatrick's great-grandmother). |
| 589 | | SKELTON, James Franklin (Mary Elizabeth Skelton's father). |
| 511 | | Mary Elizabeth (Frances Elizabeth Kennedy's sister-in-law). |
| 50 | 20 | SLOANE, Larry (James's four-times-great-grandson). |
| 49 | 20 | Lisa (James's four-times-great-granddaughter). |
| 150 | 20 | Mr. (James's great-great-great-granddaughter's husband). |
| 469 | | SMITH, Elizabeth (John David Kelley's great-grandmother). |
| 187 | 35 | Fred Winton (James's great-great-great-granddaughter's husband). |
| 99 | 35 | Fred Winton (James's four-times-great-grandson). |
| 168 | 25 | Paula Jo (James's great-great-great-grandson's wife). |
| 587 | | SMOCK, Mary Vicker (Anne Elizabeth Van Orsdel's grandmother). |
| 20 | 9 | SOBO, Brenda Sue (James's four-times-great-granddaughter). |
| 127 | 9 | Cornell Alexander, Jr. (James's great-great-great-granddaughter's husband). |

| <u>Ref.</u> | <u>Tree</u> | <u>Name (Relationship)</u> |
|-------------|-------------|---|
| 4 | 2 | SOBO, Julie Erin (James's five-times-great-granddaughter). |
| 3 | 2 | Justin Kyle (James's five-times-great-grandson). |
| 22 | 9 | Randy Eugene (James's four-times-great-grandson). |
| 24 | 9 | Teresa Lynn (James's four-times-great-granddaughter). |
| 5 | 2 | Travis Andrew (James's five-times-great-grandson). |
| 6 | 2 | Tyler Jamison (James's five-times-great-grandson). |
| 64 | | STAMPS, George (James's four-times-great-granddaughter's husband). |
| 250 | 64 | STEWART, Charles Leroy (James's great-great-grandson). |
| 311 | 64 | Ed (James's great-granddaughter's husband). |
| 247 | 64 | Frances Luella (James's great-great-granddaughter). |
| 248 | 64 | George Martin (James's great-great-grandson). |
| 246 | 64 | Mable Vilote (James's great-great-granddaughter). |
| 249 | 64 | Olive Ruth (James's great-great-granddaughter). |
| 258 | 46 | STOCKWELL, Ellen (Dude) (James's great-great-granddaughter's husband). |
| 148 | 19 | STURGESS, Jo Ann (James's great-great-great-grandson's wife). |
| 382 | | THOMAS, Lana (Betty Carol Fitzpatrick's great-grandmother). |
| 140 | 15 | THOMPSON, Alice (James's great-great-great-grandson's wife). |
| 98 | 34 | Bradly Tommy (James's four-times-great-grandson). |
| 179 | 31 | Carolyn M (James's great-great-great-grandson's wife). |
| 371 | | Charles Raymond (Betty Carol Fitzpatrick's brother-in-law). |
| 360 | | Charles Raymond, Jr. (Betty Carol Fitzpatrick's nephew). |
| 361 | | Donna Denice (Betty Carol Fitzpatrick's niece). |
| 185 | 34 | Tommy M (James's great-great-great-granddaughter's husband). |
| 556 | | THORNHELL, Reubin (Anne Elizabeth Van Orsdel's brother-in-law). |
| 215 | | TOMAYER, Gerald Noller (James's great-great-great-granddaughter's husband). |
| 419 | | TREADWAY, Mr. (John David Kelley's niece's husband). |
| 506 | | TREDWAY, Lillie (Frances Elizabeth Kennedy's sister-in-law). |
| 496 | | UNKNOWN, Alice (Frances Elizabeth Kennedy's nephew's wife). |
| 68 | | Barbara (James's four-times-great-grandson's wife). |
| 441 | | Bill Tom (John David Kelley's cousin). |
| 401 | | Billy Joe (John David Kelley's great-nephew). |
| 400 | | Bonnie Sue (John David Kelley's great-niece). |
| 359 | | Brian (Betty Carol Fitzpatrick's niece's husband). |
| 386 | | Charles (John David Kelley's great-nephew). |
| 403 | | Chip (John David Kelley's great-nephew). |
| 387 | | Clarence (John David Kelley's great-nephew). |
| 388 | | Elizabeth Faye (John David Kelley's great-niece). |
| 585 | | Ellen (Anne Elizabeth Van Orsdel's grandmother). |
| 440 | | Eugene (John David Kelley's cousin). |
| 439 | | James (John David Kelley's cousin). |
| 350 | | Jaydon (Betty Carol Fitzpatrick's great-nephew). |
| 402 | | Jimmy (John David Kelley's great-nephew). |
| 365 | | Karen (Betty Carol Fitzpatrick's sister-in-law). |
| 404 | | Kim (John David Kelley's great-niece). |
| 251 | | Lucy (James's great-great-grandson's wife). |
| 590 | | Mary Jane (Mary Elizabeth Skelton's mother). |
| 597 | | Mary Miranda (Cristine Sapp's mother). |
| 461 | | Mr. (John David Kelley's uncle by marriage). |
| 426 | | Ms. (John David Kelley's nephew's wife). |
| 410 | | Opal (John David Kelley's nephew's wife). |
| 543 | | Ruth (Frances Elizabeth Kennedy's grandmother). |
| 564 | | VAN ORSDEL, Abram (Anne Elizabeth Van Orsdel's brother). |
| 570 | | Abram F, Jr. (Anne Elizabeth Van Orsdel's father). |
| 584 | | Abram Van Orsdel (Anne Elizabeth Van Orsdel's grandfather). |
| 341 | 73 | Anne Elizabeth (James's daughter-in-law). |
| 567 | | Henery George (Anne Elizabeth Van Orsdel's brother). |
| 565 | | Isabell (Anne Elizabeth Van Orsdel's sister). |
| 553 | | James H (Anne Elizabeth Van Orsdel's brother). |
| 555 | | Mary B (Anne Elizabeth Van Orsdel's sister). |
| 559 | | Melinda Catherine (Anne Elizabeth Van Orsdel's sister). |
| 557 | | Rebecca Ellen (Anne Elizabeth Van Orsdel's sister). |
| 561 | | Sarah E (Anne Elizabeth Van Orsdel's sister). |

| <u>Ref.</u> | <u>Tree</u> | <u>Name (Relationship)</u> |
|-------------|-------------|--|
| 551 | | VAN ORSDEL, William George (Anne Elizabeth Van Orsdel's brother). |
| 577 | | VAN ORSEDEL, Jane (Anne Elizabeth Van Orsdel's aunt by marriage). |
| 566 | | WALLACE, James H (Anne Elizabeth Van Orsdel's brother-in-law). |
| 412 | | WALTON, Mr. (John David Kelley's niece's husband). |
| 315 | | WEIBEL, Ester (James's great-grandson's wife). |
| 219 | | WELLS, Richard Lee (James's great-great-great-granddaughter's husband). |
| 57 | | WERT, Gregory (James's four-times-great-granddaughter's husband). |
| 29 | | WHITE, David Lester (James's four-times-great-granddaughter's husband). |
| 508 | | WHITED, Louise (Frances Elizabeth Kennedy's sister-in-law). |
| 178 | 52 | WHITMAN, Boyd David (James's great-great-great-grandson). |
| 276 | 52 | Bruce Douglas (James's great-great-great-granddaughter's husband). |
| 191 | 52 | Charles (James's great-great-great-grandson). |
| 182 | 52 | Charlotte Louize (James's great-great-great-granddaughter). |
| 100 | 35 | Collin Wade (James's four-times-great-grandson). |
| 94 | 32 | Gail Robin (James's four-times-great-granddaughter). |
| 93 | 32 | Grant Douglas (James's four-times-great-grandson). |
| 188 | 52 | Laurel Alice (James's great-great-great-granddaughter). |
| 184 | 52 | Marcella Ann (James's great-great-great-granddaughter). |
| 474 | | Marcus Pine (Bruce Douglas Whitman's son). |
| 89 | 30 | Marcus Pine (James's four-times-great-grandson). |
| 90 | 31 | Micheal Gerald Sturm (James's four-times-great-grandson). |
| 92 | 31 | Nathanielle Rebecca (James's four-times-great-granddaughter). |
| 174 | 52 | Nelson Chester (James's great-great-great-grandson). |
| 91 | 31 | Patrick Keith (James's four-times-great-grandson). |
| 88 | 29 | Peri Ann (James's four-times-great-granddaughter). |
| 186 | 52 | Phillis Lana (James's great-great-great-granddaughter). |
| 180 | 52 | Richard Ward (James's great-great-great-grandson). |
| 87 | 29 | Robbyn Cherter (James's four-times-great-grandson). |
| 355 | | WILLIAMS, Candice Machael (Betty Carol Fitzpatrick's niece). |
| 142 | 16 | Carolyn (James's great-great-great-grandson's wife). |
| 550 | | John (Anne Elizabeth Van Orsdel's husband). |
| 368 | | Robert Therman (Betty Carol Fitzpatrick's brother-in-law). |
| 297 | 61 | WILSON, Albert Norman (James's great-great-granddaughter's husband). |
| 239 | 61 | Kenneth Logan (James's great-great-great-grandson). |
| 240 | 61 | Phyllis Ann (James's great-great-great-granddaughter). |
| 238 | 61 | Richard Norman (James's great-great-great-grandson). |
| 513 | | WIRTZ, Jesse (Frances Elizabeth Kennedy's sister). |
| 573 | | WOOD, Gideon (Anne Elizabeth Van Orsdel's uncle by marriage). |
| 31 | | WURTZ, Dairld Gean (James's four-times-great-granddaughter's husband). |
| 173 | 28 | YOUNG, Brigid Ann (James's great-great-great-grandson's wife). |